Copyright Notice:

No part of this installation guide may be reproduced, transcribed, transmitted, or translated in any language, in any form or by any means, except duplication of documentation by the purchaser for backup purpose, without written consent of ASRock Inc.

Products and corporate names appearing in this guide may or may not be registered trademarks or copyrights of their respective companies, and are used only for identification or explanation and to the owners' benefit, without intent to infringe.

Disclaimer:

Specifications and information contained in this guide are furnished for informational use only and subject to change without notice, and should not be constructed as a commitment by ASRock. ASRock assumes no responsibility for any errors or omissions that may appear in this guide.

With respect to the contents of this guide, ASRock does not provide warranty of any kind, either expressed or implied, including but not limited to the implied warranties or conditions of merchantability or fitness for a particular purpose. In no event shall ASRock, its directors, officers, employees, or agents be liable for any indirect, special, incidental, or consequential damages (including damages for loss of profits, loss of business, loss of data, interruption of business and the like), even if ASRock has been advised of the possibility of such damages arising from any defect or error in the guide or product.



This device complies with Part 15 of the FCC Rules. Operation is subject to the following two conditions:

- (1) this device may not cause harmful interference, and
- (2) this device must accept any interference received, including interference that may cause undesired operation.

CALIFORNIA, USA ONLY

The Lithium battery adopted on this motherboard contains Perchlorate, a toxic substance controlled in Perchlorate Best Management Practices (BMP) regulations passed by the California Legislature. When you discard the Lithium battery in California, USA, please follow the related regulations in advance.

"Perchlorate Material-special handling may apply, see www.dtsc.ca.gov/hazardouswaste/perchlorate"

ASRock Website: <http://www.asrock.com>

Published July 2012
Copyright©2012 ASRock INC. All rights reserved.

English

Motherboard Layout

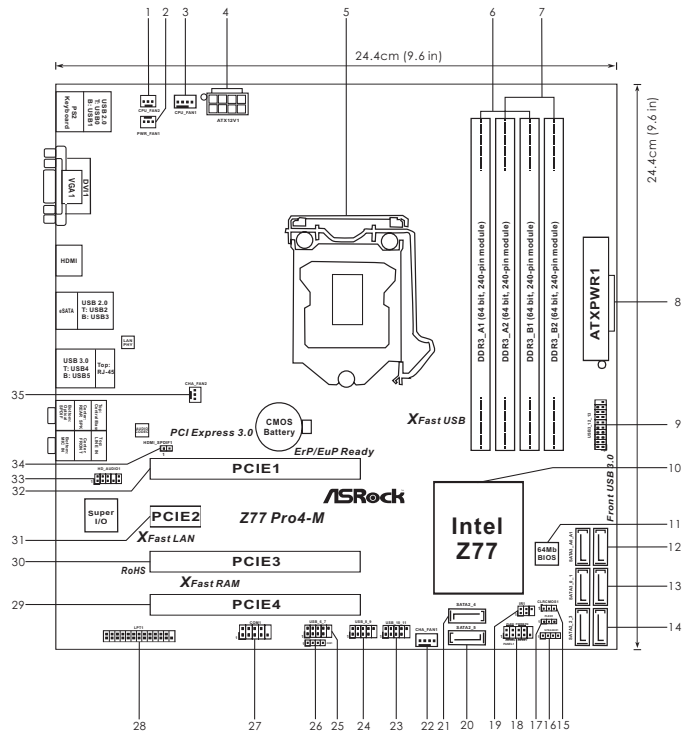

English

- | | | | |
|----|--|----|---|
| 1 | CPU Fan Connector (CPU_FAN2) | 19 | Infrared Module Header (IR1) |
| 2 | Power Fan Connector (PWR_FAN1) | 20 | SATA2 Connector (SATA2_5, Black) |
| 3 | CPU Fan Connector (CPU_FAN1) | 21 | SATA2 Connector (SATA2_4, Black) |
| 4 | ATX 12V Power Connector (ATX12V1) | 22 | Chassis Fan Connector (CHA_FAN1) |
| 5 | 1155-Pin CPU Socket | 23 | USB 2.0 Header (USB_10_11, Black) |
| 6 | 2 x 240-pin DDR3 DIMM Slots
(DDR3_A1, DDR3_B1, Black) | 24 | USB 2.0 Header (USB_8_9, Black) |
| 7 | 2 x 240-pin DDR3 DIMM Slots
(DDR3_A2, DDR3_B2, Black) | 25 | USB 2.0 Header (USB_6_7, Black) |
| 8 | ATX Power Connector (ATXPWR1) | 26 | Consumer Infrared Module Header
(CIR1, Gray) |
| 9 | USB 3.0 Header (USB3_12_13, Black) | 27 | COM Port Header (COM1) |
| 10 | Intel Z77 Chipset | 28 | Print Port Header (LPT1) |
| 11 | SPI Flash Memory (64Mb) | 29 | PCI Express 2.0 x16 Slot (PCIE4, Black) |
| 12 | SATA3 Connectors (SATA3_A0_A1, Gray) | 30 | PCI Express 2.0 x16 Slot (PCIE3, Black) |
| 13 | SATA3 Connectors (SATA3_0_1, Gray) | 31 | PCI Express 2.0 x1 Slot (PCIE2, Black) |
| 14 | SATA2 Connectors (SATA2_2_3, Black) | 32 | PCI Express 3.0 x16 Slot (PCIE1, Black) |
| 15 | Clear CMOS Jumper (CLRCMOS1) | 33 | Front Panel Audio Header
(HD_AUDIO1, Black) |
| 16 | Chassis Speaker Header (SPEAKER1, Black) | 34 | HDMI_SPDIF Header
(HDMI_SPDIF1, Black) |
| 17 | Power LED Header (PLED1) | 35 | Chassis Fan Connector (CHA_FAN2) |
| 18 | System Panel Header (PANEL1, Black) | | |

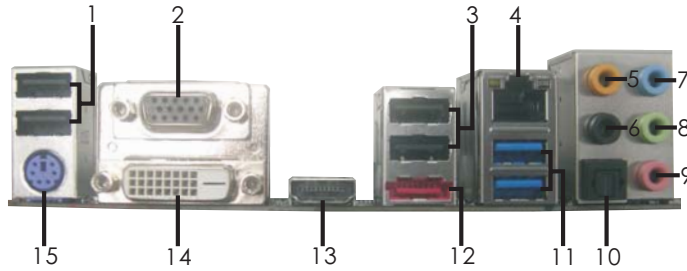

I/O Panel



- | | |
|---------------------------|--------------------------------|
| 1 USB 2.0 Ports (USB01) | 9 Microphone (Pink) |
| 2 D-Sub Port (VGA1) | 10 Optical SPDIF Out Port |
| 3 USB 2.0 Ports (USB23) | 11 USB 3.0 Ports (USB45) |
| * 4 LAN RJ-45 Port | *** 12 eSATA3 Connector |
| 5 Central / Bass (Orange) | 13 HDMI Port (HDMI1) |
| 6 Rear Speaker (Black) | 14 DVI-D Port (DVI1) |
| 7 Line In (Light Blue) | 15 PS/2 Keyboard Port (Purple) |
| ** 8 Front Speaker (Lime) | |

* There are two LED next to the LAN port. Please refer to the table below for the LAN port LED indications.

LAN Port LED Indications

Activity/Link LED		SPEED LED		ACT/LINK LED	SPEED LED
Status	Description	Status	Description	LED	LED
Off	No Link	Off	10Mbps connection		
Blinking	Data Activity	Orange	100Mbps connection		
On	Link	Green	1Gbps connection		

** If you use 2-channel speaker, please connect the speaker's plug into "Front Speaker Jack".
See the table below for connection details in accordance with the type of speaker you use.

TABLE for Audio Output Connection

Audio Output Channels	Front Speaker (No. 8)	Rear Speaker (No. 6)	Central / Bass (No. 5)	Line in (No. 7)
2	V	--	--	--
4	V	V	--	--
6	V	V	V	--
8	V	V	V	V

To enable Multi-Streaming function, you need to connect a front panel audio cable to the front panel audio header. After restarting your computer, you will find "Mixer" tool on your system. Please select "Mixer Toolbox" , click "Enable playback multi-streaming", and click "ok". Choose "2CH", "4CH", "6CH", or "8CH" and then you are allowed to select "Realtek HDA Primary output" to use Rear Speaker, Central/Bass, and Front Speaker, or select "Realtek HDA Audio 2nd output" to use front panel audio.

*** eSATA3 connector supports SATA Gen3 in cable 1M.

1. Introduction

Thank you for purchasing ASRock **Z77 Pro4-M** motherboard, a reliable motherboard produced under ASRock's consistently stringent quality control. It delivers excellent performance with robust design conforming to ASRock's commitment to quality and endurance.

This Quick Installation Guide contains introduction of the motherboard and step-by-step installation guide. More detailed information of the motherboard can be found in the user manual presented in the Support CD.



Because the motherboard specifications and the BIOS software might be updated, the content of this manual will be subject to change without notice. In case any modifications of this manual occur, the updated version will be available on ASRock website without further notice. You may find the latest VGA cards and CPU support lists on ASRock website as well. ASRock website <http://www.asrock.com>
If you require technical support related to this motherboard, please visit our website for specific information about the model you are using.
www.asrock.com/support/index.asp

1.1 Package Contents

ASRock **Z77 Pro4-M** Motherboard

(Micro ATX Form Factor: 9.6-in x 9.6-in, 24.4 cm x 24.4 cm)

ASRock **Z77 Pro4-M** Quick Installation Guide

ASRock **Z77 Pro4-M** Support CD

2 x Serial ATA (SATA) Data Cables (Optional)

1 x I/O Panel Shield



ASRock Reminds You...

To get better performance in Windows® 7 / 7 64-bit / Vista™ / Vista™ 64-bit, it is recommended to set the BIOS option in Storage Configuration to AHCI mode. For the BIOS setup, please refer to the "User Manual" in our support CD for details.

1.2 Specifications

Platform	<ul style="list-style-type: none"> - Micro ATX Form Factor: 9.6-in x 9.6-in, 24.4 cm x 24.4 cm - All Solid Capacitor design (100% Japan-made high-quality Conductive Polymer Capacitors)
CPU	<ul style="list-style-type: none"> - Supports 3rd and 2nd Generation Intel® Core™ i7 / i5 / i3 in LGA1155 Package - Digi Power Design - 4 + 2 Power Phase Design - Supports Intel® Turbo Boost 2.0 Technology - Supports Intel® K-Series unlocked CPU - Supports Hyper-Threading Technology (see CAUTION 1) - Supports Intel® Rapid Start Technology and Smart Connect Technology with Intel® Ivy Bridge CPU
Chipset	- Intel® Z77
Memory	<ul style="list-style-type: none"> - Dual Channel DDR3 Memory Technology (see CAUTION 2) - 4 x DDR3 DIMM slots - Supports DDR3 2800+(OC)/2400(OC)/2133(OC)/1866(OC)/1600/1333/1066 non-ECC, un-buffered memory - Max. capacity of system memory: 32GB (see CAUTION 3) - Supports Intel® Extreme Memory Profile (XMP)1.3/1.2
Expansion Slot	<ul style="list-style-type: none"> - 1 x PCI Express 3.0 x16 slot (PCIE1: x16 mode) (see CAUTION 4) * PCIE 3.0 is only supported with Intel® Ivy Bridge CPU. With Intel® Sandy Bridge CPU, it only supports PCIE 2.0. - 2 x PCI Express 2.0 x16 slots (PCIE3: x1 mode; PCIE4: x4 mode) - 1 x PCI Express 2.0 x 1 slot - Supports AMD Quad CrossFireX™ and CrossFireX™
Graphics	<ul style="list-style-type: none"> * Intel® HD Graphics Built-in Visuals and the VGA outputs can be supported only with processors which are GPU integrated. - Supports Intel® HD Graphics Built-in Visuals: Intel® Quick Sync Video 2.0, Intel® InTru™ 3D, Intel® Clear Video HD Technology, Intel® Insider™, Intel® HD Graphics 2500/4000 - Pixel Shader 5.0, DirectX 11 with Intel® Ivy Bridge CPU. Pixel Shader 4.1, DirectX 10.1 with Intel® Sandy Bridge CPU. - Max. shared memory 1760MB (see CAUTION 5) - Three VGA Output options: D-Sub, DVI-D and HDMI (see CAUTION 6)

	<ul style="list-style-type: none"> - Supports HDMI 1.4a Technology with max. resolution up to 1920x1200 @ 60Hz - Supports DVI with max. resolution up to 1920x1200 @ 60Hz - Supports D-Sub with max. resolution up to 2048x1536 @ 75Hz - Supports Auto Lip Sync, Deep Color (12bpc), xvYCC and HBR (High Bit Rate Audio) with HDMI (Compliant HDMI monitor is required) (see CAUTION 7) - Supports HDCP function with DVI and HDMI ports - Supports Full HD 1080p Blu-ray (BD) / HD-DVD playback with DVI and HDMI ports
Audio	<ul style="list-style-type: none"> - 7.1 CH HD Audio with Content Protection (Realtek ALC892 Audio Codec) - Premium Blu-ray audio support - Supports THX TruStudio™
LAN	<ul style="list-style-type: none"> - PCIE x1 Gigabit LAN 10/100/1000 Mb/s - Realtek RTL8111E - Supports Wake-On-LAN - Supports LAN Cable Detection - Supports Energy Efficient Ethernet 802.3az - Supports PXE
Rear Panel I/O	<p>I/O Panel</p> <ul style="list-style-type: none"> - 1 x PS/2 Keyboard Port - 1 x D-Sub Port - 1 x DVI-D Port - 1 x HDMI Port - 1 x Optical SPDIF Out Port - 4 x Ready-to-Use USB 2.0 Ports - 1 x eSATA3 Connector - 2 x Ready-to-Use USB 3.0 Ports - 1 x RJ-45 LAN Port with LED (ACT/LINK LED and SPEED LED) - HD Audio Jack: Rear Speaker/Central/Bass/Line in/Front Speaker/Microphone (see CAUTION 8)
SATA3	<ul style="list-style-type: none"> - 2 x SATA3 6.0 Gb/s connectors by Intel® Z77, support RAID (RAID 0, RAID 1, RAID 5, RAID 10, Intel Rapid Storage and Intel Smart Response Technology), NCQ, AHCI and Hot Plug functions - 2 x SATA3 6.0 Gb/s connectors by ASMedia ASM1061, support NCQ, AHCI and Hot Plug functions (SATA3_A1 connector is shared with eSATA3 port)

English

USB3.0	<ul style="list-style-type: none"> - 2 x Rear USB 3.0 ports, support USB 1.0/2.0/3.0 up to 5Gb/s - 1 x Front USB 3.0 header (supports 2 USB 3.0 ports), supports USB 1.0/2.0/3.0 up to 5Gb/s
Connector	<ul style="list-style-type: none"> - 4 x SATA2 3.0 Gb/s connectors, support RAID (RAID 0, RAID 1, RAID 5, RAID 10, Intel Rapid Storage and Intel Smart Response Technology), NCQ, AHCI and Hot Plug functions - 4 x SATA3 6.0Gb/s connectors - 1 x IR header - 1 x CIR header - 1 x Print port header - 1 x COM port header - 1 x HDMI_SPDIF header - 1 x Power LED header - CPU/Chassis/Power FAN connector - 24 pin ATX power connector - 8 pin 12V power connector - Front panel audio connector - 3 x USB 2.0 headers (support 6 USB 2.0 ports) - 1 x USB 3.0 header (supports 2 USB 3.0 ports)
BIOS Feature	<ul style="list-style-type: none"> - 64Mb AMI UEFI Legal BIOS with GUI support - Supports "Plug and Play" - ACPI 1.1 Compliance Wake Up Events - Supports jumperfree - SMBIOS 2.3.1 Support - CPU Core, IGPU, DRAM, 1.8V PLL, VTT, VCCSA Voltage Multi-adjustment
Support CD	<ul style="list-style-type: none"> - Drivers, Utilities, AntiVirus Software (Trial Version), CyberLink MediaEspresso 6.5 Trial, ASRock MAGIX Multimedia Suite - OEM
Unique Feature	<ul style="list-style-type: none"> - ASRock Extreme Tuning Utility (AXTU) (see CAUTION 9) - ASRock Instant Boot - ASRock Instant Flash (see CAUTION 10) - ASRock APP Charger (see CAUTION 11) - ASRock SmartView (see CAUTION 12) - ASRock XFast USB (see CAUTION 13) - ASRock XFast LAN (see CAUTION 14) - ASRock XFast RAM (see CAUTION 15) - ASRock Crashless BIOS (see CAUTION 16) - ASRock OMG (Online Management Guard) (see CAUTION 17)

	<ul style="list-style-type: none"> - Lucid Virtu Universal MVP (see CAUTION 18) * Lucid Virtu Universal MVP can be supported only with processors which are GPU integrated. - ASRock On/Off Play Technology (see CAUTION 19) - Hybrid Booster: <ul style="list-style-type: none"> - CPU Frequency Stepless Control (see CAUTION 20) - ASRock U-COP (see CAUTION 21) - Boot Failure Guard (B.F.G.) - Combo Cooler Option (C.C.O.) (see CAUTION 22) - Good Night LED
Hardware Monitor	<ul style="list-style-type: none"> - CPU Temperature Sensing - Chassis Temperature Sensing - CPU/Chassis/Power Fan Tachometer - CPU/Chassis Quiet Fan (Allows Chassis Fan Speed Auto-Adjust by CPU Temperature) - CPU/Chassis Fan Multi-Speed Control - Voltage Monitoring: +12V, +5V, +3.3V, CPU Vcore
OS	<ul style="list-style-type: none"> - Microsoft® Windows® 7 / 7 64-bit / Vista™ / Vista™ 64-bit / XP / XP 64-bit compliant (see CAUTION 23)
Certifications	<ul style="list-style-type: none"> - FCC, CE, WHQL - ErP/EuP Ready (ErP/EuP ready power supply is required) (see CAUTION 24)

* For detailed product information, please visit our website: <http://www.asrock.com>

WARNING

Please realize that there is a certain risk involved with overclocking, including adjusting the setting in the BIOS, applying Untied Overclocking Technology, or using third-party overclocking tools. Overclocking may affect your system's stability, or even cause damage to the components and devices of your system. It should be done at your own risk and expense. We are not responsible for possible damage caused by overclocking.

English

CAUTION!

1. About the settings of "Hyper Threading Technology", please check page 52 of the "User Manual" in the support CD.
2. This motherboard supports Dual Channel Memory Technology. Before you implement Dual Channel Memory Technology, make sure to read the installation guide of memory modules on page 17 for proper installation.
3. Due to the operating system limitation, the actual memory size may be less than 4GB for the reservation for system usage under Windows® 7 / Vista™ / XP. For Windows® OS with 64-bit CPU, there is no such limitation. You can use ASRock XFast RAM to utilize the memory that Windows® cannot use.
4. Only PCIe1 slot supports Gen 3 speed. To run the PCI Express in Gen 3 speed, please install an Ivy Bridge CPU. If you install a Sandy Bridge CPU, the PCI Express will run only at PCI Express Gen 2 speed.
5. The maximum shared memory size is defined by the chipset vendor and is subject to change. Please check Intel® website for the latest information.
6. You can choose to use two of the three monitors only. D-Sub, DVI-D and HDMI monitors cannot be enabled at the same time. Besides, with the DVI-to-HDMI adapter, the DVI-D port can support the same features as the HDMI port.
7. xvYCC and Deep Color are only supported under Windows® 7 64-bit / 7. Deep Color mode will be enabled only if the display supports 12bpc in EDID. HBR is supported under Windows® 7 64-bit / 7 / Vista™ 64-bit / Vista™.
8. For microphone input, this motherboard supports both stereo and mono modes. For audio output, this motherboard supports 2-channel, 4-channel, 6-channel, and 8-channel modes. Please check the table on page 3 for proper connection.
9. ASRock Extreme Tuning Utility (AXTU) is an all-in-one tool to re-tune different system functions in a user-friendly interface, which includes Hardware Monitor, Fan Control, Overclocking, OC DNA and IES. In Hardware Monitor, it shows the major readings of your system. In Fan Control, it shows the fan speed and temperature for you to adjust. In Overclocking, you are allowed to overclock CPU frequency for optimal system performance. In OC DNA, you can save your OC settings as a profile and share it with your friends. Your friends then can load the OC profile to their own system to get the same OC settings. In IES (Intelligent Energy Saver), the voltage regulator can reduce the number of output phases to improve efficiency when the CPU cores are idle without sacrificing computing performance. Please visit our website for the operation procedures of ASRock Extreme Tuning Utility (AXTU).
ASRock website: <http://www.asrock.com>
10. ASRock Instant Flash is a BIOS flash utility embedded in Flash ROM. This convenient BIOS update tool allows you to update system BIOS without entering operating systems first like MS-DOS or Windows®. With

this utility, you can press the <F6> key during the POST or the <F2> key to enter into the BIOS setup menu to access ASRock Instant Flash. Just launch this tool and save the new BIOS file to your USB flash drive, floppy disk or hard drive, then you can update your BIOS only in a few clicks without preparing an additional floppy diskette or other complicated flash utility. Please be noted that the USB flash drive or hard drive must use FAT32/16/12 file system.

11. If you desire a faster, less restricted way of charging your Apple devices, such as iPhone/iPad/iPod Touch, ASRock has prepared a wonderful solution for you - ASRock APP Charger. Simply install the APP Charger driver, it makes your iPhone charge much quickly from your computer and up to 40% faster than before. ASRock APP Charger allows you to quickly charge many Apple devices simultaneously and even supports continuous charging when your PC enters into Standby mode (S1), Suspend to RAM (S3), hibernation mode (S4) or power off (S5). With APP Charger driver installed, you can easily enjoy the marvelous charging experience. ASRock website: <http://www.asrock.com/Feature/AppCharger/index.asp>
12. ASRock SmartView, a new function for internet browsers, is the smart start page for IE that combines your most visited web sites, your history, your Facebook friends and your real-time newsfeed into an enhanced view for a more personal Internet experience. ASRock motherboards are exclusively equipped with the ASRock SmartView utility that helps you keep in touch with friends on-the-go. To use ASRock SmartView feature, please make sure your OS version is Windows® 7 / 7 64 bit / Vista™ / Vista™ 64 bit, and your browser version is IE8. ASRock website: <http://www.asrock.com/Feature/SmartView/index.asp>
13. ASRock XFast USB can boost USB storage device performance. The performance may depend on the properties of the device.
14. ASRock XFast LAN provides a faster internet access, which includes the benefits listed below. LAN Application Prioritization: You can configure your application's priority ideally and/or add new programs. Lower Latency in Game: After setting online game's priority higher, it can lower the latency in games. Traffic Shaping: You can watch Youtube HD videos and download simultaneously. Real-Time Analysis of Your Data: With the status window, you can easily recognize which data streams you are transferring currently.
15. ASRock XFast RAM is a new function that is included into ASRock Extreme Tuning Utility (AXTU). It fully utilizes the memory space that cannot be used under Windows® OS 32-bit CPU. ASRock XFast RAM shortens the loading time of previously visited websites, making web surfing faster than ever. And it also boosts the speed of Adobe Photoshop 5 times faster. Another advantage of ASRock XFast RAM is that it reduces the frequency of accessing your SSDs or HDDs in order to extend their lifespan.
16. ASRock Crashless BIOS allows users to update their BIOS without fear of failing. If power loss occurs during the BIOS update process, ASRock

Crashless BIOS will automatically finish the BIOS update procedure after regaining power. Please note that BIOS files need to be placed in the root directory of your USB disk. Only USB2.0 ports support this feature.

17. Administrators are able to establish an internet curfew or restrict internet access at specified times via OMG. You may choose from [Everyday], [Day of the week] or [Weekdays and weekends], then schedule the starting and ending hours of internet access granted to other users. In order to prevent users from bypassing OMG, guest accounts without permission to modify the system time are required.
18. VIRTU Universal MVP includes the base features of Virtu Universal technology, which virtualizes integrated GPU and discrete GPU for best of breed functionality. It also features Virtual Vsync™ for no-compromise visual quality. With the added benefits of HyperFormance technology, VIRTU Universal MVP improves game performance by intelligently reducing redundant rendering tasks in the flow between the CPU, GPU and the display.
19. ASRock On/Off Play Technology allows users to enjoy the great audio experience from the portable audio devices, such like MP3 player or mobile phone to your PC, even when the PC is turned off (or in ACPI S5 mode)! This motherboard also provides a free 3.5mm audio cable (optional) that ensures users the most convenient computing environment.
20. Although this motherboard offers stepless control, it is not recommended to perform over-clocking. Frequencies other than the recommended CPU bus frequencies may cause instability of the system or damage the CPU.
21. While CPU overheat is detected, the system will automatically shutdown. Before you resume the system, please check if the CPU fan on the motherboard functions properly and unplug the power cord, then plug it back again. To improve heat dissipation, remember to spray thermal grease between the CPU and the heatsink when you install the PC system.
22. Combo Cooler Option (C.C.O.) provides the flexible option to adopt three different CPU cooler types, Socket LGA 775, LGA 1155 and LGA 1156. Please be noticed that not all the 775 and 1156 CPU Fan can be used.
23. ASRock XFast RAM is not supported by Microsoft® Windows® XP / XP 64-bit. Intel® Smart Connect Technology and Intel® USB 3.0 ports are not supported by Microsoft® Windows® Vista™ / Vista™ 64-bit / XP / XP 64-bit.
24. EuP stands for Energy Using Product, was a provision regulated by the European Union to define the power consumption for the completed system. According to EuP, the total AC power of the completed system should be under 1.00W in off mode condition. To meet EuP standards, an EuP ready motherboard and an EuP ready power supply are required. According to Intel's suggestion, the EuP ready power supply must meet the standard of 5v, and the standby power efficiency should be higher than 50% under 100 mA current consumption. For EuP ready power supply selection, we recommend you to check with the power supply manufacturer for more details.

Chapter 2: Installation

This is a micro ATX form factor (9.6" x 9.6", 24.4 x 24.4 cm) motherboard. Before you install the motherboard, study the configuration of your chassis to ensure that the motherboard fits into it.



Make sure to unplug the power cord before installing or removing the motherboard. Failure to do so may cause physical injuries to you and damages to motherboard components.

2.1 Screw Holes

Place screws into the holes indicated by circles to secure the motherboard to the chassis.



Do not over-tighten the screws! Doing so may damage the motherboard.

2.2 Pre-installation Precautions

Take note of the following precautions before you install motherboard components or change any motherboard settings.

1. Unplug the power cord from the wall socket before touching any components.
2. To avoid damaging the motherboard's components due to static electricity, NEVER place your motherboard directly on the carpet or the like. Also remember to use a grounded wrist strap or touch a safety grounded object before you handle the components.
3. Hold components by the edges and do not touch the ICs.
4. Whenever you uninstall any component, place it on a grounded anti-static pad or in the bag that comes with the component.
5. When placing screws into the screw holes to secure the motherboard to the chassis, please do not over-tighten the screws! Doing so may damage the motherboard.



Before you install or remove any component, ensure that the power is switched off or the power cord is detached from the power supply. Failure to do so may cause severe damage to the motherboard, peripherals, and/or components.

English

2.3 CPU Installation

In order to provide the LGA 1155 CPU sockets more protection and make the installation process easier, ASRock has added a new protection cover on top of the load plate to replace the former PnP caps that were under the load plate. For the installation of Intel® 1155-Pin CPUs with the new protection cover, please follow the steps below.

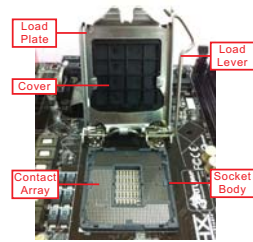

1155-Pin Socket Overview



Before you insert the 1155-Pin CPU into the socket, please check if the CPU surface is unclean or if there are any bent pins in the socket. Do not force to insert the CPU into the socket if above situation is found. Otherwise, the CPU will be seriously damaged.

Step 1. Open the socket:

Step 1-1. Disengage the lever by pressing it down and sliding it out of the hook. You do not have to remove the protection cover.



Step 1-2. Keep the lever positioned at about 135 degrees in order to flip up the load plate.



Step 2. Insert the 1155-Pin CPU:

Step 2-1. Hold the CPU by the edge which is marked with a black line.

Step 2-2. Orient the CPU with the IHS (Integrated Heat Sink) up. Locate Pin1 and the two orientation key notches.



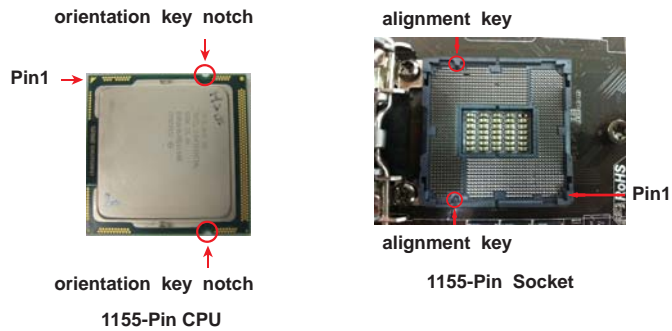

For proper installation, please ensure to match the two orientation key notches of the CPU with the two alignment keys of the socket.

Step 2-3. Carefully place the CPU into the socket.



Step 2-4. Verify that the CPU is within the socket and properly mated to the orientation keys.

Step 3. Close the socket:

Step 3-1. Flip the load plate onto the IHS.



Step 3-2. Press down the load lever, and secure it with the load plate tab under the retention tab. The protection cover will automatically come off by itself.



Please save and replace the cover if the processor is removed. The cover must be placed if you wish to return the motherboard for after service.

English

2.4 Installation of CPU Fan and Heatsink

This motherboard is equipped with 1155-Pin socket that supports Intel 1155-Pin CPUs. Please adopt the type of heatsink and cooling fan compliant with Intel 1155-Pin CPU to dissipate heat. Before you install the heatsink, you need to spray thermal interface material between the CPU and the heatsink to improve heat dissipation. Ensure that the CPU and the heatsink are securely fastened and in good contact with each other. Then connect the CPU fan to the CPU_FAN connector (CPU_FAN1, see page 2, No. 3 or CPU_FAN2, see page 2, No.1).

For proper installation, please kindly refer to the instruction manuals of your CPU fan and heatsink.

Below is an example to illustrate the installation of the heatsink for 1155-Pin CPUs.

Step 1. Apply thermal interface material onto the center of the IHS on the socket's surface.



Step 2. Place the heatsink onto the socket. Ensure that the fan cables are oriented on side closest to the CPU fan connector on the motherboard (CPU_FAN1, see page 2, No. 3 or CPU_FAN2, see page 2, No.1).

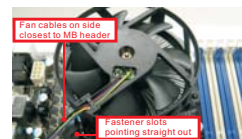

Step 3. Align fasteners with the motherboard through-holes.

Step 4. Rotate the fastener clockwise, then press down on fastener caps with thumb to install and lock. Repeat with remaining fasteners.



If you press down the fasteners without rotating them clockwise, the heatsink cannot be secured on the motherboard.

Step 5. Connect fan header with the CPU fan connector on the motherboard.

Step 6. Secure redundant cable with tie-wrap to ensure the cable does not interfere with fan operation or contact other components.



Please be noticed that this motherboard supports Combo Cooler Option (C.C.O.), which provides flexible options to adopt three different CPU cooler types, Socket LGA 775, LGA 1155 and LGA 1156. The white throughholes are for Socket LGA 1155/1156 CPU fan.



2.5 Installation of Memory Modules (DIMM)

This motherboard provides four 240-pin DDR3 (Double Data Rate 3) DIMM slots, and supports Dual Channel Memory Technology. For dual channel configuration, you always need to install **identical** (the same brand, speed, size and chip-type) DDR3 DIMM pair in the slots: You have to install **identical** DDR3 DIMMs in **Dual Channel A** (DDR3_A1 and DDR3_B1; Black slots; see p.2 No. 6) or **identical** DDR3 DIMMs in **Dual Channel B** (DDR3_A2 and DDR3_B2; Black slots; see p.2 No. 7), so that Dual Channel Memory Technology can be activated. This motherboard also allows you to install four DDR3 DIMMs for dual channel configuration, please install **identical** DDR3 DIMMs in all four slots. You may refer to the Dual Channel Memory Configuration Table below.

Dual Channel Memory Configuration

	DDR3_A1 (Black Slot)	DDR3_A2 (Black Slot)	DDR3_B1 (Black Slot)	DDR3_B2 (Black Slot)
(1)	Populated	-	Populated	-
(2)	-	Populated	-	Populated
(3)*	Populated	Populated	Populated	Populated

* For configuration (3), please install **identical** DDR3 DIMMs in all four slots.



1. If you want to install two memory modules, for optimal compatibility and reliability, it is recommended to install them in the slots: DDR3_A1 and DDR3_B1, or DDR3_A2 and DDR3_B2.
2. If only one memory module or three memory modules are installed in the DDR3 DIMM slots on this motherboard, it is unable to activate Dual Channel Memory Technology.
3. If a pair of memory modules is NOT installed in the same Dual Channel, for example, installing a pair of memory modules in DDR3_A1 and DDR3_A2, it is unable to activate Dual Channel Memory Technology.
4. It is not allowed to install a DDR or DDR2 memory module into DDR3 slot; otherwise, this motherboard and DIMM may be damaged.
5. Some DDR3 1GB double-sided DIMMs with 16 chips may not work on this motherboard. It is not recommended to install them on this motherboard.
6. For optimal compatibility and stability while overclocking memory frequency, it is recommended to install one memory module in DDR3_B2 slot or two memory modules in DDR3_A2 and DDR3_B2 slots.

Installing a DIMM



Please make sure to disconnect power supply before adding or removing DIMMs or the system components.

- Step 1. Unlock a DIMM slot by pressing the retaining clips outward.
- Step 2. Align a DIMM on the slot such that the notch on the DIMM matches the break on the slot.



The DIMM only fits in one correct orientation. It will cause permanent damage to the motherboard and the DIMM if you force the DIMM into the slot in incorrect orientation.

- Step 3. Firmly insert the DIMM into the slot until the retaining clips at both ends fully snap back in place and the DIMM is properly seated.

2.6 Expansion Slots (PCI Express Slots)

There are 4 PCI Express slots on this motherboard.

PCIe slots: PCIe1 (PCIe 3.0 x16 slot) is used for PCI Express x16 lane width graphics cards, or to install PCI Express graphics cards to support CrossFireX™ function.

PCIe2 (PCIe 2.0 x1 slot) is used for a PCI Express x1 lane width card, such as a Gigabit LAN card or SATA2 card, etc.

PCIe3 (PCIe 2.0 x16 slot) is used for PCI Express x1 lane width graphics cards.

PCIe4 (PCIe 2.0 x16 slot) is used for PCI Express x4 lane width graphics cards, or to install PCI Express graphics cards to support CrossFireX™ function. And for installing ASRock Game Blaster.



1. In single VGA card mode, it is recommended to install a PCI Express x16 graphics card on PCIe1 slot.
2. In CrossFireX™ mode, please install the PCI Express x16 graphics cards on PCIe1 and PCIe4 slots. Therefore, PCIe1 will work at x16 bandwidth, while PCIe4 works at x4 bandwidth.
3. Please connect a chassis fan to the motherboard's chassis fan connector (CHA_FAN1 or CHA_FAN2) when using multiple graphics cards for better thermal environment.
4. Only PCIe1 slot supports Gen 3 speed. To run the PCI Express in Gen 3 speed, please install an Ivy Bridge CPU. If you install a Sandy Bridge CPU, the PCI Express will run only at PCI Express Gen 2 speed.

Installing an expansion card

- Step 1. Before installing an expansion card, please make sure that the power supply is switched off or the power cord is unplugged. Please read the documentation of the expansion card and make necessary hardware settings for the card before you start the installation.
- Step 2. Remove the system unit cover (if your motherboard is already installed in a chassis).
- Step 3. Remove the bracket facing the slot that you intend to use. Keep the screws for later use.
- Step 4. Align the card connector with the slot and press firmly until the card is completely seated on the slot.
- Step 5. Fasten the card to the chassis with screws.
- Step 6. Replace the system cover.

2.7 CrossFireX™ and Quad CrossFireX™ Operation Guide

This motherboard supports CrossFireX™ and Quad CrossFireX™. CrossFireX™ technology offers the most advantageous means available of combining multiple high performance Graphics Processing Units (GPU) in a single PC. Combining a range of different operating modes with intelligent software design and an innovative interconnect mechanism, CrossFireX™ enables the highest possible level of performance and image quality in any 3D application. Currently CrossFireX™ is supported by Windows® XP with Service Pack 2 / Vista™ / 7 OS. Quad CrossFireX™ is supported by Windows® Vista™ / 7 OS only. Please check AMD's website for AMD CrossFireX™ driver updates.



1. If a customer incorrectly configures their system they will not see the performance benefits of CrossFireX™. All three CrossFireX™ components, a CrossFireX™ Ready graphics card, a CrossFireX™ Ready motherboard and a CrossFireX™ Edition co-processor graphics card, must be installed correctly to benefit from the CrossFireX™ multi-GPU platform.
2. If you pair a 12-pipe CrossFireX™ Edition card with a 16-pipe card, both cards will operate as 12-pipe cards while in CrossFireX™ mode.

2.7.1 Installing Two CrossFireX™-Ready Graphics Cards



Different CrossFireX™ cards may require different methods to enable CrossFireX™ feature. For other CrossFireX™ cards that AMD has released or will release in the future, please refer to AMD graphics card manuals for detailed installation guide.

- Step 1. Insert one Radeon graphics card into PCIE1 slot and the other Radeon graphics card to PCIE4 slot. Make sure that the cards are properly seated on the slots.



Step 2. Connect two Radeon graphics cards by installing a CrossFire Bridge on the CrossFire Bridge Interconnects on the top of the Radeon graphics cards. (The CrossFire Bridge is provided with the graphics card you purchase, not bundled with this motherboard. Please refer to your graphics card vendor for details.)



CrossFire Bridge

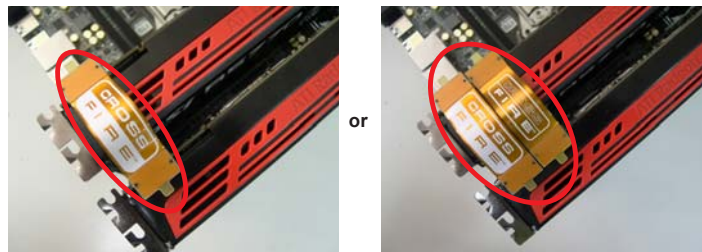

Step 3. Connect the DVI monitor cable to the DVI connector on the Radeon graphics card on PCIE1 slot. (You may use the DVI to D-Sub adapter to convert the DVI connector to D-Sub interface, and then connect the D-Sub monitor cable to the DVI to D-Sub adapter.)

2.7.2 Driver Installation and Setup

- Step 1. Power on your computer and boot into OS.
Step 2. Remove the AMD drivers if you have any VGA drivers installed in your system.



The Catalyst Uninstaller is an optional download. We recommend using this utility to uninstall any previously installed Catalyst drivers prior to installation. Please check AMD's website for AMD driver updates.

- Step 3. Install the required drivers to your system.

For Windows® XP OS:

A. AMD recommends Windows® XP Service Pack 2 or higher to be installed (If you have Windows® XP Service Pack 2 or higher installed in your system, there is no need to download it again):

<http://www.microsoft.com/windowsxp/sp2/default.msp>

B. You must have Microsoft .NET Framework installed prior to downloading and installing the CATALYST Control Center. Please check Microsoft's website for details.

For Windows® 7 / Vista™ OS:

Install the CATALYST Control Center. Please check AMD's website for details.

- Step 4. Restart your computer.
Step 5. Install the VGA card drivers to your system, and restart your computer. You will find "AMD Catalyst Control Center" on your Windows® taskbar.



AMD Catalyst Control Center

- Step 6. Double-click "ATI Catalyst Control Center". Click "View", select "CrossFireX™", and then check the item "Enable CrossFireX™". Select "2 GPUs" and click "Apply".

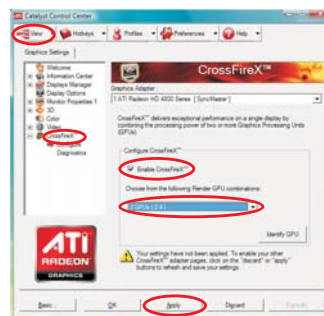



Although you have selected the option "Enable CrossFire™", the CrossFire™ function may not work actually. Your computer will automatically reboot. After restarting your computer, please confirm whether the option "Enable CrossFire™" in "ATI Catalyst Control Center" is selected or not; if not, please select it again, and then you are able to enjoy the benefits of CrossFire™.

Step 7. You can freely enjoy the benefits of CrossFire™ or Quad CrossFire™.

* CrossFire™ appearing here is a registered trademark of AMD Technologies Inc., and is used only for identification or explanation and to the owners' benefit, without intent to infringe.

* For further information of AMD CrossFire™ technology, please check AMD's website for updates and details.

2.8 Dual Monitor and Surround Display Features

Dual Monitor Feature

This motherboard supports dual monitor feature. With the internal VGA output support (DVI-D, D-Sub and HDMI), you can easily enjoy the benefits of dual monitor feature without installing any add-on VGA cards to this motherboard. This motherboard also provides independent display controllers for DVI-D, D-Sub and HDMI to support dual VGA output so that DVI-D, D-sub and HDMI can drive same or different display contents.

To enable dual monitor feature, please follow the steps below:

1. Connect a DVI-D monitor cable to the DVI-D port on the I/O panel, connect a D-Sub monitor cable to the D-Sub port on the I/O panel and connect a HDMI monitor cable to the HDMI port on the I/O panel.

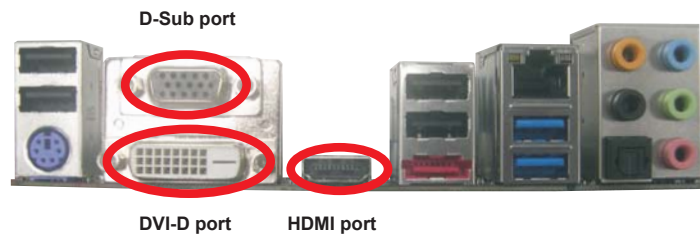

2. If you have already installed the onboard VGA driver from our support CD to your system, you can freely enjoy the benefits of dual monitor function after your system boots. If you haven't installed the onboard VGA driver yet, please install the onboard VGA driver from our support CD to your system and restart your computer.



D-Sub, DVI-D and HDMI monitors cannot be enabled at the same time. You can only choose the combination: DVI-D + HDMI, DVI-D + D-Sub, or HDMI + D-Sub.

Surround Display Feature

This motherboard supports surround display upgrade. With the internal VGA output support (DVI-D, D-Sub and HDMI) and external add-on PCI Express VGA cards, you can easily enjoy the benefits of surround display feature.

Please refer to the following steps to set up a surround display environment:

1. Install the PCI Express VGA cards on PCIE1 and PCIE4 slots. Please refer to page 19 for proper expansion card installation procedures.
2. Connect a DVI-D monitor cable to the DVI-D port on the I/O panel, connect a D-Sub monitor cable to the D-Sub port on the I/O panel and connect a HDMI monitor cable to the HDMI port on the I/O panel. Then connect other monitor cables to the corresponding connectors of the add-on PCI Express VGA cards on PCIE1 and PCIE4 slots.
3. Boot your system. Press <F2> or to enter UEFI setup. Enter "Share Memory" option to adjust the memory capability to [32MB], [64MB], [128MB], [256MB] or [512MB] to enable the function of D-sub. Please make sure that the value you select is less than the total capability of the system memory. If you do not adjust the UEFI setup, the default value of "Share Memory", [Auto], will disable D-Sub function when an add-on VGA card is inserted to this motherboard.
4. Install the onboard VGA driver and the add-on PCI Express VGA card driver to your system. If you have installed the drivers already, there is no need to install them again.
5. Set up a multi-monitor display.

For Windows® XP / XP 64-bit OS:

Right click on desktop, choose "Properties", and select the "Settings" tab so that you can adjust the parameters of the multi-monitors according to the steps below.

- A. Click the "Identify" button to display a large number on each monitor.
- B. Right-click the display icon in the Display Properties dialog that you wish to be your primary monitor, and then select "Primary". When you use multiple monitors with your card, one monitor will always be Primary, and all additional monitors will be designated as Secondary.
- C. Select the display icon identified by the number 2.
- D. Click "Extend my Windows desktop onto this monitor".
- E. Right-click the display icon and select "Attached", if necessary.
- F. Set the appropriate "Screen Resolution" and "Color Quality" for the second monitor. Click "Apply" or "OK" to apply these new values.
- G. Repeat steps C through E for the display icon identified by the numbers three to six.

For Windows® 7 / 7 64-bit / Vista™ / Vista™ 64-bit OS:

Right click the desktop, choose "Personalize", and select the "Display Settings" tab so that you can adjust the parameters of the multi-monitors according to the steps below.

- A. Click the number "2" icon.
 - B. Click the items "This is my main monitor" and "Extend the desktop onto this monitor".
 - C. Click "OK" to save your change.
 - D. Repeat steps A through C for the display icons identified by the number three to six.
6. Use Surround Display. Click and drag the display icons to positions representing the physical setup of your monitors that you would like to use. The placement of display icons determines how you move items from one monitor to another.

**HDCP Function**

HDCP function is supported on this motherboard. To use HDCP function with this motherboard, you need to adopt a monitor that supports HDCP function as well. Therefore, you can enjoy the superior display quality with high-definition HDCP encryption contents. Please refer to the instructions below for more details about HDCP function.

What is HDCP?

HDCP stands for High-Bandwidth Digital Content Protection, a specification developed by Intel® for protecting digital entertainment content that uses the DVI interface. HDCP is a copy protection scheme to eliminate the possibility of intercepting digital data midstream between the video source, or transmitter - such as a computer, DVD player or set-top box - and the digital display, or receiver - such as a monitor, television or projector. In other words, HDCP specification is designed to protect the integrity of content as it is being transmitted.

Products compatible with the HDCP scheme such as DVD players, satellite and cable HDTV set-top-boxes, as well as few entertainment PCs requires a secure connection to a compliant display. Due to the increase in manufacturers employing HDCP in their equipment, it is highly recommended that the HDTV or LCD monitor you purchase is compatible.

2.9 ASRock Smart Remote Installation Guide

ASRock Smart Remote is only used for ASRock motherboards with CIR header. Please refer to below procedures for the quick installation and usage of ASRock Smart Remote.

Step1. Find the CIR header located next to the USB 2.0 header on ASRock motherboard.



Step2. Connect the front USB cable to the USB 2.0 header (as below, pin 1-5) and the CIR header. Please make sure the wire assignments and the pin assignments are matched correctly.

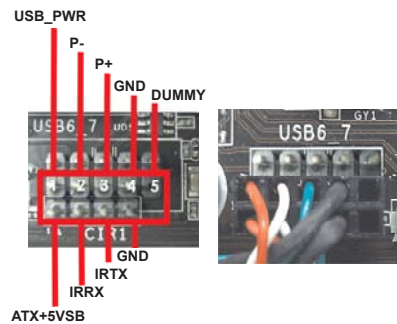

Step3. Install Multi-Angle CIR Receiver to the front USB port. If Multi-Angle CIR Receiver cannot successfully receive the infrared signals from MCE Remote Controller, please try to install it to the other front USB port.



3 CIR sensors in different angles



1. Only one of the front USB port can support CIR function. When the CIR function is enabled, the other port will remain USB function.
2. Multi-Angle CIR Receiver is used for front USB only. Please do not use the rear USB bracket to connect it on the rear panel. Multi-Angle CIR Receiver can receive the multi-direction infrared signals (top, down and front), which is compatible with most of the chassis on the market.
3. The Multi-Angle CIR Receiver does not support Hot-Plug function. Please install it before you boot the system.



* ASRock Smart Remote is only supported by some of ASRock's motherboards. Please refer to ASRock's website for the motherboard support list: <http://www.asrock.com>

English

2.10 Jumpers Setup

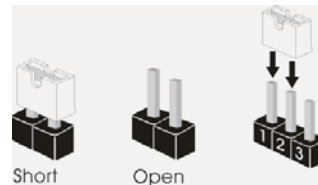
The illustration shows how jumpers are setup. When the jumper cap is placed on pins, the jumper is "Short". If no jumper cap is placed on pins, the jumper is "Open". The illustration shows a 3-pin jumper whose pin1 and pin2 are "Short" when jumper cap is placed on these 2 pins.



Jumper	Setting	Description
Clear CMOS Jumper (CLRCMOS1) (see p.2, No. 15)	<div style="display: flex; justify-content: space-around;"> <div style="text-align: center;"> 1_2  Default </div> <div style="text-align: center;"> 2_3  Clear CMOS </div> </div>	

Note: CLRCMOS1 allows you to clear the data in CMOS. To clear and reset the system parameters to default setup, please turn off the computer and unplug the power cord from the power supply. After waiting for 15 seconds, use a jumper cap to short pin2 and pin3 on CLRCMOS1 for 5 seconds. However, please do not clear the CMOS right after you update the BIOS. If you need to clear the CMOS when you just finish updating the BIOS, you must boot up the system first, and then shut it down before you do the clear-CMOS action. Please be noted that the password, date, time, user default profile, 1394 GUID and MAC address will be cleared only if the CMOS battery is removed.

2.11 Onboard Headers and Connectors



Onboard headers and connectors are NOT jumpers. Do NOT place jumper caps over these headers and connectors. Placing jumper caps over the headers and connectors will cause permanent damage of the motherboard!

Serial ATA2 Connectors

(SATA2_2_3: see p.2, No. 14)

(SATA2_4: see p.2, No. 21)

(SATA2_5: see p.2, No. 20)

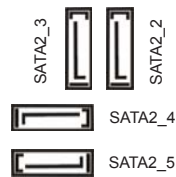

These four Serial ATA2 (SATA2) connectors support SATA data cables for internal storage devices. The current SATA2 interface allows up to 3.0 Gb/s data transfer rate.

Serial ATA3 Connectors

(SATA3_A0_A1: see p.2, No. 12)

(SATA3_0_1: see p.2, No. 13)

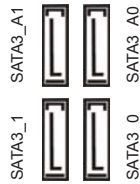

These four Serial ATA3 (SATA3) connectors support SATA data cables for internal storage devices. The current SATA3 interface allows up to 6.0 Gb/s data transfer rate. If the eSATA3 port on the rear I/O has been connected, the internal SATA3_A1 will not function.

Serial ATA (SATA)

Data Cable

(Optional)



Either end of the SATA data cable can be connected to the SATA / SATA2 / SATA3 hard disk or the SATA2 / SATA3 connector on this motherboard.

Print Port Header

(25-pin LPT1)

(see p.2, No. 28)

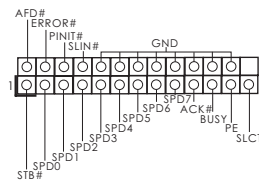

This is an interface for print port cable that allows convenient connection of printer devices.

English

USB 2.0 Headers

(9-pin USB_6_7)

(see p.2, No. 25)

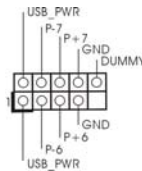

Besides four default USB 2.0 ports on the I/O panel, there are three USB 2.0 headers on this motherboard. Each USB 2.0 header can support two USB 2.0 ports.

(9-pin USB_8_9)

(see p.2, No. 24)

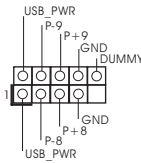

(9-pin USB_10_11)

(see p.2, No. 23)

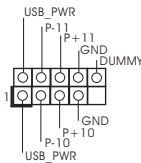
**USB 3.0 Header**

(19-pin USB3_12_13)

(see p.2, No. 9)

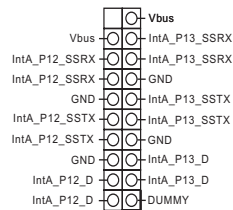

Besides two default USB 3.0 ports on the I/O panel, there is one USB 3.0 header on this motherboard. This USB 3.0 header can support two USB 3.0 ports.

Infrared Module Header

(5-pin IR1)

(see p.2, No. 19)

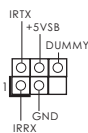

This header supports an optional wireless transmitting and receiving infrared module.

Consumer Infrared Module Header

(4-pin CIR1)

(see p.2, No. 26)



This header can be used to connect the remote controller receiver.

Front Panel Audio Header

(9-pin HD_AUDIO1)
(see p.2, No. 33)

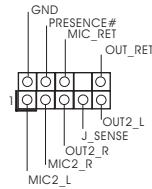

This is an interface for front panel audio cable that allows convenient connection and control of audio devices.



1. High Definition Audio supports Jack Sensing, but the panel wire on the chassis must support HDA to function correctly. Please follow the instruction in our manual and chassis manual to install your system.
2. If you use AC'97 audio panel, please install it to the front panel audio header as below:
 - A. Connect Mic_IN (MIC) to MIC2_L.
 - B. Connect Audio_R (RIN) to OUT2_R and Audio_L (LIN) to OUT2_L.
 - C. Connect Ground (GND) to Ground (GND).
 - D. MIC_RET and OUT_RET are for HD audio panel only. You don't need to connect them for AC'97 audio panel.
 - E. To activate the front mic.
For Windows® XP / XP 64-bit OS:
Select "Mixer". Select "Recorder". Then click "FrontMic".
For Windows® 7 / 7 64-bit / Vista™ / Vista™ 64-bit OS:
Go to the "FrontMic" Tab in the Realtek Control panel. Adjust "Recording Volume".

System Panel Header

(9-pin PANEL1)
(see p.2, No. 18)

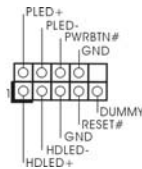

This header accommodates several system front panel functions.



Connect the power switch, reset switch and system status indicator on the chassis to this header according to the pin assignments below. Note the positive and negative pins before connecting the cables.

PWRBTN (Power Switch):

Connect to the power switch on the chassis front panel. You may configure the way to turn off your system using the power switch.

RESET (Reset Switch):

Connect to the reset switch on the chassis front panel. Press the reset switch to restart the computer if the computer freezes and fails to perform a normal restart.

English

PLED (System Power LED):

Connect to the power status indicator on the chassis front panel. The LED is on when the system is operating. The LED keeps blinking when the system is in S1/S3 sleep state. The LED is off when the system is in S4 sleep state or powered off (S5).

HDLED (Hard Drive Activity LED):

Connect to the hard drive activity LED on the chassis front panel. The LED is on when the hard drive is reading or writing data.

The front panel design may differ by chassis. A front panel module mainly consists of power switch, reset switch, power LED, hard drive activity LED, speaker and etc. When connecting your chassis front panel module to this header, make sure the wire assignments and the pin assignments are matched correctly.

Chassis Speaker Header

(4-pin SPEAKER 1)
(see p.2, No. 16)

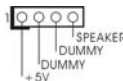

Please connect the chassis speaker to this header.

Power LED Header

(3-pin PLED1)
(see p.2, No. 17)



Please connect the chassis power LED to this header to indicate system power status. The LED is on when the system is operating. The LED keeps blinking in S1/S3 state. The LED is off in S4 state or S5 state (power off).

Chassis and Power Fan Connectors

(4-pin CHA_FAN1)
(see p.2, No. 22)

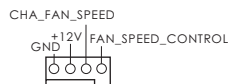

(3-pin CHA_FAN2)
(see p.2, No. 35)

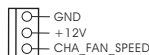

(3-pin PWR_FAN1)
(see p.2, No. 2)

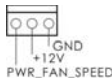

Please connect the fan cables to the fan connectors and match the black wire to the ground pin. CHA_FAN1 and CHA_FAN2 supports Fan Control.

CPU Fan Connectors

(4-pin CPU_FAN1)
(see p.2, No. 3)

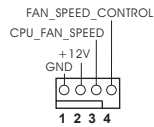

Please connect the CPU fan cable to the connector and match the black wire to the ground pin.



Though this motherboard provides 4-Pin CPU fan (Quiet Fan) support, the 3-Pin CPU fan still can work successfully even without the fan speed control function. If you plan to connect the 3-Pin CPU fan to the CPU fan connector on this motherboard, please connect it to Pin 1-3.

Pin 1-3 Connected
3-Pin Fan Installation



(3-pin CPU_FAN2)
(see p.2, No. 1)

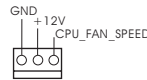

ATX Power Connector

(24-pin ATXPWR1)
(see p.2, No. 8)

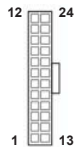

Please connect an ATX power supply to this connector.



Though this motherboard provides 24-pin ATX power connector, it can still work if you adopt a traditional 20-pin ATX power supply. To use the 20-pin ATX power supply, please plug your power supply along with Pin 1 and Pin 13.

20-Pin ATX Power Supply Installation

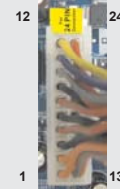

ATX 12V Power Connector

(8-pin ATX12V1)
(see p.2, No. 4)



Please connect an ATX 12V power supply to this connector.



Though this motherboard provides 8-pin ATX 12V power connector, it can still work if you adopt a traditional 4-pin ATX 12V power supply. To use the 4-pin ATX power supply, please plug your power supply along with Pin 1 and Pin 5.

4-Pin ATX 12V Power Supply Installation



English

Serial port Header
(9-pin COM1)
(see p.2, No. 27)

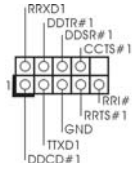

This COM1 header supports a serial port module.

HDMI_SPDIF Header
(2-pin HDMI_SPDIF1)
(see p.2, No. 34)



HDMI_SPDIF header, providing SPDIF audio output to HDMI VGA card, allows the system to connect HDMI Digital TV/ projector/LCD devices. Please connect the HDMI_SPDIF connector of HDMI VGA card to this header.

2.12 Driver Installation Guide

To install the drivers to your system, please insert the support CD to your optical drive first. Then, the drivers compatible to your system can be auto-detected and listed on the support CD driver page. Please follow the order from top to bottom to install those required drivers. Therefore, the drivers you install can work properly.

2.13 Installing Windows® 7 / 7 64-bit / Vista™ / Vista™ 64-bit With RAID Functions

If you want to install Windows® 7 / 7 64-bit / Vista™ / Vista™ 64-bit on your SATA / SATA2 / SATA3 HDDs with RAID functions, please refer to the document at the following path in the Support CD for detailed procedures:

..\ RAID Installation Guide

2.14 Installing Windows® 7 / 7 64-bit / Vista™ / Vista™ 64-bit / XP / XP 64-bit Without RAID Functions

If you want to install Windows® 7 / 7 64-bit / Vista™ / Vista™ 64-bit / XP / XP 64-bit OS on your SATA / SATA2 / SATA3 HDDs without RAID functions, please follow the procedures below according to the OS you install.

2.14.1 Installing Windows® XP / XP 64-bit Without RAID Functions

If you want to install Windows® XP / XP 64-bit OS on your SATA / SATA2 / SATA3 HDDs without RAID functions, please follow the steps below.



AHCI mode is not supported under Windows® XP / XP 64-bit.

Using SATA / SATA2 / SATA3 HDDs without NCQ function

STEP 1: Set Up UEFI.

- A. Enter UEFI SETUP UTILITY → Advanced screen → Storage Configuration.
- B. Set the option "SATA Mode Selection" to [IDE]. (For SATA2_2 to SATA2_5, SATA3_0 and SATA3_1 ports.)
Set the option "ASMedia SATA3 Mode" to [IDE]. (For SATA3_A0 and SATA3_A1 ports.)

STEP 2: Install Windows® XP / XP 64-bit OS on your system.

2.14.2 Installing Windows® 7 / 7 64-bit / Vista™ / Vista™ 64-bit Without RAID Functions

If you want to install Windows® 7 / 7 64-bit / Vista™ / Vista™ 64-bit OS on your SATA / SATA2 / SATA3 HDDs without RAID functions, please follow the steps below.

Using SATA / SATA2 / SATA3 HDDs without NCQ function

STEP 1: Set Up UEFI.

- A. Enter UEFI SETUP UTILITY → Advanced screen → Storage Configuration.
- B. Set the option “SATA Mode Selection” to [IDE]. (For SATA2_2 to SATA2_5, SATA3_0 and SATA3_1 ports.)
Set the option “ASMedia SATA3 Mode” to [IDE]. (For SATA3_A0 and SATA3_A1 ports.)

STEP 2: Install Windows® 7 / 7 64-bit / Vista™ / Vista™ 64-bit OS on your system.

Using SATA / SATA2 / SATA3 HDDs with NCQ function

STEP 1: Set Up UEFI.

- A. Enter UEFI SETUP UTILITY → Advanced screen → Storage Configuration.
- B. Set the option “SATA Mode Selection” to [AHCI]. (For SATA2_2 to SATA2_5, SATA3_0 and SATA3_1 ports.)
Set the option “ASMedia SATA3 Mode” to [AHCI]. (For SATA3_A0 and SATA3_A1 ports.)

STEP 2: Install Windows® 7 / 7 64-bit / Vista™ / Vista™ 64-bit OS on your system.

3. BIOS Information

The Flash Memory on the motherboard stores BIOS Setup Utility. When you start up the computer, please press <F2> or during the Power-On-Self-Test (POST) to enter BIOS Setup utility; otherwise, POST continues with its test routines. If you wish to enter BIOS Setup after POST, please restart the system by pressing <Ctl> + <Alt> + <Delete>, or pressing the reset button on the system chassis. The BIOS Setup program is designed to be user-friendly. It is a menu-driven program, which allows you to scroll through its various sub-menus and to select among the predetermined choices. For the detailed information about BIOS Setup, please refer to the User Manual (PDF file) contained in the Support CD.

4. Software Support CD information

This motherboard supports various Microsoft® Windows® operating systems: 7 / 7 64-bit / Vista™ / Vista™ 64-bit / XP / XP 64-bit. The Support CD that came with the motherboard contains necessary drivers and useful utilities that will enhance motherboard features. To begin using the Support CD, insert the CD into your CD-ROM drive. It will display the Main Menu automatically if "AUTORUN" is enabled in your computer. If the Main Menu does not appear automatically, locate and double-click on the file "ASSETUP.EXE" from the BIN folder in the Support CD to display the menus.

1. Einführung

Wir danken Ihnen für den Kauf des ASRock **Z77 Pro4-M** Motherboard, ein zuverlässiges Produkt, welches unter den ständigen, strengen Qualitätskontrollen von ASRock gefertigt wurde. Es bietet Ihnen exzellente Leistung und robustes Design, gemäß der Verpflichtung von ASRock zu Qualität und Halbarkeit. Diese Schnellinstallationsanleitung führt in das Motherboard und die schrittweise Installation ein. Details über das Motherboard finden Sie in der Bedienungsanleitung auf der Support-CD.



Da sich Motherboard-Spezifikationen und BIOS-Software verändern können, kann der Inhalt dieses Handbuchs ebenfalls jederzeit geändert werden. Für den Fall, dass sich Änderungen an diesem Handbuch ergeben, wird eine neue Version auf der ASRock-Website, ohne weitere Ankündigung, verfügbar sein. Die neuesten Grafikkarten und unterstützten CPUs sind auch auf der ASRock-Website aufgelistet.

ASRock-Website: <http://www.asrock.com>

Wenn Sie technische Unterstützung zu Ihrem Motherboard oder spezifische Informationen zu Ihrem Modell benötigen, besuchen Sie bitte unsere Webseite: www.asrock.com/support/index.asp

1.1 Kartoninhalt

ASRock **Z77 Pro4-M** Motherboard

(Micro ATX-Formfaktor: 24.4 cm x 24.4 cm; 9.6 Zoll x 9.6 Zoll)

ASRock **Z77 Pro4-M** Schnellinstallationsanleitung

ASRock **Z77 Pro4-M** Support-CD

Zwei Serial ATA (SATA) -Datenkabel (optional)

Ein I/O Shield



ASRock erinnert...

Zur besseren Leistung unter Windows® 7 / 7, 64 Bit / Vista™ / Vista™ 64 Bit empfehlen wir, die Speicherkonfiguration im BIOS auf den AHCI-Modus einzustellen. Hinweise zu den BIOS-Einstellungen finden Sie in der Bedienungsanleitung auf der mitgelieferten CD.

1.2 Spezifikationen

Plattform	<ul style="list-style-type: none"> - Micro ATX-Formfaktor: 24.4 cm x 24.4 cm; 9.6 Zoll x 9.6 Zoll - Alle Feste Kondensatordesign (100 % hochwertige japanische Fertigung leitfähiger Polymerkondensatoren)
CPU	<ul style="list-style-type: none"> - Unterstützt Intel® Core™ i7- / i5- / i3-Prozessoren der 3ten und 2ten Generation im LGA1155-Package - Digi Power-Design - 4 + 2-Stromphasendesign - Unterstützt Intel® Turbo Boost 2.0-Technologie - Unterstützt freigegebene CPU der K-Serie - Unterstützt Hyper-Threading-Technologie (siehe VORSICHT 1) - Unterstützt Intel® Rapid Start Technology und Smart Connect Technology mit Intel® Ivy Bridge-Prozessor
Chipsatz	<ul style="list-style-type: none"> - Intel® Z77
Speicher	<ul style="list-style-type: none"> - Dual-Kanal DDR3 Speichertechnologie (siehe VORSICHT 2) - 4 x Steckplätze für DDR3 - Unterstützt DDR3 2800+(OC)/2400(OC)/2133(OC)/1866(OC)/1600/1333/1066 non-ECC, ungepufferter Speicher - Max. Kapazität des Systemspeichers: 32GB (siehe VORSICHT 3) - Unterstützt Intel® Extreme Memory Profile (XMP)1.3/1.2
Erweiterungssteckplätze	<ul style="list-style-type: none"> - 1 x PCI Express 3.0 x16-Steckplätze (PCI E1: x16-Modus) (siehe VORSICHT 4) * PCI E 3.0 wird nur mit Intel® Ivy Bridge-Prozessor unterstützt. Mit Intel® Sandy Bridge-Prozessor wird nur PCI E 2.0 unterstützt. - 2 x PCI Express 2.0 x16-Steckplätze (PCI E3: x1-Modus; PCI E4: x4-Modus) - 1 x PCI Express 2.0 x1-Steckplätze - Unterstützt AMD™ Quad CrossFireX™ und CrossFireX™
Onboard-VGA	<ul style="list-style-type: none"> * Integrierte Intel® HD-Grafikdarstellungen und die VGA-Ausgänge können nur durch GPU-integrierte Prozessoren unterstützt werden. - Unterstützt hochauflösende integrierte Intel®-Grafiklösungen: Intel® Quick-Sync-Video 2.0, Intel® InTru™ 3D, Intel® Clear-Video-Technik (HD), Intel® Insider™, Intel® HD Graphics 2500/4000 - Pixel Shader 5.0, DirectX 11 mit Intel® Ivy Bridge-Prozessor, Pixel Shader 4.1, DirectX 10.1 mit Intel® Sandy Bridge-

	<p>Prozessor</p> <ul style="list-style-type: none"> - Maximal gemeinsam genutzter Speicher 1760MB (siehe VORSICHT 5) - Drei VGA-Ausgangsoptionen: D-Sub, DVI-D sowie HDMI (siehe VORSICHT 6) - Unterstützt HDMI 1.4a mit einer maximalen Auflösung von 1920 x 1200 bei 60 Hz - Unterstützt DVI mit einer maximalen Auflösung von 1920 x 1200 bei 60 Hz - Unterstützt D-Sub mit einer maximalen Auflösung von 2048 x 1536 bei 75 Hz - Unterstützt Auto Lip Sync, Deep Color (12bpc), xvYCC und HBR (High Bit Rate-Audio) mit HDMI (kompatibler HDMI-Bildschirm erforderlich) (siehe VORSICHT 7) - Unterstützt HDCP-Funktion mit DVI- und HDMI-Ports - Unterstützt 1080p Blu-ray (BD) / HD-DVD-Wiedergabe mit DVI- und HDMI-Ports
Audio	<ul style="list-style-type: none"> - 7.1 CH HD Audio mit dem Inhalt Schutz (Realtek ALC892 Audio Codec) - Premium Blu-ray-Audio-Unterstützung - Unterstützt THX TruStudio™
LAN	<ul style="list-style-type: none"> - PCIE x1 Gigabit LAN 10/100/1000 Mb/s - Realtek RTL8111E - Unterstützt Wake-On-LAN - Unterstützt LAN-Kabelerkennung - Unterstützt energieeffizientes Ethernet 802.3az - Unterstützt PXE
E/A-Anschlüsse an der Rückseite	<p>I/O Panel</p> <ul style="list-style-type: none"> - 1 x PS/2-Tastaturanschluss - 1 x D-Sub port - 1 x DVI-D port - 1 x HDMI port - 1 x optischer SPDIF-Ausgang - 4 x Standard-USB 2.0-Anschlüsse - 1 x eSATA3-Anschluss - 2 x Standard-USB 3.0-Anschlüsse - 1 x RJ-45 LAN Port mit LED (ACT/LINK LED und SPEED LED) - HD Audiobuchse: Lautsprecher hinten / Mitte / Bass / Audioeingang / Lautsprecher vorne / Mikrofon (siehe VORSICHT 8)

SATA3	<ul style="list-style-type: none"> - 2 x SATA 3-Anschlüsse (6,0 Gb/s) durch Intel® Z77; unterstützt RAID- (RAID 0, RAID 1, RAID 5, RAID 10, Intel Rapid Storage und Intel Smart Response-Technologie), NCQ-, AHCI- und Hot Plug Funktionen - 2 x SATA 3-Anschlüsse (6,0 Gb/s) durch ASMedia ASM1061, unterstützt NCQ-, AHCI- und Hot Plug Funktionen (SATA3_A1-Anschluss wird mit dem eSATA3-Port geteilt)
USB3.0	<ul style="list-style-type: none"> - 2 x USB 3.0-Ports an der Rückseite, unterstützt USB 1.0/2.0/3.0 mit bis zu 5 Gb/s - 1 x USB 3.0-Header (unterstützt zwei USB 3.0-Ports) an der Vorderseite, unterstützt USB 1.0/2.0/3.0 mit bis zu 5 Gb/s
Anschlüsse	<ul style="list-style-type: none"> - 4 x SATA2 3,0 GB/s-Anschlüsse, unterstützen RAID- (RAID 0, RAID 1, RAID 5, RAID 10, Intel Rapid Storage und Intel Smart Response-Technologie), NCQ-, AHCI- und Hot Plug Funktionen - 4 x SATA3 6,0 GB/s-Anschlüsse - 1 x Infrarot-Modul-Header - 1 x Consumer Infrared-Modul-Header - 1 x Druckerport-Anschlussleiste - 1 x COM-Anschluss-Header - 1 x HDMI_SPDIF-Anschluss - 1 x Betriebs-LED-Header - CPU/Gehäuse/Strom Lüfter-Anschluss - 24-pin ATX-Netz-Header - 8-pin anschluss für 12V-ATX-Netzteil - Anschluss für Audio auf der Gehäusevorderseite - 3 x USB 2.0-Anschlüsse (Unterstützung 6 zusätzlicher USB 2.0-Anschlüsse) - 1 x USB 3.0-Anschlüsse (Unterstützung 2 zusätzlicher USB 3.0-Anschlüsse)
BIOS	<ul style="list-style-type: none"> - 64Mb AMIs Legal BIOS UEFI mit GUI-Unterstützung - Unterstützung für "Plug and Play" - ACPI 1.1-Weckfunktionen - JumperFree-Modus - SMBIOS 2.3.1 - CPU Core, IGPU, DRAM, 1.8V PLL, VTT, VCCSA Stromspannung Multianpassung
CD d'assistance	<ul style="list-style-type: none"> - Treiber, Dienstprogramme, Antivirussoftware (Probeversion), CyberLink MediaEspresso 6.5-Testversion, ASRock MAGIX-Multimedia-Suite - OEM
Einzigartige Eigenschaft	<ul style="list-style-type: none"> - ASRock Extreme Tuning Utility (AXTU) (siehe VORSICHT 9) - ASRock Sofortstart

	<ul style="list-style-type: none"> - ASRock Instant Flash (siehe VORSICHT 10) - ASRock APP Charger (siehe VORSICHT 11) - ASRock SmartView (siehe VORSICHT 12) - ASRock XFast USB (siehe VORSICHT 13) - ASRock XFast LAN (siehe VORSICHT 14) - ASRock XFast RAM (siehe VORSICHT 15) - ASRock Crashless BIOS (siehe VORSICHT 16) - ASRock OMG (Online Management Guard) (siehe VORSICHT 17) - Lucid Virtu Universal MVP (siehe VORSICHT 18) * Lucid Virtu Universal MVP kann nur durch GPU-integrierte Prozessoren unterstützt werden. - ASRock ein/aus-Wiedergabetechnologie (siehe VORSICHT 19) - Hybrid Booster: <ul style="list-style-type: none"> - Schrittlöser CPU-Frequenz-Kontrolle (siehe VORSICHT 20) - ASRock U-COP (siehe VORSICHT 21) - Boot Failure Guard (B.F.G. – Systemstartfehlerschutz) - Combo-Kühloption (siehe VORSICHT 22) - Gute Nacht-LED
Hardware Monitor	<ul style="list-style-type: none"> - Überwachung der CPU-Temperatur - Motherboardtemperaturerkennung - Drehzahlmessung für CPU/Gehäuse/Strom Lüfter - Geräuscharmer CPU-/Gehäuselüfter (ermöglicht die automatische Anpassung der Gehäuselüftergeschwindigkeit durch CPU-Temperatur) - Mehrstufige Geschwindigkeitssteuerung für CPU/Gehäuse Lüfter - Spannungsüberwachung: +12V, +5V, +3.3V, Vcore
Betriebssysteme	<ul style="list-style-type: none"> - Unterstützt Microsoft® Windows® 7 / 7 64-Bit / Vista™ / Vista™ 64-Bit / XP / XP 64-Bit (siehe VORSICHT 23)
Zertifizierungen	<ul style="list-style-type: none"> - FCC, CE, WHQL - Gemäß Ökodesign-Richtlinie (ErP/EuP) (Stromversorgung gemäß Ökodesign-Richtlinie (ErP/EuP) erforderlich) (siehe VORSICHT 24)

* Für die ausführliche Produktinformation, besuchen Sie bitte unsere Website:
<http://www.asrock.com>

WARNUNG

Beachten Sie bitte, dass Overclocking, einschließlich der Einstellung im BIOS, Anwenden der Untied Overclocking-Technologie oder Verwenden von Overclocking-Werkzeugen von Dritten, mit einem gewissen Risiko behaftet ist. Overclocking kann sich nachteilig auf die Stabilität Ihres Systems auswirken oder sogar Komponenten und Geräte Ihres Systems beschädigen. Es geschieht dann auf eigene Gefahr und auf Ihre Kosten. Wir übernehmen keine Verantwortung für mögliche Schäden, die aufgrund von Overclocking verursacht wurden.

VORSICHT!

1. Die Einstellung der "Hyper-Threading Technology", finden Sie auf Seite 52 des auf der Support-CD enthaltenen Benutzerhandbuches beschrieben.
2. Dieses Motherboard unterstützt Dual-Kanal-Speichertechnologie. Vor Implementierung der Dual-Kanal-Speichertechnologie müssen Sie die Installationsanleitung für die Speichermodule auf Seite 17 zwecks richtiger Installation gelesen haben.
3. Durch Betriebssystem-Einschränkungen kann die tatsächliche Speichergröße weniger als 4 GB betragen, da unter Windows® 7 / Vista™ / XP etwas Speicher zur Nutzung durch das System reserviert wird. Unter Windows® OS mit 64-Bit-CPU besteht diese Einschränkung nicht. Sie können ASRock XFast RAM zur Nutzung des Speichers, den Windows® nicht verwenden kann, einsetzen.
4. Unterstützt nur der PCIe1-Steckplatz Geschwindigkeiten der 3ten Generation. Damit Sie PCI Express mit der Geschwindigkeit der 3ten Generation nutzen können, müssen Sie einen Ivy Bridge-Prozessor installieren. Wenn Sie einen Sandy Bridge-Prozessor installieren, läuft PCI Express nur bei der Geschwindigkeit der 2ten Generation.
5. Die Maximalspeichergröße ist von den Chipshändler definiert und umgetauscht. Bitte überprüfen Sie Intel® website für die neuliche Information.
6. Sie können nur die Nutzung von zwei von drei Bildschirmen auswählen. Die D-Sub-, DVI-D- und HDMI-Bildschirme können nicht gleichzeitig aktiviert werden. Zudem kann der DVI-D-Port mit DVI-zu-HDMI-Adapter dieselben Funktionen wie der HDMI-Port unterstützen.
7. xvYCC und Deep Color werden nur unter Windows® 7 64-Bit / 7 unterstützt. Der Deep Color-Modus wird nur aktiviert, wenn der Bildschirm 12bpc in EDID unterstützt. HBR wird unter Windows® 7 64 Bit / 7 / Vista™ 64 Bit / Vista™ unterstützt.
8. Der Mikrofoneingang dieses Motherboards unterstützt Stereo- und Mono-Modi. Der Audioausgang dieses Motherboards unterstützt 2-Kanal-, 4-Kanal-, 6-Kanal- und 8-Kanal-Modi. Stellen Sie die richtige Verbindung anhand der Tabelle auf Seite 3 her.
9. ASRock Extreme Tuning Utility (AXTU) ist ein Alles-in-einem-Werkzeug zur Feineinstellung verschiedener Systemfunktionen an einer benutzerfreundlichen Schnittstelle; diese beinhaltet Hardware-

Überwachung, Lüftersteuerung, Übertaktung, OC DNA und IES. Über die Hardware-Überwachung können Sie die Hauptsystemdaten einsehen. Die Lüftersteuerung zeigt Ihnen zur Anpassung Lüftergeschwindigkeit und Temperatur an. Bei der Übertaktung können Sie die CPU-Frequenz zur Erzielung optimaler Systemleistung übertakten. OC DNA ermöglicht Ihnen die Speicherung Ihrer OC-Einstellungen als Profil, welches Sie mit Freunden teilen können. Ihre Freunde können das OC-Profil dann in ihrem System laden und so die gleichen OC-Einstellungen erzielen. Per IES (Intelligent Energy Saver) kann der Spannungsregulator bei Inaktivität der CPU-Kerne die Anzahl an Ausgangsphasen zur Steigerung der Effizienz reduzieren – ohne die Rechenleistung zu beeinträchtigen. Hinweise zur Bedienung der ASRock Extreme Tuning Utility (AXTU) finden Sie auf unserer Webseite.

ASRock-Webseite: <http://www.asrock.com>

10. ASRock Instant Flash ist ein im Flash-ROM eingebettetes BIOS-Flash-Programm. Mithilfe dieses praktischen BIOS-Aktualisierungswerkzeugs können Sie das System-BIOS aktualisieren, ohne dafür zuerst Betriebssysteme wie MS-DOS oder Windows® aufrufen zu müssen. Mit diesem Programm bekommen Sie durch Drücken der <F6>-Taste während des POST-Vorgangs oder durch Drücken der <F2>-Taste im BIOS-Setup-Menü Zugang zu ASRock Instant Flash. Sie brauchen dieses Werkzeug einfach nur zu starten und die neue BIOS-Datei auf Ihrem USB-Flash-Laufwerk, Diskettenlaufwerk oder der Festplatte zu speichern, und schon können Sie Ihr BIOS mit nur wenigen Klickvorgängen ohne Bereitstellung einer zusätzlichen Diskette oder eines anderen komplizierten Flash-Programms aktualisieren. Achten Sie darauf, dass das USB-Flash-Laufwerk oder die Festplatte das Dateisystem FAT32/16/12 benutzen muss.
11. Wenn Sie nach einer schnelleren, weniger eingeschränkten Möglichkeit zur Aufladung Ihrer Apple-Geräte (z. B. iPhone/iPad/iPod touch) suchen, bietet ASRock Ihnen eine wunderbare Lösung – den ASRock APP Charger. Installieren Sie einfach den ASRock APP Charger-Treiber; dadurch lädt sich Ihr iPhone wesentlich schneller über einen Computerauf – genaugenommen bis zu 40 % schneller als zuvor. Der ASRock APP Charger ermöglicht Ihnen die schnelle Aufladung mehrerer Apple-Geräte gleichzeitig; der Ladevorgang wird sogar dann fortgesetzt, wenn der PC den Ruhezustand (S1), Suspend to RAM-Modus (S3) oder Tiefschlafmodus (S4) aufruft oder ausgeschaltet wird (S5). Nach der Installation des APP Charger-Treibers können Sie im Handumdrehen das großartigste Ladeerlebnis überhaupt genießen.
ASRock-Webseite: <http://www.asrock.com/Feature/AppCharger/index.asp>
12. SmartView, eine neue Internetbrowserfunktion, ist eine intelligente IE-Startseite, die meist besuchte Internetseiten, Ihren Browserverlauf, Facebook-Freunde und Nachrichten in Echtzeit miteinander kombiniert: In einer speziellen Ansicht, die das Internet noch angenehmer und aufregender macht. ASRock-Motherboards werden exklusiv mit der Smart

View-Software geliefert, die auch dafür sorgt, dass Sie immer mit Ihren Freunden in Verbindung bleiben. Die SmartView-Funktionen können Sie mit den Windows®-Betriebssystemen 7 / 7, 64 Bit / Vista™ / Vista™ 64 Bit und dem Internet Explorer ab Version 8 nutzen.

ASRock-Website: <http://www.asrock.com/Feature/SmartView/index.asp>

13. ASRocks XFast USB dient der Steigerung der Leistungsfähigkeit Ihrer USB-Speichergeräte. Die Leistung kann je nach Eigenschaften des Gerätes variieren.
14. ASRock XFast LAN bietet einen schnelleren Internetzugang mit den nachfolgenden Vorteilen. LAN-Anwendungspriorisierung: Hiermit konfigurieren Sie auf ideale Weise Ihre Anwendungspriorität und/oder fügen neue Programme hinzu. Niedrigere Latenzzeit bei Spielen: Nach Einstellung einer höheren Online-Gamepriorität kann hiermit die Latenzzeit bei Spielen herabgesetzt werden. Datenverkehrsgestaltung: Sie können Youtube-Videos in HD anzeigen und gleichzeitig Dateien herunterladen. Echtzeitanalyse Ihrer Daten: Über das Statusfenster können Sie schnell ermitteln, welche Datenströme zur Zeit übertragen werden.
15. ASRock XFast RAM ist eine neue Funktion, die beim ASRock Extreme Tuning Utility (AXTU) integriert ist. Sie ermöglicht die vollständige Nutzung des Speicherplatzes, der unter Windows®-Betriebssystemen mit 32-Bit-CPU nicht verwendet werden kann. ASRock XFast RAM verkürzt die Ladezeit zuvor besuchter Webseiten, was das Surfen im Internet mehr denn je beschleunigt. Auch die Arbeit mit Adobe Photoshop erfolgt fünfmal schneller. Ein weiterer Vorteil von ASRock XFast RAM liegt in der Reduzierung der Häufigkeit des Zugriffs auf SSDs bzw. HDDs zur Verlängerung deren Lebenszeit.
16. ASRock Crashless BIOS ermöglicht Benutzern die Aktualisierung ihres BIOS, ohne dass diese Fehler fürchten müssen. Falls während der BIOS-Aktualisierung ein Stromausfall auftritt, setzt ASRock Crashless BIOS die BIOS-Aktualisierung automatisch fort, sobald die Stromversorgung wiederhergestellt ist. Bitte beachten Sie, dass alle BIOS-Dateien zuerst im Stammverzeichnis Ihres USB-Datenträgers platziert werden müssen. Diese Funktion wird nur von USB 2.0-Ports unterstützt.
17. Mit OMG können Administratoren den Internetzugang zu bestimmten Zeiten sperren oder einschränken. Sie können zwischen [Täglich], [Wochentag] und [Wochentage und Wochenende] auswählen, dann legen Sie die Anfangs- und Endzeiten fest, zu denen anderen Nutzern der Internetzugang gewährt werden soll. Damit OMG nicht von Nutzern umgangen werden kann, dürfen Gästekonten keine Rechte zur Änderung der Systemzeit eingeräumt werden.
18. Virtu Universal MVP beinhaltet die Basisfunktionen der Virtu Universal-Technologie, die integrierte GPU und separate GPU zur Erzielung optimaler Funktionalität virtualisiert. Verfügt zudem über Virtual Vsync™ für kompromisslose visuelle Qualität. Dank der zusätzlichen Vorzüge der HyperFormance-Technologie verbessert Virtu Universal MVP die Spielleistung durch intelligente Reduzierung redundanter Rendering-Aufgaben im Fluss zwischen CPU, GPU und Anzeigegerät.

19. Durch die ASRock ein/aus-Wiedergabetechnologie können Sie großartige Klangerlebnisse von portablen Audiogeräten, wie z. B. MP3-Playern oder Mobiltelefonen, an Ihrem PC genießen – selbst wenn der PC ausgeschaltet ist (oder sich im ACPI S5-Modus befindet)! Dieses Motherboard wird zudem mit einem kostenlosen Audiokabel (3,5 mm, Klinke) (optional) geliefert, was eine IT-Umgebung von höchster Benutzerfreundlichkeit gewährleistet.
20. Obwohl dieses Motherboard stufenlose Steuerung bietet, wird Overclocking nicht empfohlen. Frequenzen, die über den für den jeweiligen Prozessor vorgesehenen liegen, können das System instabil werden lassen oder die CPU beschädigen.
21. Wird eine Überhitzung der CPU registriert, führt das System einen automatischen Shutdown durch. Bevor Sie das System neu starten, prüfen Sie bitte, ob der CPU-Lüfter am Motherboard richtig funktioniert, und stecken Sie bitte den Stromkabelstecker aus und dann wieder ein. Um die Wärmeableitung zu verbessern, bitte nicht vergessen, etwas Wärmepaste zwischen CPU und Kühlkörper zu sprühen.
22. Die Combo-Kühleroption bietet die flexible Möglichkeit zur Aufnahme von drei verschiedenen CPU-Kühlertypen, Socket LGA 775, LGA 1155 und LGA 1156. Beachten Sie bitte, dass nicht alle 775 und 1156 CPU-Lüfter verwendet werden können.
23. ASRock XFast RAM wird von Microsoft® Windows® XP / XP 64 Bit nicht unterstützt. Intel® Smart Connect Technology und Intel® USB 3.0 ports wird von Microsoft® Windows® Vista™ / Vista™ 64-Bit / XP / XP 64-Bit nicht unterstützt.
24. EuP steht für Energy Using Product und kennzeichnet die Ökodesign-Richtlinie, die von der Europäischen Gemeinschaft zur Festlegung des Energieverbrauchs von vollständigen Systemen in Kraft gesetzt wurde. Gemäß dieser Ökodesign-Richtlinie (EuP) muss der gesamte Netzstromverbrauch von vollständigen Systemen unter 1,00 Watt liegen, wenn sie ausgeschaltet sind. Um dem EuP-Standard zu entsprechen, sind ein EuP-fähiges Motherboard und eine EuP-fähige Stromversorgung erforderlich. Gemäß einer Empfehlung von Intel muss eine EuP-fähige Stromversorgung dem Standard entsprechen, was bedeutet, dass bei einem Stromverbrauch von 100 mA die 5-Volt-Standby-Energieeffizienz höher als 50% sein sollte. Für die Wahl einer EuP-fähigen Stromversorgung empfehlen wir Ihnen, weitere Details beim Hersteller der Stromversorgung abzufragen.

1.3 Einstellung der Jumper

Die Abbildung verdeutlicht, wie Jumper gesetzt werden. Werden Pins durch Jumperkappen verdeckt, ist der Jumper "Gebrückt". Werden keine Pins durch Jumperkappen verdeckt, ist der Jumper "Offen". Die Abbildung zeigt einen 3-Pin Jumper dessen Pin1 und Pin2 "Gebrückt" sind, bzw. es befindet sich eine Jumper-Kappe auf diesen beiden Pins.

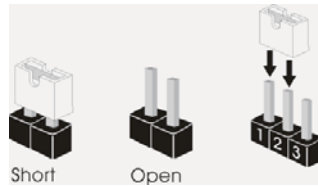

Jumper	Einstellung	Beschreibung
CMOS löschen (CLRCMOS1, 3-Pin jumper) (siehe S.2 - No. 15)	1_2 Default- Einstellung	2_3 CMOS löschen

Hinweis: CLRCMOS1 ermöglicht Ihnen die Löschung der Daten im CMOS. Zum Löschen und Zurücksetzen der Systemparameter auf die Standardeinrichtung schalten Sie den Computer bitte aus und trennen das Netzkabel von der Stromversorgung. Warten Sie 15 Sekunden, schließen Sie dann Pin2 und Pin3 am CLRCMOS1 über einen Jumper fünf Sekunden lang kurz. Sie sollten das CMOS allerdings nicht direkt nach der BIOS-Aktualisierung löschen. Wenn Sie das CMOS nach Abschluss der BIOS-Aktualisierung löschen müssen, fahren Sie zuerst das System hoch. Fahren Sie es dann vor der CMOS-Löschung herunter. Bitte beachten Sie, dass Kennwort, Datum, Uhrzeit, benutzerdefiniertes Profil, 1394 GUID und MAC-Adresse nur gelöscht werden, wenn die CMOS-Batterie entfernt wird.

1.4 Integrierte Header und Anschlüsse



Integrierte Header und Anschlüsse sind KEINE Jumper. Setzen Sie KEINE Jumperkappen auf diese Header und Anschlüsse. Wenn Sie Jumperkappen auf Header und Anschlüsse setzen, wird das Motherboard unreparierbar beschädigt!

Seriell-ATA2-Anschlüsse

(SATA2_2_3: siehe S.2 - No. 14)

(SATA2_4: siehe S.2 - No. 21)

(SATA2_5: siehe S.2 - No. 20)

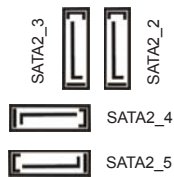

Diese vier Serial ATA2- (SATA2-)Verbinder unterstützten SATA-Datenkabel für interne Massenspeichergeräte. Die aktuelle SATA2- Schnittstelle ermöglicht eine Datenübertragungsrate bis 3,0 Gb/s.

Seriell-ATA3-Anschlüsse

(SATA3_A0_A1: siehe S.2 - No. 12)

(SATA3_0_1: siehe S.2 - No. 13)

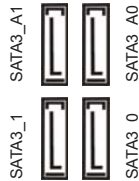

Diese vier Serial ATA3- (SATA3-)Verbinder unterstützten SATA-Datenkabel für interne Massenspeichergeräte. Die aktuelle SATA3- Schnittstelle ermöglicht eine Datenübertragungsrate bis 6,0 Gb/s. Falls der eSATA3-Port an der Rückblende verbunden wurde, funktioniert der interne SATA3_A1-Anschluss nicht.

Serial ATA- (SATA-)

Datenkabel

(Option)



Jedes Ende des SATA Datenkabels kann an die SATA / SATA2 / SATA3 Festplatte oder das SATA2 / SATA3 Verbindungsstück auf dieser Hauptplatine angeschlossen werden.

Druckerport-Anschlussleiste

(25-pol. LPT1)

(siehe S.2 - No. 28)

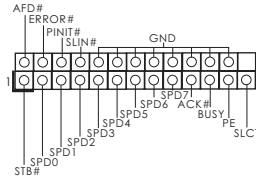

Dies ist eine Schnittstelle zum Anschluss eines Druckerport-Kabels, mit dem Sie passende Drucker auf einfache Weise anschließen können.

USB 2.0-Header

(9-pol. USB_6_7)

(siehe S.2 - No. 25)

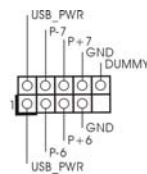

(9-pol. USB_8_9)

(siehe S.2 - No. 24)

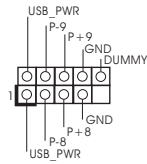

(9-pol. USB_10_11)

(siehe S.2 - No. 23)

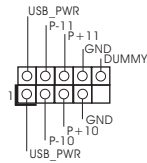

Zusätzlich zu den vier üblichen USB 2.0-Ports an den I/O-Anschlüssen befinden sich drei USB 2.0-Anschlussleisten am Motherboard. Pro USB 2.0-Anschlussleiste werden zwei USB 2.0-Ports unterstützt.

USB 3.0-Header

(19-pol. USB3_12_13)

(siehe S.2 - No. 9)

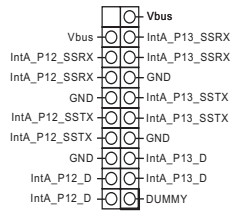

Neben zwei Standard-USB 3.0-Ports am E/A-Panel befindet sich ein USB 3.0-Header an diesem Motherboard. Dieser USB 3.0-Header kann zwei USB 3.0-Ports unterstützen.

Infrarot-Modul-Header

(5-pin IR1)

(siehe S.2 - No. 19)

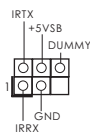

Dieser Header unterstützt ein optionales, drahtloses Send- und Empfangs-Infrarotmodul.

Deutsch

Consumer Infrared-Modul-Header

(4-pin CIR1)

(siehe S.2 - No. 26)



Dieser Header kann zum Anschließen Remote-Empfänger.

Anschluss für Audio auf der Gehäusevorderseite

(9-Pin HD_AUDIO1)

(siehe S.2 - No. 33)

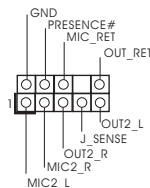

Dieses Interface zu einem Audio-Panel auf der Vorderseite Ihres Gehäuses, ermöglicht Ihnen eine bequeme Anschlussmöglichkeit und Kontrolle über Audio-Geräte.



1. High Definition Audio unterstützt Jack Sensing (automatische Erkennung falsch angeschlossener Geräte), wobei jedoch die Bildschirmverdrahtung am Gehäuse HDA unterstützen muss, um richtig zu funktionieren. Beachten Sie bei der Installation im System die Anweisungen in unserem Handbuch und im Gehäusehandbuch.
2. Wenn Sie die AC'97-Audiobleiste verwenden, installieren Sie diese wie nachstehend beschrieben an der Front-Audioanschlusssleiste:
 - A. Schließen Sie Mic_IN (MIC) an MIC2_L an.
 - B. Schließen Sie Audio_R (RIN) an OUT2_R und Audio_L (LIN) an OUT2_L an.
 - C. Schließen Sie Ground (GND) an Ground (GND) an.
 - D. MIC_RET und OUT_RET sind nur für den HD-Audioanschluss gedacht. Diese Anschlüsse müssen nicht an die AC'97-Audiobleiste angeschlossen werden.
 - E. So aktivieren Sie das Mikrofon an der Vorderseite.
 Bei den Betriebssystemen Windows® XP / XP 64 Bit:
 Wählen Sie „Mixer“. Wählen Sie „Recorder“ (Rekorder). Klicken Sie dann auf „FrontMic“ (Vorderes Mikrofon).
 Bei den Betriebssystemen Windows® 7 / 7 64 Bit / Vista™ / Vista™ 64 Bit:
 Wählen Sie im Realtek-Bedienfeld die „FrontMic“ (Vorderes Mikrofon)-Registerkarte. Passen Sie die „Recording Volume“ (Aufnahmelautstärke) an.

System Panel-Header

(9-pin PANEL1)

(siehe S.2 - No. 18)

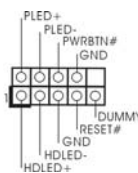

Dieser Header unterstützt mehrere Funktion der Systemvorderseite.



Schließen Sie die Ein-/Austaste, die Reset-Taste und die Systemstatusanzeige am Gehäuse an diesen Header an; befolgen Sie dabei die nachstehenden Hinweise zur Pinbelegung. Beachten Sie die positiven und negativen Pins, bevor Sie die Kabel anschließen.

PWRBTN (Ein-/Ausschalter):

Zum Anschließen des Ein-/Ausschalters an der Frontblende des Gehäuses. Sie können konfigurieren, wie das System mit Hilfe des Ein-/Ausschalters ausgeschaltet werden können soll.

RESET (Reset-Taste):

Zum Anschließen der Reset-Taste an der Frontblende des Gehäuses. Mit der Reset-Taste können Sie den Computer im Falle eines Absturzes neu starten.

PLED (Systembetriebs-LED):

Zum Anschließen der Betriebsstatusanzeige an der Frontblende des Gehäuses. Die LED leuchtet, wenn das System in Betrieb ist. Die LED blinkt, wenn sich das System im Ruhezustand S1/S3 befindet. Die LED schaltet sich aus, wenn sich das System in den Modi S4 befindet oder ausgeschaltet ist (S5).

HDLED (Festplattenaktivitäts-LED):

Zum Anschließen der Festplattenaktivitäts-LED an der Frontblende des Gehäuses. Die LED leuchtet, wenn die Festplatte Daten liest oder schreibt.

Das Design der Frontblende kann je nach Gehäuse variieren. Ein Frontblendenmodul besteht hauptsächlich aus einer Ein-/Austaste, einer Reset-Taste, einer Betriebs-LED, einer Festplattenaktivitäts-LED, Lautsprechern, etc. Stellen Sie beim Anschließen des Frontblendenmoduls Ihres Gehäuses an diesem Header sicher, dass die Kabel- und Pinbelegung korrekt übereinstimmen.

Gehäuselautsprecher-Header

(4-pin SPEAKER1)
(siehe S.2 - No. 16)

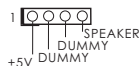

Schließen Sie den
Gehäuselautsprecher an
diesen Header an.

Betriebs-LED-Header
(3-pin PLED1)
(siehe S.2 - No. 17)



Bitte schließen Sie die Betriebs-LED des Gehäuses zur Anzeige des Systembetriebsstatus an diesem Header an. Die LED leuchtet, wenn das System in Betrieb ist. Die LED blinkt im S1/S3-Zustand. Im S4- oder S5-Zustand (ausgeschaltet) leuchtet die LED nicht.

Gehäuse und Strom Lüfteranschlüsse
(4-pin CHA_FAN1)
(siehe S.2, No. 22)

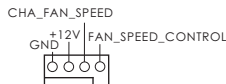

(3-pin CHA_FAN2)
(siehe S.2 - No. 35)

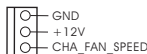

(3-pin PWR_FAN1)
(siehe S.2 - No. 2)

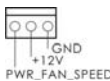

Verbinden Sie die Lüfterkabel mit den Lüfteranschlüssen, wobei der schwarze Draht an den Schutzleiterstift angeschlossen wird. CHA_FAN1- und CHA_FAN2- unterstützen Lüftersteuerung.

CPU-Lüfteranschluss
(4-pin CPU_FAN1)
(siehe S.2 - No. 3)

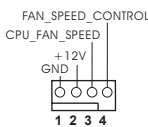

Verbinden Sie das CPU - Lüfterkabel mit diesem Anschluss und passen Sie den schwarzen Draht dem Erdungsstift an.



Obwohl dieses Motherboard einen vierpoligen CPU-Lüfteranschluss (Quiet Fan) bietet, können auch CPU-Lüfter mit dreipoligem Anschluss angeschlossen werden; auch ohne Geschwindigkeitsregulierung. Wenn Sie einen dreipoligen CPU-Lüfter an den CPU-Lüferanschluss dieses Motherboards anschließen möchten, verbinden Sie ihn bitte mit den Pins 1 – 3.

Pins 1–3 anschließen ←

Lüfter mit dreipoligem Anschluss installieren

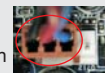

(3-pin CPU_FAN2)
(siehe S.2 - No. 1)

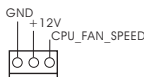

ATX-Netz-Header
(24-pin ATXPWR1)
(siehe S.2 - No. 8)

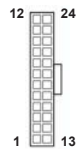

Verbinden Sie die ATX-Stromversorgung mit diesem Header.



Obwohl dieses Motherboard einen 24-pol. ATX-Stromanschluss bietet, kann es auch mit einem modifizierten traditionellen 20-pol. ATX-Netzteil verwendet werden. Um ein 20-pol. ATX-Netzteil zu verwenden, stecken Sie den Stecker mit Pin 1 und Pin 13 ein.

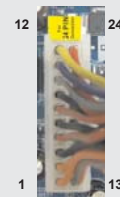

Installation eines 20-pol. ATX-Netzteils

ATX 12V Anschluss
(8-pin ATX12V1)
(siehe S.2 - No. 4)



Bitte schließen Sie an diesen Anschluss die ATX 12V Stromversorgung an.



Obwohl diese Hauptplatine 8-Pin ATX 12V Stromanschluss zur Verfügung stellt, kann sie noch arbeiten, wenn Sie einen traditionellen 4-Pin ATX 12V Energieversorgung adoptieren. Um die 4-Pin ATX Energieversorgung zu verwenden, stecken Sie bitte Ihre Energieversorgung zusammen mit dem Pin 1 und Pin 5 ein.



Installation der 4-Pin ATX 12V Energieversorgung

COM-Anschluss-Header
(9-pin COM1)
(siehe S.2 - No. 27)

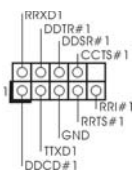

Dieser COM-Anschluss-Header wird verwendet, um ein COM-Anschlussmodul zu unterstützen.

HDMI_SPDIF-Anschluss

(2-pin HDMI_SPDIF1)

(siehe S.2 - No. 34)



Der HDMI_SPDIF-Anschluss stellt einen SPDIF-Audioausgang für eine HDMI-VGA-Karte zur Verfügung und ermöglicht den Anschluss von HDMI-Digitalgeräten wie Fernsehgeräten, Projektoren, LCD-Geräten an das System. Bitte verbinden Sie den HDMI_SPDIF-Anschluss der HDMI-VGA-Karte mit diesem Anschluss.

2. BIOS-Information

Das Flash Memory dieses Motherboards speichert das Setup-Utility. Drücken Sie <F2> oder während des POST (Power-On-Self-Test) um ins Setup zu gelangen, ansonsten werden die Testroutinen weiter abgearbeitet. Wenn Sie ins Setup gelangen wollen, nachdem der POST durchgeführt wurde, müssen Sie das System über die Tastenkombination <Ctrl> + <Alt> + <Delete> oder den Reset-Knopf auf der Gehäusevorderseite, neu starten. Natürlich können Sie einen Neustart auch durchführen, indem Sie das System kurz ab- und danach wieder anschalten.

Das Setup-Programm ist für eine bequeme Bedienung entwickelt worden. Es ist ein menügesteuertes Programm, in dem Sie durch unterschiedliche Untermenüs scrollen und die vorab festgelegten Optionen auswählen können. Für detaillierte Informationen zum BIOS-Setup, siehe bitte das Benutzerhandbuch (PDF Datei) auf der Support CD.

3. Software Support CD information

Dieses Motherboard unterstützt eine Reiche von Microsoft® Windows® Betriebssystemen: 7 / 7 64-Bit / Vista™ / Vista™ 64-Bit / XP / XP 64-Bit. Die Ihrem Motherboard beigefügte Support-CD enthält hilfreiche Software, Treiber und Hilfsprogramme, mit denen Sie die Funktionen Ihres Motherboards verbessern können. Legen Sie die Support-CD zunächst in Ihr CD-ROM-Laufwerk ein. Der Willkommensbildschirm mit den Installationsmenüs der CD wird automatisch aufgerufen, wenn Sie die "Autorun"-Funktion Ihres Systems aktiviert haben.

Erscheint der Willkommensbildschirm nicht, so "doppelklicken" Sie bitte auf das File ASSETUP.EXE im BIN-Verzeichnis der Support-CD, um die Menüs aufzurufen.

Das Setup-Programm soll es Ihnen so leicht wie möglich machen. Es ist menügesteuert, d.h. Sie können in den verschiedenen Untermenüs Ihre Auswahl treffen und die Programme werden dann automatisch installiert.

1. Introduction

Merci pour votre achat d'une carte mère ASRock **Z77 Pro4-M**, une carte mère très fiable produite selon les critères de qualité rigoureux de ASRock. Elle offre des performances excellentes et une conception robuste conformément à l'engagement d'ASRock sur la qualité et la fiabilité au long terme.

Ce Guide d'installation rapide présente la carte mère et constitue un guide d'installation pas à pas. Des informations plus détaillées concernant la carte mère pourront être trouvées dans le manuel l'utilisateur qui se trouve sur le CD d'assistance.



Les spécifications de la carte mère et le BIOS ayant pu être mis à jour, le contenu de ce manuel est sujet à des changements sans notification. Au cas où n'importe quelle modification intervenait sur ce manuel, la version mise à jour serait disponible sur le site web ASRock sans nouvel avis.

Vous trouverez les listes de prise en charge des cartes VGA et CPU également sur le site Web ASRock.

Site web ASRock, <http://www.asrock.com>

Si vous avez besoin de support technique en relation avec cette carte mère, veuillez consulter notre site Web pour de plus amples informations particulières au modèle que vous utilisez.

www.asrock.com/support/index.asp

1.1 Contenu du paquet

Carte mère ASRock **Z77 Pro4-M**

(Facteur de forme Micro ATX: 9.6 pouces x 9.6 pouces, 24.4 cm x 24.4 cm)

Guide d'installation rapide ASRock **Z77 Pro4-M**

CD de soutien ASRock **Z77 Pro4-M**

Deux câbles de données de série ATA (SATA) (en option)

Un I/O Panel Shield



ASRock vous rappelle...

Pour bénéficier des meilleures performances sous Windows® 7 / 7 64 bits / Vista™ / Vista™ 64 bits, il est recommandé de paramétrer l'option BIOS dans Configuration de stockage en mode AHCI. Pour plus de détails sur l'installation BIOS, référez-vous au "Mode d'emploi" sur votre CD de support.

1.2 Spécifications

Format	<ul style="list-style-type: none">- Facteur de forme Micro ATX: 9.6 pouces x 9.6 pouces, 24.4 cm x 24.4 cm- Conception à condensateur robuste (condensateurs polymère conducteur de qualité supérieure 100% fabriqués au Japon)
CPU	<ul style="list-style-type: none">- Prend en charge les processeurs Intel® Core™ i7 / i5 / i3 2ème et 3ème génération sur socket LGA1155- Conception Digi Power- 4 + 2 Power Phase conception- Prend en charge la technologie Intel® Turbo Boost 2.0- Prise en charge des unités centrales non verrouillées de série K- Prise en charge de la technologie Hyper-Threading (voir ATTENTION 1)- Prend en charge les technologies Intel® Rapid Start et Smart Connect avec processeur Intel® Ivy Bridge CPU
Chipsets	<ul style="list-style-type: none">- Intel® Z77
Mémoire	<ul style="list-style-type: none">- Compatible avec la Technologie de Mémoire à Canal Double (voir ATTENTION 2)- 4 x slots DIMM DDR3- Supporter DDR3 2800+(OC)/2400(OC)/2133(OC)/1866(OC) /1600/1333/1066 non-ECC, sans amortissement mémoire- Capacité maxi de mémoire système: 32GB (voir ATTENTION 3)- Prend en charge le profil de mémoire extrême Intel® (XMP) 1.3/1.2
Slot d'extension	<ul style="list-style-type: none">- 1 x slot PCI Express 3.0 x16 (PCIE1 : mode x16) (voir ATTENTION 4)* PCIE 3.0 n'est pris en charge qu'avec le processeur Intel® Ivy Bridge. Avec le processeur Intel® Sandy Bridge, seul PCIE 2.0 est pris en charge.- 2 x slots PCI Express 2.0 x16 (PCIE3 : mode x1; PCIE4 : mode x4)- 1 x slot PCI Express 2.0 x1- Prend en charge AMD Quad CrossFireX™ et CrossFireX™
VGA sur carte	<ul style="list-style-type: none">* Intel® HD Graphics avec visuels intégrés (Built-in Visuals) et les sorties VGA sont uniquement pris en charge par les processeurs à GPU intégré.- Supporte Intel® HD Graphics Built-in Visuals: Intel® Quick

	<p>Sync Video 2.0, Intel® InTru™ 3D, Intel® Clear Video HD Technology, Intel® Insider™, Intel® HD Graphics 2500/4000</p> <ul style="list-style-type: none"> - Pixel Shader 5.0, DirectX 11 avec CPU Intel® Ivy Bridge, Pixel Shader 4.1, DirectX 10.1 avec CPU Intel® Sandy Bridge - Mémoire partagée max 1760MB (voir ATTENTION 5) - Trois options de sortie VGA: D-Sub, DVI-D et HDMI (voir ATTENTION 6) - Prend en charge le HDMI 1.4a avec une résolution maximale jusqu'à 1920x1200 @ 60Hz - Prend en charge le DVI avec une résolution maximale jusqu'à 1920x1200 @ 60Hz - Prend en charge le D-Sub avec une résolution maximale jusqu'à 2048x1536 @ 75Hz - Prend en charge Lip Sync, Deep Color (12bpc), xvYCC et HBR (High Bit Rate Audio : Audio à haut débit binaire) avec HDMI (Moniteur compatible HDMI requis) (voir ATTENTION 7) - Prise en charge de la fonction HDCP avec ports DVI et HDMI - Supporter 1080p Blu-ray(BD)/ lecteur de HD-DVD avec ports DVI et HDMI
Audio	<ul style="list-style-type: none"> - 7,1 CH HD Audio avec protection de contenu (Realtek ALC892 Audio Codec) - Prise en charge de l'audio Premium Blu-ray - Prend en charge THX TruStudio™
LAN	<ul style="list-style-type: none"> - PCIE x1 Gigabit LAN 10/100/1000 Mb/s - Realtek RTL8111E - Support du Wake-On-LAN - Prise en charge de la détection de câble LAN - Prend en charge la norme Energy Efficient Ethernet (Ethernet à efficacité énergétique) 802.3az - Supporte PXE
Panneau arrière	<p>I/O Panel</p> <ul style="list-style-type: none"> - 1 x port clavier PS/2 - 1 x port D-Sub - 1 x port DVI-D - 1 x port HDMI - 1 x Port de sortie optique SPDIF - 4 x ports USB 2.0 par défaut - 1 x Connecteur eSATA3 - 2 x ports USB 3.0 par défaut

	<ul style="list-style-type: none"> - 1 x port LAN RJ-45 avec LED (ACT/LED CLIGNOTANTE et LED VITESSE) - Prise HD Audio: Haut-parleur arrière / Central /Basses / Entrée Ligne / Haut-parleur frontal / Microphone (voir ATTENTION 8)
SATA3	<ul style="list-style-type: none"> - 2 x connecteurs SATA3 6,0 Gb/s par Intel® Z77, prennent en charge les fonctions RAID (RAID 0, RAID 1, RAID 5, RAID 10, Intel Rapid Storage et Intel Smart Response), NCQ, AHCI et Hot Plug (Branchement à chaud) - 2 x connecteurs SATA3 6,0 Gb/s par ASMedia ASM1061, prennent en charge les fonctions NCQ, AHCI et Hot Plug (Branchement à chaud) (le connecteur SATA3_A1 est partagé avec le port eSATA3)
USB 3.0	<ul style="list-style-type: none"> - 2 x ports USB3.0 à l'arrière, prennent en charge USB 1.0/2.0/3.0 jusqu'à 5 Gb/s - 1 x barrette USB3.0 en façade (prend en charge 2 ports USB 3.0), prend en charge USB 1.0/2.0/3.0 jusqu'à 5 Gb/s
Connecteurs	<ul style="list-style-type: none"> - 4 x connecteurs SATA2, prennent en charge un taux de transfert de données pouvant aller jusqu'à 3.0Go/s, supporte RAID (RAID 0, RAID 1, RAID 5, RAID 10, Intel Rapid Storage et Intel Smart Response), NCQ, AHCI et Hot Plug (Branchement à chaud) - 4 x connecteurs SATA3, prennent en charge un taux de transfert de données pouvant aller jusqu'à 6.0Go/s - 1 x En-tête du module infrarouge - 1 x Barrette pour module à infrarouges grand public - 1 x embase de port d'impression - 1 x En-tête de port COM - 1 x Connecteur HDMI_SPDIF - 1 x Connecteur de LED d'alimentation - Connecteur pour ventilateur de CPU/Châssis/pouvoir Ventilateur - br. 24 connecteur d'alimentation ATX - br. 8 connecteur d'alimentation 12V ATX - Connecteur audio panneau avant - 3 x En-tête USB 2.0 (prendre en charge 6 ports USB 2.0 supplémentaires) - 1 x En-tête USB 3.0 (prendre en charge 2 ports USB 3.0 supplémentaires)
BIOS	<ul style="list-style-type: none"> - 64Mb AMI UEFI Legal BIOS avec support GUI - Support du "Plug and Play" - Compatible pour événements de réveil ACPI 1.1

	<ul style="list-style-type: none"> - Gestion jumperless - Support SMBIOS 2.3.1 - CPU Core, IGPU, DRAM, 1.8V PLL, VTT, VCCSA Tension Multi-ajustement
CD d'assistance	<ul style="list-style-type: none"> - Pilotes, utilitaires, logiciel anti-virus (version d'évaluation), CyberLink MediaEspresso 6.5 Trial, Suite multimédia ASRock MAGIX - OEM
Caractéristique unique	<ul style="list-style-type: none"> - Utilitaire ASRock Extreme Tuning (AXTU) (voir ATTENTION 9) - ASRock l'Instant Boot - ASRock Instant Flash (voir ATTENTION 10) - Chargeur ASRock APP (voir ATTENTION 11) - ASRock SmartView (voir ATTENTION 12) - ASRock XFast USB (voir ATTENTION 13) - ASRock XFast LAN (voir ATTENTION 14) - ASRock XFast RAM (voir ATTENTION 15) - ASRock Crashless BIOS (voir ATTENTION 16) - ASRock OMG (Online Management Guard) (see CAUTION 17) - Lucid Virtu Universal MVP (voir ATTENTION 18) * Lucid Virtu Universal MVP est uniquement pris en charge par les processeurs à GPU intégré. - Technologie Lecture Marche/Arrêt ASRock (voir ATTENTION 19) - L'accélérateur hybride: <ul style="list-style-type: none"> - Contrôle direct de la fréquence CPU (voir ATTENTION 20) - ASRock U-COP (voir ATTENTION 21) - Garde d'échec au démarrage (B.F.G.) - Combo Cooler Option (C.C.O.) (voir ATTENTION 22) - DEL veilleuse
Surveillance système	<ul style="list-style-type: none"> - Détection de la température de l'UC - Mesure de température de la carte mère - Tachéomètre ventilateur processeur/châssis/pouvoir ventilateur - Ventilateur silencieux pour unité centrale/châssis (permet le réglage automatique de la vitesse du ventilateur pour châssis, selon la température de l'unité centrale) - Commande de ventilateur CPU/Châssis à plusieurs vitesses - Monitoring de la tension: +12V, +5V, +3.3V, Vcore
OS	<ul style="list-style-type: none"> - Microsoft® Windows® 7 / 7 64-bit / Vista™ / Vista™ 64-bit

	/ XP / XP 64-bit (voir ATTENTION 23)
Certifications	- FCC, CE, WHQL - Prêt pour ErP/EuP (alimentation Prêt pour ErP/EuP requise) (voir ATTENTION 24)

* Pour de plus amples informations sur les produits, s'il vous plaît visitez notre site web:
<http://www.asrock.com>

ATTENTION

Il est important que vous réalisiez qu'il y a un certain risque à effectuer l'overclocking, y compris ajuster les réglages du BIOS, appliquer la technologie Untied Overclocking, ou utiliser des outils de tiers pour l'overclocking. L'overclocking peut affecter la stabilité de votre système, ou même causer des dommages aux composants et dispositifs de votre système. Si vous le faites, c'est à vos frais et vos propres risques. Nous ne sommes pas responsables des dommages possibles causés par l'overclocking.

ATTENTION!

1. En ce qui concerne le paramétrage "Hyper-Threading Technology", veuillez consulter la page 52 du manuel de l'utilisateur sur le CD technique.
2. Cette carte mère supporte la Technologie de Mémoire à Canal Double. Avant d'intégrer la Technologie de Mémoire à Canal Double, assurez-vous de bien lire le guide d'installation des modules mémoire en page 17 pour réaliser une installation correcte.
3. Du fait des limites du système d'exploitation, la taille mémoire réelle réservée au système pourra être inférieure à 4 Go sous Windows® 7 / Vista™ / XP. Avec Windows® OS avec CPU 64 bits, il n'y a pas ce genre de limitation. Vous pouvez utiliser ASRock XFast RAM pour accéder à la mémoire que Windows® ne peut pas utiliser.
4. PCIE1 prend en charge une vitesse pouvant atteindre Gen 3. Pour pouvoir utiliser PCI Express en vitesse Gen 3, vous devez installer le processeur Ivy Bridge. Si vous installez le processeur Sandy Bridge, PCI Express ne fonctionnera qu'en vitesse PCI Express Gen 2.
5. La dimension maximum du mémoire partage est définie par le vendeur de jeu de puces et est sujet de changer. Veuillez vérifier la Intel® website pour les informations récentes SVP.
6. Vous pouvez choisir de n'utiliser que deux moniteurs sur trois. Les moniteurs D-Sub, DVI-D et HDMI ne peuvent pas être activés en même temps. En outre, avec l'adaptateur DVI-HDMI, le port DVI-D peut prendre en charge les mêmes fonctions que le port HDMI.
7. xvYCC et Deep Color ne sont pris en charge que sous Windows® 7 64-bit / 7. Le mode Deep Color ne sera activé que si le moniteur prend en charge 12bpc en EDID. HBR est pris en charge sous Windows® 7 64-bit / 7 / Vista™ 64-bit / Vista™.

Français

8. Pour l'entrée microphone, cette carte mère supporte les deux modes stéréo et mono. Pour la sortie audio, cette carte mère supporte les modes 2-canaux, 4-canaux, 6-canaux et 8-canaux. Veuillez vous référer au tableau en page 3 pour effectuer la bonne connexion.
9. ASRock Extreme Tuning Utility (AXTU) est un utilitaire tout-en-un qui permet de régler précisément différentes fonctions du système, via une interface facile à utiliser, incluant Moniteur de périphériques, Contrôle du ventilateur, Overclocking, OC DNA et IES. Dans Moniteur de périphériques, il affiche les valeurs principales de votre système. Dans Contrôle du ventilateur, il affiche la vitesse du ventilateur et la température, que vous pouvez ajuster. Dans Overclocking, vous pouvez overclocker la fréquence du CPU pour améliorer les performances du système. Dans OC DNA, vous pouvez enregistrer vos réglages OC dans un profil et les partager avec vos amis. Vos amis pourront alors installer le profil OC sur leur système pour utiliser les mêmes réglages OC. Dans IES (Intelligent Energy Saver – Fonction intelligente d'économie d'énergie), le contrôleur de la tension peut réduire le nombre de phases de sortie pour améliorer le fonctionnement lorsque les cores du CPU ne sont pas utilisées, sans diminuer les performances de l'ordinateur. Veuillez visiter notre site Web pour plus d'informations sur l'utilisation des fonctions de l'utilitaire ASRock Extreme Tuning Utility (AXTU).
Site Web de ASRock : <http://www.asrock.com>
10. O ASRock Instant Flash é um utilitário de flash do BIOS incorporado na memória Flash ROM. Esta prática ferramenta de actualização do BIOS permite-lhe actualizar o BIOS do sistema sem necessitar de entrar nos sistemas operativos, como o MS-DOS ou o Windows®. Com este utilitário, poderá premir a tecla <F6> durante o teste de arranque POST ou premir a tecla <F2> para exibir o menu de configuração do BIOS para aceder ao ASRock Instant Flash. Execute esta ferramenta para guardar o novo ficheiro de BIOS numa unidade flash USB, numa disquete ou num disco rígido, em seguida, poderá actualizar o BIOS com apenas alguns cliques sem ter de utilizar outra disquete ou outro complicado utilitário de flash. Note que a unidade flash USB ou a unidade de disco rígido devem utilizar o sistema de ficheiros FAT32/16/12.
11. Si vous désirez un moyen plus rapide et moins contraignant de recharger vos appareils Apple tels que iPhone/iPad/iPod Touch, ASRock a préparé pour vous la solution idéale - le chargeur ASRock APP. Il suffit d'installer le pilote du chargeur APP, et vous pourrez recharger rapidement votre iPhone à partir de votre ordinateur, jusqu'à 40% plus vite qu'avant. Le chargeur ASRock APP vous permet de charger rapidement et simultanément plusieurs appareils Apple, et le chargement continu est même pris en charge lorsque le PC passe en mode Veille (S1), Suspension à la RAM (S3), hibernation (S4) ou hors tension (S5). Lorsque le pilote du chargeur APP est installé, vous découvrez un mode de mise en charge tout à fait inédit.
Site web ASRock : <http://www.asrock.com/Feature/AppCharger/index.asp>



-
12. SmartView, une nouvelle fonction du navigateur Internet, est une page de démarrage intelligente de IE, comportant à la fois vos sites Internet les plus visités, votre historique, vos amis Facebook et l'actualité en temps réel, le tout sur une vue optimisée pour une expérience de l'Internet encore plus personnelle. Les cartes mères ASRock sont équipées en exclusivité de l'utilitaire SmartView, ce qui vous permet de garder le contact avec vos amis itinérants. Pour utiliser la fonction SmartView, veuillez vous assurer que votre version de système d'exploitation est Windows® 7 / 7 64 bits / Vista™ / Vista™ 64 bits, et que vous utilisez le navigateur IE8. Site Internet ASRock : <http://www.asrock.com/Feature/SmartView/index.asp>
 13. ASRock XFast USB permet d'améliorer les performances de votre périphérique de stockage USB. Les performances réelles dépendent des propriétés du périphérique.
 14. ASRock XFast LAN fournit un accès Internet plus rapide, avec les avantages suivants. Priorisation d'application LAN : Vous pouvez configurer votre priorité d'application idéalement et/ou ajouter des nouveaux programmes. Latence plus basse dans les jeux : Après avoir réglé la priorité de jeux en ligne plus haute, cela peut réduire la latence dans les jeux. Forme du trafic : Vous pouvez regarder des vidéos HD YouTube et télécharger simultanément des fichiers. Analyse en temps réel de vos données : Avec la fenêtre d'état, vous pouvez facilement reconnaître les flux de données que vous êtes en train de transférer.
 15. ASRock XFast RAM est une nouvelle fonction intégrée à l'utilitaire ASRock Extreme Tuning Utility (AXTU). Il utilise à sa pleine capacité l'espace mémoire que les processeurs du système d'exploitation Windows OS 32-bit ne peuvent pas utiliser. ASRock XFast RAM diminue le temps de chargement des sites Internet précédemment visités, rendant la navigation sur le web plus rapide que jamais. Il rend également l'utilisation de Adobe Photoshop 5 fois plus rapide. Un autre avantage indéniable de ASRock XFast RAM est qu'il réduit la fréquence d'accès à vos SSD ou HDD afin d'accroître leur durée de vie utile.
 16. ASRock Crashless BIOS permet aux utilisateurs de mettre à jour leur BIOS sans qu'ils aient à craindre un plantage ou une défaillance. Si l'alimentation venait à être coupée durant la mise à jour du BIOS, ASRock Crashless BIOS terminera automatiquement la mise à jour du BIOS une fois le courant rétabli. Veuillez noter que les fichiers BIOS doivent être placés dans le répertoire racine de votre disque USB. Seuls les ports USB2.0 sont compatibles avec cette fonction.
 17. Grâce à OMG, les administrateurs ont la possibilité de créer un couvre-feu Internet ou de limiter l'accès à Internet à des périodes spécifiques. Choisissez entre les options [Quotidien], [Jour de la semaine] ou [Jours de la semaine et week-ends], puis programmez l'heure de début et de fin de l'accès Internet accordé à d'autres utilisateurs. Afin d'éviter tout contournement du système OMG par les utilisateurs, des comptes invité sans autorisation d'accès à la modification de l'heure système sont requis.

18. VIRTU Universal MVP intègre toutes les fonctionnalités de base de la technologie Virtu Universal, qui virtualise GPU intégrée et GPU discrète pour des fonctionnalités optimales. Il est également doté de la fonction Virtual Vsync™ pour une qualité visuelle sans compromis. Ajoutez à cela les avantages de la technologie HyperFormance, et VIRTU Universal MVP vous permettra d'obtenir des performances de jeu inégalées en réduisant intelligemment les tâches redondantes du rendu lors du flux entre le CPU, le GPU de la carte graphique et l'écran.
19. La Technologie Lecture Marche/Arrêt ASRock permet aux utilisateurs d'expérier l'audio incroyable à partir d'appareils audio portables comme un lecteur MP3 ou un téléphone portable, sur votre PC, même lorsque le PC est éteint (ou en mode ACPI S5)! Cette carte mère fournit aussi un câble audio 3,5mm gratuit (optionnel) qui facilite beaucoup dans les environnements informatiques.
20. Même si cette carte mère offre un contrôle sans souci, il n'est pas recommandé d'y appliquer un over clocking. Des fréquences de bus CPU autres que celles recommandées risquent de rendre le système instable ou d'endommager le CPU et la carte mère.
21. Lorsqu'une surchauffe du CPU est détectée, le système s'arrête automatiquement. Avant de redémarrer le système, veuillez vérifier que le ventilateur d'UC sur la carte mère fonctionne correctement et débranchez le cordon d'alimentation, puis rebranchez-le. Pour améliorer la dissipation de la chaleur, n'oubliez pas de mettre de la pâte thermique entre le CPU et le dissipateur lors de l'installation du PC.
22. Le Combo Cooler Option (C.C.O.) offre un choix flexible pour adopter trois types différents de refroidisseurs de CPU, les sockets LGA 775, LGA 1155 et LGA 1156. Veuillez noter que tous les ventilateurs de CPU 775 et 1156 ne peuvent pas être utilisés.
23. ASRock XFast RAM n'est pas pris en charge par Microsoft® Windows® XP / XP 64-bit. Intel® Smart Connect et Intel® ports USB 3.0 n'est pas pris en charge par Microsoft® Windows® Vista™ / Vista™ 64-bit / XP / XP 64-bit.
24. EuP, qui signifie Energy Using Product (Produit Utilisant de l'Energie), est une disposition établie par l'Union Européenne pour définir la consommation de courant pour le système entier. Conformément à la norme EuP, le courant CA total du système entier doit être inférieur à 1 W en mode d'arrêt. Pour être conforme à la norme EuP, une carte mère EuP et une alimentation EuP sont requises. Selon les suggestions d'Intel®, l'alimentation électrique EuP doit correspondre à la norme, qui est que l'efficacité électrique de 5v en mode de veille doit être supérieure à 50% pour 100 mA de consommation de courant. Pour choisir une alimentation électrique conforme à la norme EuP, nous vous recommandons de consulter votre fournisseur de courant pour plus de détails.

1.3 Réglage des cavaliers

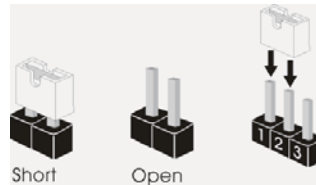
L'illustration explique le réglage des cavaliers. Quand un capuchon est placé sur les broches, le cavalier est « FERME ». Si aucun capuchon ne relie les broches, le cavalier est « OUVERT ». L'illustration montre un cavalier à 3 broches dont les broches 1 et 2 sont « FERMEES » quand le capuchon est placé sur ces 2 broches.



Le cavalier	Description	
Effacer la CMOS (CLRCMOS1) (voir p.2 fig. 15)	1_2  Paramètres par défaut	2_3  Effacer la CMOS

Remarque : CLRCMOS1 vous permet d'effacer les données du CMOS. Pour effacer et réinitialiser les paramètres du système à la configuration originale, veuillez éteindre l'ordinateur et débrancher le cordon d'alimentation de la prise de courant. Après 15 secondes, utilisez un couvercle de jumper pour court-circuiter les broches pin2 et pin3 de CLRCMOS1 pendant 5 secondes. Veuillez cependant ne pas effacer le CMOS immédiatement après avoir mis à jour le BIOS. Si vous avez besoin d'effacer le CMOS après avoir mis à jour le BIOS, vous devez allumer en premier le système, puis l'éteindre avant de continuer avec l'opération d'effacement du CMOS. Veuillez noter que le mot de passe, la date, l'heure, le profil par défaut de l'utilisateur, 1394 GUID et l'adresse MAC seront effacés seulement si la batterie du CMOS est enlevée.

1.4 En-têtes et Connecteurs sur Carte



Les en-têtes et connecteurs sur carte NE SONT PAS des cavaliers. NE PAS placer les capuchons de cavalier sur ces en-têtes et connecteurs. Le fait de placer les capuchons de cavalier sur les en-têtes et connecteurs causera à la carte mère des dommages irréversibles!

Connecteurs Série ATA2

(SATA2_2_3: voir p.2 No. 14)

(SATA2_4: voir p.2 No. 21)

(SATA2_5: voir p.2 No. 20)

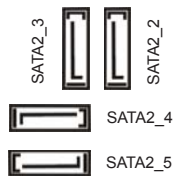

Ces quatre connecteurs Série ATA2 (SATA2) prennent en charge les câbles SATA pour les périphériques de stockage internes. L'interface SATA2 actuelle permet des taux transferts de données pouvant aller jusqu'à 3,0 Gb/s.

Connecteurs Série ATA3

(SATA3_A0_A1: voir p.2 No. 12)

(SATA3_0_1: voir p.2 No. 13)

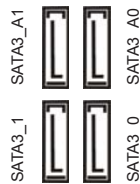

Ces quatre connecteurs Série ATA3 (SATA3) prennent en charge les câbles SATA pour les périphériques de stockage internes. L'interface SATA3 actuelle permet des taux transferts de données pouvant aller jusqu'à 6,0 Gb/s. Si le port eSATA3 sur le panneau E/S arrière est utilisé, le SATA3_A1 interne ne fonctionnera pas.

Câble de données
Série ATA (SATA)
(en option)



Toute cote du câble de data SATA peut être connecté au disque dur SATA / SATA2 / SATA3 ou au connecteur SATA2 / SATA3 sur la carte mère.

Embase de port d'impression

(LPT1 25 broches)
(voir p.2 No. 28)

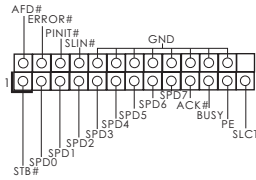

Il s'agit d'une interface pour le câble du port d'impression, qui permet le raccordement pratique de périphériques d'impression.

En-tête USB 2.0

(USB_6_7 br. 9)
(voir p.2 No. 25)

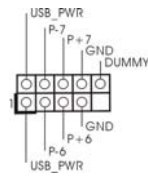

A côté des quatre ports USB 2.0 par défaut sur le panneau E/S, il y a trois embases USB 2.0 sur cette carte mère. Chaque embase USB 2.0 peut prendre en charge 2 ports USB 2.0.

(USB_8_9 br. 9)
(voir p.2 No. 24)

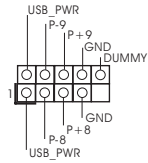

(USB_10_11 br. 9)
(voir p.2 No. 23)

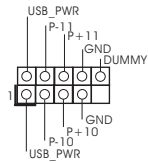

En-tête USB 3.0

(USB3_12_13 br. 19)
(voir p.2 No. 9)

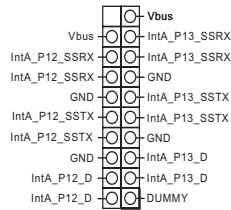

En plus des deux ports USB 3.0 par défaut sur le panneau E/S, il y a une barrette USB 3.0 sur la carte mère. Cette barrette USB 3.0 peut prendre en charge deux ports USB 3.0.

En-tête du module infrarouge

(IR1 br. 5)
(voir p.2 No. 19)

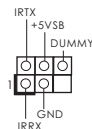

Cet en-tête supporte un module infrarouge optionnel de transfert et de réception sans fil.

Barrette pour module à infrarouges grand public
(CIR1 br.4)
(voir p.2 No. 26)



Cette barrette peut être utilisée pour connecter des récepteur.

Connecteur audio panneau
(HD_AUDIO1 br. 9)
(voir p.2 No. 33)

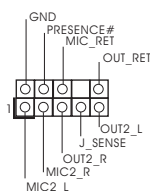

C'est une interface pour un câble avant audio en façade qui permet le branchement et le contrôle commodes de périphériques audio.



1. L'audio à haute définition (HDA) prend en charge la détection de fiche, mais le fil de panneau sur le châssis doit prendre en charge le HDA pour fonctionner correctement. Veuillez suivre les instructions dans notre manuel et le manuel de châssis afin d'installer votre système.
2. Si vous utilisez le panneau audio AC'97, installez-le sur l'adaptateur audio du panneau avant conformément à la procédure ci-dessous:
 - A. Connectez Mic_IN (MIC) à MIC2_L.
 - B. Connectez Audio_R (RIN) à OUT2_R et Audio_L (LIN) à OUT2_L.
 - C. Connectez Ground (GND) à Ground (GND).
 - D. MIC_RET et OUT_RET sont réservés au panneau audio HD. Vous n'avez pas besoin de les connecter pour le panneau audio AC'97.
 - E. Pour activer le micro avant.

Pour les systèmes d'exploitation Windows® XP / XP 64 bits :
Sélectionnez "Mixer". Sélectionnez "Recorder" (Enregistreur). Puis cliquez sur "FrontMic" (Micro avant).

Pour les systèmes d'exploitation Windows® 7 / 7 64 bits / Vista™ / Vista™ 64 bits :
Allez sur l'onglet "FrontMic" (Micro avant) sur le Panneau de contrôle Realtek. Ajustez "Recording Volume" (Volume d'enregistrement).

En-tête du panneau système
(PANEL1 br. 9)
(voir p.2 No. 18)

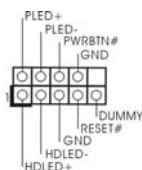

Cet en-tête permet d'utiliser plusieurs fonctions du panneau système frontal.



Connectez l'interrupteur d'alimentation, l'interrupteur de réinitialisation et l'indicateur d'état du système du châssis sur cette barrette en respectant l'affectation des broches décrite ci-dessous. Faites attention aux broches positives et négatives avant de connecter les câbles.

PWRBTN (Interrupteur d'alimentation):

Connectez ici le connecteur d'alimentation sur le panneau avant du châssis. Vous pouvez configurer la façon de mettre votre système hors tension avec l'interrupteur d'alimentation.

RESET (Interrupteur de réinitialisation):

Connectez ici le connecteur de réinitialisation sur le panneau avant du châssis. Appuyez sur l'interrupteur de réinitialisation pour redémarrer l'ordinateur s'il se bloque ou s'il n'arrive pas à redémarrer normalement.

PLED (DEL alimentation système):

Connectez ici l'indicateur d'état de l'alimentation sur le panneau avant du châssis. Ce voyant DEL est allumé lorsque le système est en marche. Le voyant DEL clignote lorsque le système est en mode veille S1/S3. Le voyant DEL est éteint lorsque le système est en mode veille S4 ou lorsqu'il est éteint (S5).

HDLED (DEL activité du disque dur):

Connectez ici le voyant DEL d'activité du disque dur sur le panneau avant du châssis. Ce voyant DEL est allumé lorsque le disque dur est en train de lire ou d'écrire des données.

Le design du panneau avant peut varier en fonction du châssis. Un module de panneau avant consiste principalement en : interrupteur d'alimentation, interrupteur de réinitialisation, voyant DEL d'alimentation, voyant DEL d'activité du disque dur, haut-parleur, etc. Lorsque vous connectez le panneau avant de votre châssis sur cette barrette, vérifiez bien à faire correspondre les fils et les broches.

En-tête du haut-parleur
de châssis
(SPEAKER1 br. 4)
(voir p.2 No. 16)

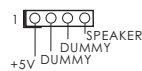

Veillez connecter le
haut-parleur de châssis sur cet
en-tête.

LED di accensione

(PLED1 br. 3)
(voir p.2 Nr. 17)



Collegare il LED di accensione chassi per indicare lo stato di alimentazione del sistema. Il LED è acceso quando il sistema è in funzione. Il LED continua a lampeggiare in stato S1/S3. Il LED è spento in stato S4 o S5 (spegnimento).

Connecteur pour châssis et ventilateur

(CHA_FAN1 br. 4)
(voir p.2 No. 22)



(CHA_FAN2 br. 3)
(voir p.2 No. 35)

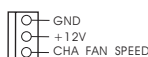

(PWR_FAN1 br. 3)
(voir p.2 No. 2)

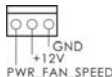

Branchez les câbles du ventilateur aux connecteurs pour ventilateur et faites correspondre le fil noir à la broche de terre. CHA_FAN1 et CHA_FAN2 prennent en charge la fonction contrôle du ventilateur.

Connecteur du ventilateur de l'UC

(CPU_FAN1 br. 4)
(voir p.2 No. 3)

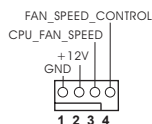

Veuillez connecter le câble de ventilateur d'UC sur ce connecteur et brancher le fil noir sur la broche de terre.



Bien que cette carte mère offre un support de (Ventilateur silencieux ventilateur de CPU à 4 broches , le ventilateur de CPU à 3 broches peut bien fonctionner même sans la fonction de commande de vitesse du ventilateur. Si vous prévoyez de connecter le ventilateur de CPU à 3 broches au connecteur du ventilateur de CPU sur cette carte mère, veuillez le connecter aux broches 1-3.

Installation de ventilateur à 3 broches

Broches 1-3 connectées

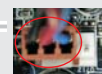

(CPU_FAN2 br. 3)
(voir p.2 No. 1)

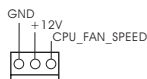

En-tête d'alimentation ATX
(ATXPWR1 br. 24)
(voir p.2 No. 8)

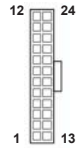

Veillez connecter l'unité d'alimentation ATX sur cet en-tête.



Bien que cette carte mère fournisse un connecteur de courant ATX 24 broches, elle peut encore fonctionner si vous adoptez une alimentation traditionnelle ATX 20 broches. Pour utiliser une alimentation ATX 20 broches, branchez à l'alimentation électrique ainsi qu'aux broches 1 et 13.

20-Installation de l'alimentation électrique ATX

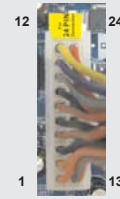

Connecteur ATX 12V
(ATX12V1 br.8)
(voir p.2 No. 4)



Veillez connecter une unité d'alimentation électrique ATX 12V sur ce connecteur.



Bien que cette carte mère possède 8 broches connecteur d'alimentation ATX 12V, il peut toujours travailler si vous adoptez une approche traditionnelle à 4 broches ATX 12V alimentation. Pour utiliser l'alimentation des 4 broches ATX, branchez votre alimentation avec la broche 1 et la broche 5.

4-Installation d'alimentation à 4 broches ATX 12V



En-tête de port COM
(COM1 br.9)
(voir p.2 No. 27)

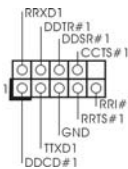

Cette en-tête de port COM est utilisée pour prendre en charge un module de port COM.

Connecteur HDMI_SPDIF
(HDMI_SPDIF1 2-pin)
(voir p.2 No. 34)



Connecteur HDMI_SPDIF,
fournissant une sortie audio
SPDIF vers la carte VGA HDMI,
et permettant au système de se
connecter au un téléviseur
numérique HDMI /un projecteur
/ un périphérique LCD. Veuillez
brancher le connecteur
HDMI_SPDIF de la carte VGA
HDMI sur ce connecteur.

2. Informations sur le BIOS

La puce Flash Memory sur la carte mère stocke le Setup du BIOS. Lorsque vous démarrez l'ordinateur, veuillez presser <F2> ou pendant le POST (Power-On-Self-Test) pour entrer dans le BIOS; sinon, le POST continue ses tests de routine. Si vous désirez entrer dans le BIOS après le POST, veuillez redémarrer le système en pressant <Ctl> + <Alt> + <Suppr>, ou en pressant le bouton de reset sur le boîtier du système. Vous pouvez également redémarrer en éteignant le système et en le rallumant. L'utilitaire d'installation du BIOS est conçu pour être convivial. C'est un programme piloté par menu, qui vous permet de faire défiler par ses divers sous-menus et de choisir parmi les choix prédéterminés. Pour des informations détaillées sur le BIOS, veuillez consulter le Guide de l'utilisateur (fichier PDF) dans le CD technique.

3. Informations sur le CD de support

Cette carte mère supporte divers systèmes d'exploitation Microsoft® Windows®: 7 / 7 64 bits / Vista™ / Vista™ 64 bits / XP / XP 64 bits. Le CD technique livré avec cette carte mère contient les pilotes et les utilitaires nécessaires pour améliorer les fonctions de la carte mère. Pour utiliser le CD technique, insérez-le dans le lecteur de CD-ROM. Le Menu principal s'affiche automatiquement si "AUTORUN" est activé dans votre ordinateur. Si le Menu principal n'apparaît pas automatiquement, localisez dans le CD technique le fichier "ASSETUP.EXE" dans le dossier BIN et double-cliquez dessus pour afficher les menus.

1. Introduzione

Grazie per aver scelto una scheda madre ASRock **Z77 Pro4-M**, una scheda madre affidabile prodotta secondo i severi criteri di qualità ASRock. Le prestazioni eccellenti e il design robusto si conformano all'impegno di ASRock nella ricerca della qualità e della resistenza.

Questa Guida Rapida all'Installazione contiene l'introduzione alla motherboard e la guida passo-passo all'installazione. Informazioni più dettagliate sulla motherboard si possono trovare nel manuale per l'utente presente nel CD di supporto.



Le specifiche della scheda madre e il software del BIOS possono essere aggiornati, pertanto il contenuto di questo manuale può subire variazioni senza preavviso. Nel caso in cui questo manuale sia modificato, la versione aggiornata sarà disponibile sul sito di ASRock senza altro avviso. Sul sito ASRock si possono anche trovare le più recenti schede VGA e gli elenchi di CPU supportate.

ASRock website <http://www.asrock.com>

Se si necessita dell'assistenza tecnica per questa scheda madre, visitare il nostro sito per informazioni specifiche sul modello che si sta usando. www.asrock.com/support/index.asp

1.1 Contenuto della confezione

Scheda madre ASRock **Z77 Pro4-M**

(Micro ATX Form Factor: 9.6-in x 9.6-in, 24.4 cm x 24.4 cm)

Guida di installazione rapida ASRock **Z77 Pro4-M**

CD di supporto ASRock **Z77 Pro4-M**

Due cavi dati Serial ATA (SATA) (opzionali)

Un I/O Shield



ASRock vi ricorda...

Per ottenere migliori prestazioni in Windows® 7 / 7 64-bit / Vista™ / Vista™ 64-bit, si consiglia di impostare l'opzione BIOS in Storage Configuration (Configurazione di archiviazione) sulla modalità AHCI. Per l'impostazione BIOS, fare riferimento a "User Manual" (Manuale dell'utente) nel CD di supporto per dettagli.

1.2 Specifiche

Piattaforma	<ul style="list-style-type: none"> - Micro ATX Form Factor: 9.6-in x 9.6-in, 24.4 cm x 24.4 cm - Design condensatore robusto (condensatori a polimeri conduttivi di altissima qualità 100% made in Japan)
Processore	<ul style="list-style-type: none"> - Supporta Intel® Core™ i7 / i5 / i3 di 3a e 2a generazione in un pacchetto LGA1155 - Design Digi Power - Struttura di fase con alimentazione 4 + 2 - Supporto della tecnologia Intel® Turbo Boost 2.0 - Supporta CPU unlocked serie K - Supporto tecnologia Hyper Threading (vedi ATTENZIONE 1) - Supporta tecnologia Intel® Rapid Start Technology e Smart Connect Technology con CPU Intel® Ivy Bridge
Chipset	- Intel® Z77
Memoria	<ul style="list-style-type: none"> - Supporto tecnologia Dual Channel Memory (vedi ATTENZIONE 2) - 4 x slots DDR3 DIMM - Supporto DDR3 2800+(OC)/2400(OC)/2133(OC)/1866(OC)/1600/1333/1066 non-ECC, memoria senza buffer - Capacità massima della memoria di sistema: 32GB (vedi ATTENZIONE 3) - Supporto di Intel® XMP (Extreme Memory Profile) 1.3/1.2
Slot di espansione	<ul style="list-style-type: none"> - 1 x Alloggio PCI Express 3.0 x16 (PCIE1 : modalità x16) (vedi ATTENZIONE 4) * PCIE 3.0 è supportato soltanto con la CPU Intel® Ivy Bridge. Con la CPU Intel® Sandy Bridge, supporta solamente PCIE 2.0. - 2 x Alloggio PCI Express 2.0 x16 (PCIE3 : modalità x1; PCIE4 : modalità x4) - 1 x Alloggio PCI Express 2.0 x1 - Supporto di AMD Quad CrossFireX™ e CrossFireX™
VGA su scheda	<ul style="list-style-type: none"> * Le uscite Intel® HD Graphics Built-in Visuals e VGA possono essere supportate solo con processori dotati di GPU integrata. - Supporta Intel® HD Graphics Built-in Visuals: Intel® Quick Sync Video 2.0, Intel® InTru™ 3D, Intel® Clear Video HD Technology, Intel® Insider™, Intel® HD Graphics 2500/4000 - Pixel Shader 5.0, DirectX 11 con CPU Intel® Ivy Bridge, Pixel Shader 4.1, DirectX 10.1 con CPU Intel® Sandy Bridge - Memoria massima condivisa 1760MB (vedi ATTENZIONE 5) - Tre opzioni d'output VGA: D-Sub, DVI-D e HDMI (vedi ATTENZIONE 6)

Italiano

	<ul style="list-style-type: none"> - Supporta HDMI 1.4a con risoluzione massima fino a 1920x1200 @ 60Hz - Supporta DVI con risoluzione massima fino a 1920x1200 @ 60Hz - Supporta D-Sub con risoluzione massima fino a 2048x1536 @ 75Hz - Supporto delle funzioni Auto Lip Sync, Deep Color (12bpc), xvYCC e HBR (High Bit Rate Audio) con HDMI (è necessario un monitor compatibile HDMI) (vedi ATTENZIONE 7) - Supporto della funzione HDCP con le porte DVI e HDMI - Supporto 1080p Blu-ray (BD) / HD-DVD riproduzione con le porte DVI e HDMI
Audio	<ul style="list-style-type: none"> - 7.1 CH HD Audio con protezioni contenuti (Realtek ALC892 Audio Codec) - Supporto audio Blu-ray Premium - Supporto THX TruStudio™
LAN	<ul style="list-style-type: none"> - PCIE x1 Gigabit LAN 10/100/1000 Mb/s - Realtek RTL8111E - Supporta Wake-On-LAN - Supporta il rilevamento cavo LAN - Supporto di Energy Efficient Ethernet 802.3az - Supporta PXE
Pannello posteriore I/O	<p>I/O Panel</p> <ul style="list-style-type: none"> - 1 x porta PS/2 per tastiera - 1 x Porta D-Sub - 1 x Porta DVI-D - 1 x Porta HDMI - 1 x Porta ottica SPDIF Out - 4 x porte USB 2.0 già integrate - 1 x Connettore eSATA3 - 2 x porte USB 3.0 già integrate - 1 x porte LAN RJ-45 con LED (LED azione/collegamento e LED velocità) - Connettore HD Audio: cassa posteriore / cassa centrale / bassi / ingresso linea / cassa frontale / microfono (vedi ATTENZIONE 8)
SATA3	<ul style="list-style-type: none"> - 2 x Connettori SATA3 6,0Gb/s Z77 Intel®, supporto RAID (RAID 0, RAID 1, RAID 5, RAID 10, Intel Rapid Storage e tecnologia Intel Smart Response) e delle funzioni NCQ, AHCI e Hot Plug - 2 x Connettori SATA3 6,0Gb/s ASM1061 ASMedia, supporto delle funzioni NCQ, AHCI e Hot Plug (il connettore SATA3_A1

	è condiviso con la porta eSATA3)
USB 3.0	<ul style="list-style-type: none"> - 2 x porte USB 3.0 posteriori amministrato dal controller, supporto di USB 1.0/2.0/3.0 fino a 5Gb/s - 1 x header USB 3.0 frontale (supporta 4 porte USB 3.0) amministrato dal controller, supporto di USB 1.0/2.0/3.0 fino a 5Gb/s
Connettori	<ul style="list-style-type: none"> - 4 x connettori SATA2 3.0Go/s, supporta RAID (RAID 0, RAID 1, RAID 5, RAID 10, Intel Rapid Storage e tecnologia Intel Smart Response) e delle funzioni NCQ, AHCI e Hot Plug - 4 x connettori SATA3 6.0Go/s - 1 x Collettore modulo infrarossi - 1 x Collettore modulo infrarosso consumer - 1 x Collettore porta stampante - 1 x collettore porta COM - 1 x connettore HDMI_SPDIF - 1 x LED di accensione - Connettore CPU/Chassis/potenza Alimentazione ventola - 24-pin collettore alimentazione ATX - 8-pin connettore ATX 12V - Connettore audio sul pannello frontale - 3 x Collettore USB 2.0 (supporta 6 porte USB 2.0) - 1 x Collettore USB 3.0 (supporta 2 porte USB 3.0)
BIOS	<ul style="list-style-type: none"> - 64Mb AMI UEFI Legal BIOS con interfaccia di supporto - Supporta "Plug and Play" - Compatibile con ACPI 1.1 wake up events - Supporta jumperfree - Supporta SMBIOS 2.3.1 - Regolazione multi-voltaggio CPU Core, IGPU, DRAM, 1.8V PLL, VTT, VCCSA
CD di supporto	<ul style="list-style-type: none"> - Driver, Utilità, Software AntiVirus (versione di prova), CyberLink MediaEspresso 6.5 Trial, Suite multimediale ASRock MAGIX - OEM
Caratteristica speciale	<ul style="list-style-type: none"> - ASRock Extreme Tuning Utility (AXTU) (vedi ATTENZIONE 9) - ASRock Instant Boot - ASRock Instant Flash (vedi ATTENZIONE 10) - Caricatore ASRock APP Charger (vedi ATTENZIONE 11) - ASRock SmartView (vedi ATTENZIONE 12) - ASRock XFast USB (vedi ATTENZIONE 13) - ASRock XFast LAN (vedi ATTENZIONE 14) - ASRock XFast RAM (vedi ATTENZIONE 15) - ASRock Crashless BIOS (vedi ATTENZIONE 16)

Italiano

	<ul style="list-style-type: none"> - ASRock OMG (Online Management Guard) (see CAUTION 17) - Lucid Virtu Universal MVP (vedi ATTENZIONE 18) * Lucid Virtu Universal MVP può essere supportato solo con processori dotati di GPU integrata. - Tecnologia ASRock On/Off Play (vedi ATTENZIONE 19) - Booster ibrido: <ul style="list-style-type: none"> - Stepless control per frequenza del processore (vedi ATTENZIONE 20) - ASRock U-COP (vedi ATTENZIONE 21) - Boot Failure Guard (B.F.G.) - Opzione C.C.O. (Combo Cooler Option) (vedi ATTENZIONE 22) - LED notturno
Monitoraggio Hardware	<ul style="list-style-type: none"> - Sensore per la temperatura del processore - Sensore temperatura scheda madre - Indicatore di velocità per la ventola del CPU/Chassis/potenza Alimentazione - Ventola CPU/Chassis silenziosa (permette la regolazione automatica della ventola dello chassis in base alla temperatura della CPU) - Ventola CPU/chassis con controllo di varie velocità - Voltaggio: +12V, +5V, +3.3V, Vcore
Compatibilità SO	<ul style="list-style-type: none"> - Microsoft® Windows® 7 / 7 64 bit / Vista™ / Vista™ 64 bit / XP / XP 64 bit (vedi ATTENZIONE 23)
Certificazioni	<ul style="list-style-type: none"> - FCC, CE, WHQL - Predisposto ErP/EuP (è necessaria l'alimentazione predisposta per il sistema ErP/EuP) (vedi ATTENZIONE 24)

* Per ulteriori informazioni, prego visitare il nostro sito internet: <http://www.asrock.com>

AVVISO

Si prega di prendere atto che la procedura di overlocking implica dei rischi, come anche la regolazione delle impostazioni del BIOS, l'applicazione della tecnologia Untied Overclocking Technology, oppure l'uso di strumenti di overlocking forniti da terzi. L'overclocking può influenzare la stabilità del sistema, ed anche provocare danni ai componenti ed alle periferiche del sistema. La procedura è eseguita a proprio rischio ed a proprie spese. Noi non possiamo essere ritenuti responsabili per possibili danni provocati dall'overlocking.

ATTENZIONE!

1. Per il settaggio della "Tecnologia Hyper-Threading", per favore controllare pagina 52 del Manuale dell'utente all'interno del CD di supporto.
2. Questa scheda madre supporta la tecnologia Dual Channel Memory. Prima di implementare la tecnologia Dual Channel Memory, assicurarsi di leggere la guida all'installazione dei moduli di memoria, a pagina 17, per seguire un'installazione appropriata.
3. A causa delle limitazioni del sistema operativo, le dimensioni effettive della memoria possono essere inferiori a 4GB per l'accantonamento riservato all'uso del sistema sotto Windows® 7 / Vista™ / XP. Per Windows® OS con CPU 64-bit, non c'è tale limitazione. Si può usare ASRock XFast RAM per fare uso della memoria che Windows® non può utilizzare.
4. Solo lo slot PCIE1 supporta velocità fino a Gen 3. Per utilizzare PCI Express a velocità Gen 3, bisogna installare la CPU Ivy Bridge. Se si installa la CPU Sandy Bridge, PCI Express opererà soltanto a velocità Gen 2 PCI Express.
5. La dimensione massima della memoria condivisa viene stabilita dal venditore del chipset ed è soggetta a modificazioni. Prego fare riferimento al sito internet Intel® per le ultime informazioni.
6. Si può solo scegliere di usare due dei tre monitor. I monitor D-Sub, DVI-D e HDMI non possono essere abilitati contemporaneamente. Inoltre, usando l'adattatore DVI a HDMI la porta DVI-D può supportare le stesse funzioni della porta HDMI.
7. Le funzioni xvYCC e Deep Color sono supportate solo sotto Windows® 7 64-bit / 7. La modalità Deep Color sarà abilitata solo se lo schermo supporta la funzione 12bpc in EDID. La funzione HBR è supportata sotto Windows® 7 64-bit / 7 / Vista™ 64-bit / Vista™.
8. Questa scheda madre supporta l'ingresso stereo e mono per il microfono. Questa scheda madre supporta le modalità 2 canali, 4 canali, 6 canali e 8 canali per l'uscita audio. Controllare la tavola a pagina 3 per eseguire il collegamento appropriato.
9. L'utilità AXTU (ASRock Extreme Tuning Utility) è uno strumento tutto in uno per regolare varie funzioni del sistema in un'interfaccia facile da usare che include monitoraggio hardware, controllo ventola, overclocking, OC DNA ed IES. Hardware Monitor (Monitoraggio hardware) mostra le letture principali del sistema. Fan Control (Controllo ventola) mostra la velocità e la temperatura che possono essere regolate. Overclocking permette di eseguire l'overclocking della frequenza della CPU per ottenere le prestazioni ottimali del sistema. OC DNA permette di salvare le impostazioni OC come un profilo da condividere con gli amici! Gli amici possono scaricare il profilo OC sul loro sistema operativo per ottenere le stesse impostazioni OC. Il regolatore di tensione di IES (Intelligent Energy Saver) può ridurre il numero di fasi d'uscita per migliorare l'efficienza quando i core CPU sono inattivi senza sacrificare le prestazioni di computazione. Visitare il nostro per informazioni sulle procedure operative dell'utilità AXTU (ASRock Extreme Tuning Utility).
Sito ASRock: <http://www.asrock.com>

10. ASRock Instant Flash è una utilità Flash BIOS integrata nella Flash ROM. Questo comodo strumento d'aggiornamento del BIOS permette di aggiornare il sistema BIOS senza accedere a sistemi operativi come MS-DOS or Windows®. Con questa utilità, si può premere il tasto <F6> durante il POST, oppure il tasto <F2> nel menu BIOS per accedere ad ASRock Instant Flash. Avviare questo strumento e salvare il nuovo file BIOS nell'unità Flash USB, dischetto (disco floppy) o disco rigido; poi si può aggiornare il BIOS con pochi clic, senza preparare altri dischetti (dischi floppy) o altre complicate utilità Flash. Si prega di notare che l'unità Flash USB o il disco rigido devono usare il File System FAT32/16/12.
11. Se vuoi un modo rapido e indipendente per caricare i dispositivi Apple, come iPhone/iPad/iPod Touch, ASRock ha preparato una soluzione meravigliosa: ASRock APP Charger. Basta installare il driver APP Charger per caricare l'iPhone più rapidamente rispetto al computer, con una velocità maggiore del 40%. ASRock APP Charger permette di caricare simultaneamente molti dispositivi Apple in modo rapido e supporta anche il caricamento continuato quando il PC accede alla modalità di Standby (S1), Sospensione su RAM (S3), Ibernazione (S4) o Spegnimento (S5). Una volta installato il driver APP Charger si otterranno prodigi e comodità mai avuti prima.
Sito ASRock: <http://www.asrock.com/Feature/AppCharger/index.asp>
12. SmartView, una nuova funzione di browser Internet, è la pagina iniziale intelligente di IE che unisce i siti web più visitati, la cronologia, gli amici di Facebook e il newsfeed in tempo reale in una visione migliorata per una esperienza Internet più personale. Le schede madri ASRock sono dotate in modo esclusivo dell'utilità SmartView, che consente di mantenersi sempre in contatto con gli amici. Per utilizzare la funzione SmartView, assicurarsi che la versione del sistema operativo sia Windows® 7 / 7 64 bit / Vista™ / Vista™ 64 bit e che la versione del browser sia IE8. Sito web ASRock: <http://www.asrock.com/Feature/SmartView/index.asp>
13. ASRock XFast USB può accelerare le prestazioni del dispositivo d'archiviazione USB. Le prestazioni dipendono dalle proprietà del dispositivo.
14. ASRock XFast LAN offre un accesso a Internet più veloce, che comprende i seguenti benefici. Priorità alle applicazioni LAN: è possibile configurare la priorità assegnata alle applicazioni in modo ideale e/o aggiungere nuovi programmi. Minore latenza nei giochi: dopo avere impostato la priorità dei giochi su un livello più alto, la latenza dei giochi può essere minore. Configurazione del traffico: è possibile seguire video HD su Youtube e scaricare file contemporaneamente. Analisi in tempo reale dei dati: grazie alla finestra di stato, è possibile riconoscere con facilità quali dati si stanno trasferendo in streaming.
15. ASRock XFast RAM è una nuova funzione inclusa in ASRock Extreme Tuning Utility (AXTU). Utilizza completamente lo spazio che non può essere utilizzato da CPU Windows® 32-bit. ASRock XFast RAM accorcia i tempi di caricamento dei siti visitati in precedenza, rendendo la navigazione più veloce che mai. Inoltre accelera di 5 volte la velocità di Adobe Photoshop. Un altro vantaggio di ASRock XFast RAM è che riduce la frequenza d'accesso alle unità SSD o HDD per allungare la loro durata.

16. ASRock Crashless BIOS permette agli utenti di aggiornare il BIOS senza paura di commettere errori. Se si verifica un blackout durante la procedura di aggiornamento del BIOS, ASRock Crashless BIOS terminerà automaticamente la procedura di aggiornamento del BIOS quando è ripristinata la corrente. Notare che i file del BIOS devono essere collocati nella directory principale del disco USB. Questa funzione è supportata solo dalle porte USB2.0.
17. Con OMG, gli amministratori sono in grado di stabilire un coprifuoco Internet, oppure di limitare l'accesso ad Internet in determinati orari. Si può scegliere tra [Ogni giorno], [Feriali] o [Feriali e festivi], e poi pianificare l'ora d'inizio e di fine che definisce l'intervallo durante il quale ad altri utenti è garantito l'accesso ad Internet. Per impedire agli utenti di bypassare l'OMG, sono necessari account ospite senza autorizzazione a modificare l'ora del sistema.
18. VIRTU Universal MVP include le funzioni base della tecnologia Virtu Universal, che virtualizza GPU integrata e GPU discreta per funzionalità ottimali. È inoltre dotato di Virtual Vsync™ per una qualità visiva perfetta. Con i vantaggi supplementari della tecnologia HyperFormance, VIRTU Universal MVP migliora le prestazioni nei giochi riducendo in modo intelligente le ridondanti attività di rendering nel flusso tra CPU, GPU e display.
19. La tecnologia ASRock On/Off Play consente agli utenti di godere di una esperienza audio eccezionale tramite i dispositivi audio portatili come i lettori MP3 o il cellulare sul proprio PC, anche quando il PC è spento (oppure in modalità ACPI S5)! Questa scheda madre fornisce inoltre un cavo audio libero da 3,5 mm (opzionale) che garantisce agli utenti l'ambiente di elaborazione più comodo.
20. Anche se questa motherboard offre il controllo stepless, non si consiglia di effettuare l'overclocking. Frequenze del bus del processore diverse da quelle raccomandate possono causare instabilità al sistema o danni al processore e alla scheda madre.
21. Se il processore si surriscalda, il sistema si chiude automaticamente. Prima di riavviare il sistema, assicurarsi che la ventolina CPU della scheda madre funzioni correttamente; scollegare e ricollegare il cavo d'alimentazione. Per migliorare la dissipazione del calore, ricordare di applicare l'apposita pasta siliconica tra il processore e il dissipatore quando si installa il sistema.
22. L'opzione C.C.O. (Combo Cooler Option) fornisce la flessibilità di impiegare tre tipi diversi di dispersori di calore CPU, Socket LGA 775, LGA 1155 e LGA 1156. Notare che non possono essere usate tutte le ventole CPU 775 e 1156.
23. ASRock XFast RAM non è supportato da Microsoft® Windows® XP / XP 64-bit. Intel® Smart Connect Technology e Intel® porte USB 3.0 non è supportato da Microsoft® Windows® Vista™ / Vista™ 64 bit / XP / XP 64 bit.
24. EuP, che sta per Energy Using Product (Prodotto che consuma energia), era una normativa emanata dall'Unione Europea che definiva il consumo energetico del sistema completo. In base all'EuP, l'alimentazione totale

del sistema completo deve essere inferiore a 1,00 W quando è spento. Per soddisfare la norma EuP sono necessari un alimentatore e una scheda elettrica predisposti EuP. In base ai suggerimenti Intel l'alimentatore predisposto EuP deve soddisfare lo standard secondo cui l'efficienza energetica in standby di 5 v è più alta del 50% con un consumo di corrente di 100 mA. Per la scelta di un'alimentatore predisposto EuP consigliamo di verificare ulteriori dettagli con il produttore.

1.3 Setup dei Jumpers

L'illustrazione mostra come sono settati i jumper. Quando il ponticello è posizionato sui pin, il jumper è "CORTOCIRCUITATO". Se sui pin non ci sono ponticelli, il jumper è "APERTO". L'illustrazione mostra un jumper a 3 pin in cui il pin1 e il pin2 sono "CORTOCIRCUITATI" quando il ponticello è posizionato su questi pin.

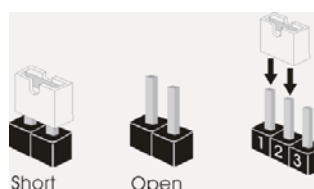

Jumper	Settaggio del Jumper		
Resettare la CMOS (CLRCMOS1) (vedi p.2 Nr. 15)	<table border="0"> <tr> <td style="text-align: center;"> 1_2 Impostazione predefinita </td> <td style="text-align: center;"> 2_3 Azzeramento CMOS </td> </tr> </table>	1_2 Impostazione predefinita	2_3 Azzeramento CMOS
1_2 Impostazione predefinita	2_3 Azzeramento CMOS		

Nota: CLRCMOS1 permette di azzerare i dati nella CMOS. Per cancellare e ripristinare i parametri del sistema sulla configurazione iniziale, spegnere il computer e scollegare il cavo d'alimentazione dalla presa di corrente. Attendere 15 secondi, poi usare un cappuccio jumper per cortocircuitare il pin 2 ed il pin 3 su CLRCMOS1 per 5 secondi. Tuttavia, si consiglia di non cancellare la CMOS subito dopo avere aggiornato il BIOS. Se si deve azzerare la CMOS quando si è completato l'aggiornamento del BIOS, è necessario per prima cosa avviare il sistema e poi spegnerlo prima di eseguire l'azzeramento della CMOS. Notare che password, data, ore, profilo utente predefinito, 1394 GUID e indirizzo MAC saranno cancellati solo se è rimossa la batteria della CMOS.

1.4 Collettori e Connettori su Scheda



I collettori ed i connettori su scheda NON sono dei jumper. NON installare cappucci per jumper su questi collettori e connettori. L'installazione di cappucci per jumper su questi collettori e connettori provocherà danni permanenti alla scheda madre!

Connettori Serial ATA2

(SATA2_2_3: vedi p.2 Nr. 14)

(SATA2_4: vedi p.2 Nr. 21)

(SATA2_5: vedi p.2 Nr. 20)

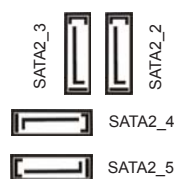

Questi quattro connettori Serial ATA2 (SATA2) supportano cavi dati SATA per dispositivi di immagazzinamento interni. L'interfaccia SATA2 attuale permette velocità di trasferimento dati fino a 3.0 Gb/s.

Serial ATA3 Connectors

(SATA3_A0_A1: vedi p.2 Nr. 12)

(SATA3_0_1: vedi p.2 Nr. 13)

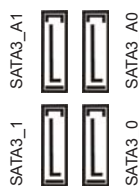

Questi quattro connettori Serial ATA3 (SATA3) supportano cavi dati SATA per dispositivi di immagazzinamento interni. L'interfaccia SATA3 attuale permette velocità di trasferimento dati fino a 6.0 Gb/s. Se si è collegata la porta eSATA3 sull'I/O posteriore, la SATA3_A1 interna non funziona.

Cavi dati Serial ATA (SATA)

(Opzionale)



Una o altra estremità del cavo di dati SATA può essere collegata al disco rigido SATA / SATA2 / SATA3 o al connettore di SATA2 / SATA3 su questa cartolina base.

Collettore porta stampante

(LPT1 25 pin)
(vedi p.2 No. 28)

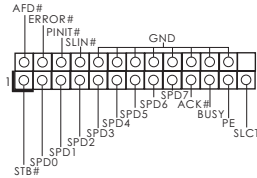

Questa è un'interfaccia per il cavo porta stampante che consente di collegare, con comodità, dispositivi di stampa.

Collettore USB 2.0

(9-pin USB_6_7)
(vedi p.2 Nr. 25)

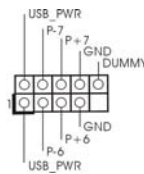

(9-pin USB_8_9)
(vedi p.2 Nr. 24)

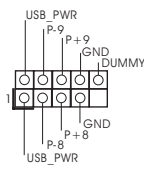

(9-pin USB_10_11)
(vedi p.2 Nr. 23)

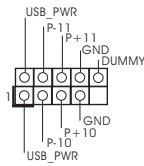

Oltre alle quattro porte USB 2.0 predefinite nel pannello I/O, la scheda madre dispone di tre intestazioni USB 2.0. Ciascuna intestazione USB 2.0 supporta due porte USB 2.0.

Collettore USB 3.0

(19-pin USB3_0_1)
(vedi p.2 Nr. 9)

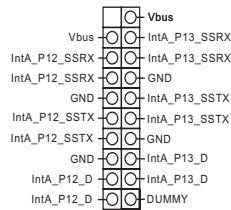

Oltre alle due porte USB 3.0 standard del pannello I/O, questa scheda madre è dotata di un header USB 3.0 che supporta due porte USB 3.0.

Collettore modulo infrarossi

(5-pin IR1)
(vedi p.2 Nr. 19)

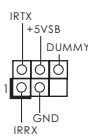

Questo collettore supporta moduli ad infrarossi optional per la trasmissione e la ricezione senza fili.

Connettore modulo infrarosso consumer

(4-pin CIR1)

(vedi p.2 Nr. 26)



Questo connettore può essere utilizzato per collegare ricevitore remoto.

Connettore audio sul pannello frontale

(9-pin HD_AUDIO1)

(vedi p.2 Nr. 33)

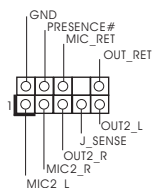

È un'interfaccia per il cavo del pannello audio. Che consente connessione facile e controllo dei dispositivi audio.



1. La caratteristica HDA (High Definition Audio) supporta il rilevamento dei connettori, però il pannello dei cavi sul telaio deve supportare la funzione HDA (High Definition Audio) per far sì che questa operi in modo corretto. Attenersi alle istruzioni del nostro manuale e del manuale del telaio per installare il sistema.

2. Se si utilizza un pannello audio AC'97, installarlo nell'installazione audio del pannello anteriore, come indicato di seguito:

- Collegare Mic_IN (MIC) a MIC2_L.
- Collegare Audio_R (RIN) a OUT2_R e Audio_L (LIN) ad OUT2_L.
- Collegare Ground (GND) a Ground (GND).
- MIC_RET e OUT_RET sono solo per il pannello audio HD. Non è necessario collegarli per il pannello audio AC'97.
- Per attivare il microfono frontale.

Sistema operativo Windows® XP / XP 64-bit:

Selezionare "Mixer". Selezionare "Recorder" (Registratore). Poi, fare clic su "FrontMic" (Microfono frontale).

Sistema operativo Windows® 7 / 7 64-bit / Vista™ / Vista™ 64-bit:

Andare alla scheda "FrontMic" (Microfono frontale) del pannello di controllo Realtek. Regolare la voce "Recording Volume" (Volume registrazione).

Collettore pannello di sistema

(9-pin PANEL1)

(vedi p.2 Nr. 18)

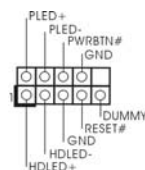

Questo collettore accomoda diverse funzioni di sistema pannello frontale.

Italiano



Collegare l'interruttore d'alimentazione, l'interruttore di ripristino, l'indicatore di stato del sistema del pannello frontale del telaio a questo header in base all'assegnazione dei pin definita di seguito. Determinare i pin positivi e negativi prima di collegare i cavi.

PWRBTN (interruttore d'alimentazione):

Va collegato all'interruttore d'alimentazione del pannello frontale del telaio. Usando l'interruttore d'alimentazione si può configurare il modo in cui si spegne il sistema.

RESET (interruttore di ripristino):

Va collegato all'interruttore di ripristino del pannello frontale del telaio. Premere l'interruttore di ripristino per riavviare il sistema se il computer si blocca e non riesce ad eseguire un normale riavvio.

PLED (LED alimentazione del sistema):

Va collegato all'indicatore di stato d'alimentazione del pannello frontale del telaio. Il LED è acceso quando il sistema è operativo. Il LED continua a lampeggiare quando il sistema è in stato di standby S1/S3. Il LED è spento quando il sistema è in stato di sospensione /ibernazione S4 oppure spento (S5).

HDLED (LED attività disco rigido):

Va collegato al LED attività disco rigido del pannello frontale del telaio. Il LED è acceso quando disco rigido legge e scrive i dati.

Il design del pannello frontale può variare in base ai telai. Il modulo di un pannello frontale può consistere di: interruttore d'alimentazione, interruttore di ripristino, LED d'alimentazione, LED attività disco rigido, casse, eccetera. Quando si collega il modulo del pannello frontale a questo header, assicurarsi che l'assegnazione dei fili e dei pin sia fatta corrispondere in modo appropriato.

Collettore casse telaio

(4-pin SPEAKER1)
(vedi p.2 Nr. 16)

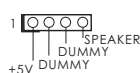

Collegare le casse del telaio a questo collettore.

LED di accensione

(3-pin PLED1)
(vedi p.2 Nr. 17)



Collegare il LED di accensione chassi per indicare lo stato di alimentazione del sistema. Il LED è acceso quando il sistema è in funzione. Il LED continua a lampeggiare in stato S1/S3. Il LED è spento in stato S4 o S5 (spegnimento).

Collettori Chassis ed alimentazione ventola

(4-pin CHA_FAN1)

(vedi p.2 Nr. 22)

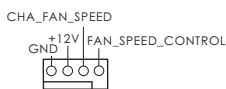

(3-pin CHA_FAN2)

(vedi p.2 Nr. 35)

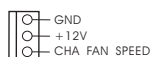

(3-pin PWR_FAN1)

(vedi p.2 Nr. 2)



Collegare i cavi della ventola ai corrispondenti connettori facendo combaciare il cavo nero col pin di terra. CHA_FAN1 e CHA_FAN2 supportano la funzione Fan Control.

Connettore ventolina CPU

(4-pin CPU_FAN1)

(vedi p.2 Nr. 3)

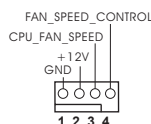

Collegare il cavo della ventolina CPU a questo connettore e far combaciare il filo nero al pin terra.



Sebbene la presente scheda madre disponga di un supporto per ventola CPU a 4 piedini (ventola silenziosa), la ventola CPU a 3 piedini è in grado di funzionare anche senza la funzione di controllo della velocità della ventola. Se si intende collegare la ventola CPU a 3 piedini al connettore della ventola CPU su questa scheda madre, collegarla ai piedini 1-3.

Piedini 1-3 collegati

Installazione della ventola a 3 piedini

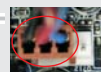

(3-pin CPU_FAN2)

(vedi p.2 Nr. 1)

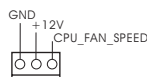

Connettore alimentazione ATX

(24-pin ATXPWR1)

(vedi p.2 Nr. 8)

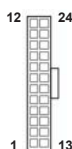

Collegare la sorgente d'alimentazione ATX a questo connettore.



Con questa scheda madre, c'è in dotazione un connettore elettrico ATX a 24 pin, ma può funzionare lo stesso se si adotta un alimentatore ATX a 20 pin. Per usare l'alimentatore ATX a 20 pin, collegare l'alimentatore con il Pin 1 e il Pin 13.

Installazione dell'alimentatore ATX a 20 pin

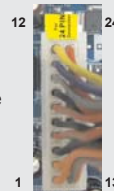

Italiano

Connettore ATX 12 V
(8-pin ATX12V1)
(vedi p.2 Nr. 4)



Collegare un alimentatore ATX 12 V a questo connettore.



Sebbene questa scheda madre fornisca un connettore elettrico 8-pin ATX 12V, l'unità può ancora essere funzionante se viene utilizzata una fornitura elettrica tradizionale a 4-pin ATX 12V. Per usare tale fornitura elettrica 4-pin ATX 12V, prego collegare la presa elettrica al Pin 1 e Pin 5.

Installazione elettrica 4-Pin ATX 12V



Collettore porta COM
(9-pin COM1)
(vedi p.2 Nr. 28)

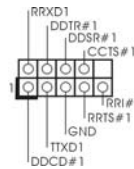

Questo collettore porta COM è utilizzato per supportare il modulo porta COM.

Header HDMI_SPDIF
(2-pin HDMI_SPDIF1)
(vedi p.2 Nr. 29)



Header HDMI_SPDIF, con uscita audio SPDIF su scheda HDMI VGA, consente al sistema di collegare dispositivi per TV digitale HDMI/proiettori/LCD. Collegare il connettore HDMI_SPDIF della scheda HDMI_SPDIF della scheda VGA HDMI a questo header.

2. Informazioni sul BIOS

La Flash Memory sulla scheda madre contiene le Setup Utility. Quando si avvia il computer, premi <F2> o durante il Power-On-Self-Test (POST) della Setup utility del BIOS; altrimenti, POST continua con i suoi test di routine. Per entrare il BIOS Setup dopo il POST, riavvia il sistema premendo <Ctl> + <Alt> + <Delete>, o premi il tasto di reset sullo chassis del sistema. Per informazioni più dettagliate circa il Setup del BIOS, fare riferimento al Manuale dell'Utente (PDF file) contenuto nel cd di supporto.

3. Software di supporto e informazioni su CD

Questa scheda madre supporta vari sistemi operativi Microsoft® Windows®: 7 / 7 64-bit / Vista™ / Vista™ 64-bit / XP / XP 64-bit. Il CD di supporto a corredo della scheda madre contiene i driver e utilità necessari a potenziare le caratteristiche della scheda.

Inserire il CD di supporto nel lettore CD-ROM. Se la funzione "AUTORUN" è attivata nel computer, apparirà automaticamente il Menù principale. Se il Menù principale non appare automaticamente, posizionarsi sul file "ASSETUP.EXE" nel CESTINO del CD di supporto e cliccare due volte per visualizzare i menù.

1. Introducción

Gracias por su compra de ASRock **Z77 Pro4-M** placa madre, una placa de confianza producida bajo el control de calidad estricto y persistente. La placa madre provee realización excelente con un diseño robusto conforme al compromiso de calidad y resistencia de ASRock.

Esta Guía rápida de instalación contiene una introducción a la placa base y una guía de instalación paso a paso. Puede encontrar una información más detallada sobre la placa base en el manual de usuario incluido en el CD de soporte.



Porque las especificaciones de la placa madre y el software de BIOS podrían ser actualizados, el contenido de este manual puede ser cambiado sin aviso. En caso de cualquier modificación de este manual, la versión actualizada estará disponible en el website de ASRock sin previo aviso.

También encontrará las listas de las últimas tarjetas VGA y CPU soportadas en la página web de ASRock.

Website de ASRock <http://www.asrock.com>

Si necesita asistencia técnica en relación con esta placa base, visite nuestra página web con el número de modelo específico de su placa.

www.asrock.com/support/index.asp

1.1 Contenido de la caja

Placa base ASRock **Z77 Pro4-M**

(Factor forma Micro ATX: 24,4 cm x 24,4 cm, 9,6" x 9,6")

Guía de instalación rápida de ASRock **Z77 Pro4-M**

CD de soporte de ASRock **Z77 Pro4-M**

Dos cables de datos Serial ATA (SATA) (Opcional)

Una protección I/O



ASRock le recuerda...

Para mejorar el rendimiento en Windows® 7 / 7 64 bits / Vista™ / Vista™ 64 bits, es recomendable establecer la opción del BIOS de la configuración de almacenamiento en el modo AHCI. Para obtener detalles sobre la configuración del BIOS, consulte el "Manual del usuario" que se encuentra en nuestro CD de soporte.

1.2 Especificación

Plataforma	<ul style="list-style-type: none"> - Factor forma Micro ATX: 24,4 cm x 24,4 cm, 9,6" x 9,6" - Todo diseño de Capacitor Sólido (condensadores de polímero conductor de alta calidad de fabricación 100% japonesa)
Procesador	<ul style="list-style-type: none"> - Admite procesadores Intel® Core™ i7 / i5 / i3 de la 3ª y 2ª generación en el paquete LGA1155 - Diseño de alimentación digital - Diseño de fases de potencia 4 + 2 - Admite la tecnología Intel® Turbo Boost 2.0 Technology - Admite procesador desbloqueado de la serie K - Admite tecnología Hyper Threading (ver ATENCIÓN 1) - Admite las tecnologías Intel® Rapid Start y Smart Connect con la CPU Intel® Ivy Bridge
Chipset	- Intel® Z77
Memoria	<ul style="list-style-type: none"> - Soporte de Tecnología de Memoria de Doble Canal (ver ATENCIÓN 2) - 4 x DDR3 DIMM slots - Apoya DDR3 2800+(OC)/2400(OC)/2133(OC)/1866(OC)/1600/1333/1066 non-ECC, memoria de un-buffered - Máxima capacidad de la memoria del sistema: 32GB (vea ATENCIÓN 3) - Compatible con Intel® Extreme Memory Profile (XMP)1.3/1.2
Ranuras de Expansión	<ul style="list-style-type: none"> - 1 x ranura PCI Express 3.0 x16 (PCIE1: modo x16) (vea ATENCIÓN 4) * PCIE 3.0 solamente se admite con una CPU Intel® Ivy Bridge. Con una CPU Intel® Sandy Bridge, solamente admite PCIE 2.0. - 2 x ranuras PCI Express 2.0 x16 (PCIE3: modo x1; PCIE4: modo x4) - 1 x ranura PCI Express 2.0 x1 - Compatible con AMD Quad CrossFireX™ y CrossFireX™
VGA OnBoard	<ul style="list-style-type: none"> * Los efectos visuales incorporados con gráficos de alta definición Intel® y las salidas VGA sólo se soportan con procesadores con GPU integrada. - Admite Intel® HD Graphics Built-in Visuals: Intel® Quick Sync Video 2.0, Intel® InTru™ 3D, Intel® Clear Video HD Technology, Intel® Insider™, Intel® HD Graphics 2500/4000 - Pixel Shader 5.0, DirectX 11 con CPU Intel® Ivy Bridge, Pixel Shader 4.1, DirectX 10.1 con CPU Intel® Sandy Bridge

	<ul style="list-style-type: none"> - 1760MB de Memoria máxima compartida (vea ATENCIÓN 5) - Tres opciones de salida VGA: D-Sub, DVI-D y HDMI (vea ATENCIÓN 6) - Admite HDMI 1.4a con una resolución máxima de 1920x1200 a 60 Hz - Admite DVI con una resolución máxima de 1920x1200 a 60 Hz - Admite D-Sub con una resolución máxima de 2048x1536 a 75 Hz - Admite Sincronización automática entre audio y vídeo, Deep Color (12 bpc), xvYCC y HBR (audio de alta tasa de bits) con HDMI (se necesita un monitor compatible con HDMI) (ver ATENCIÓN 7) - Admite la función HDCP con puertos DVI y HDMI - Apoya la reproducción de Blu-ray de 1080p (BD) / HD-DVD con puertos DVI y HDMI
Audio	<ul style="list-style-type: none"> - 7.1 CH HD Audio con Protección de Contenido (Realtek ALC892 Audio Codec) - Compatible con audio Blu-ray de alta calidad - Compatible con THX TruStudio™
LAN	<ul style="list-style-type: none"> - PCIE x1 Gigabit LAN 10/100/1000 Mb/s - Realtek RTL8111E - Soporta Wake-On-LAN - Admite detección de conexión de cable LAN - Compatible con Ethernet 802.3az de bajo consumo energético - Compatible con PXE
Entrada/Salida de Panel Trasero	<p>I/O Panel</p> <ul style="list-style-type: none"> - 1 x puerto de teclado PS/2 - 1 x puerto D-Sub - 1 x puerto DVI-D - 1 x puerto HDMI - 1 x puerto de salida óptica SPDIF - 4 x puertos USB 2.0 predeterminados - 1 x Conector eSATA3 - 2 x puertos USB 3.0 predeterminados - 1 x Puerto LAN RJ-45 con LED (LED de ACCIÓN/ENLACE y LED de VELOCIDAD) - Conexión de audio: Altavoz trasero / Central / Bajos / Entrada de línea / Altavoz frontal / Micrófono (ver ATENCIÓN 8)

SATA3	<ul style="list-style-type: none"> - 2 x conectores SATA3 de 6,0 Gb/s con chip Intel® Z77 con funciones RAID (RAID 0, RAID 1, RAID 5, RAID 10, Intel Rapid Storage y tecnología Intel Smart Response), NCQ, AHCI y de Hot Plug (conexión en caliente) - 2 x conectores SATA3 de 6,0 Gb/s con chip ASMedia ASM1061 con funciones NCQ, AHCI y de Hot Plug (conexión en caliente) (los puertos SATA3_A1 y eSATA3 son compartidos)
USB 3.0	<ul style="list-style-type: none"> - 2 x puertos USB 3.0 traseros, compatible con USB 1.0/2.0/3.0 de hasta 5 GB/s - 1 x cabecera USB 3.0 delantera (compatible con 2 puertos USB 3.0), compatible con USB 1.0/2.0/3.0 de hasta 5 GB/s
Conectores	<ul style="list-style-type: none"> - 4 x conexiones SATA2, admiten una velocidad de transferencia de datos de hasta 3,0Gb/s, soporta RAID (RAID 0, RAID 1, RAID 5, RAID 10, Intel Rapid Storage y tecnología Intel Smart Response), NCQ, AHCI y de Hot Plug (conexión en caliente) - 4 x conexiones SATA3, admiten una velocidad de transferencia de datos de hasta 6,0Gb/s - 1 x Cabezal de Módulo Infrarrojos - 1 x Base de conexiones del módulo de infrarrojos para el consumidor - 1 x cabecera de puerto de impresora - 1x En-tête de port COM - 1 x cabecera HDMI_SPDIF - 1 x cabecera de indicador LED de encendido - Conector de ventilador de CPU / chasis / alimentación - 24-pin cabezal de alimentación ATX - 8-pin conector de ATX 12V power - Conector de audio de panel frontal - 3 x Cabezal USB 2.0 (admite 6 puertos USB 2.0 adicionales) - 1 x Cabezal USB 3.0 (admite 2 puertos USB 3.0 adicionales)
BIOS	<ul style="list-style-type: none"> - 64Mb AMI BIOS legal UEFI AMI compatible con GUI - Soporta "Plug and Play" - ACPI 1.1 compliance wake up events - Soporta "jumper free" - Soporta SMBIOS 2.3.1 - Múltiple ajuste de CPU Core, IGPU, DRAM, 1.8V PLL, VTT, VCCSA Voltage
CD de soport	<ul style="list-style-type: none"> - Controladores, utilidades, software de antivirus (versión de prueba), Prueba de CyberLink MediaEspresso 6.5, conjunto multimedia ASRock MAGIX - OEM

Característica Única	<ul style="list-style-type: none"> - ASRock Extreme Tuning Utility (AXTU) (vea ATENCIÓN 9) - ASRock Instant Boot - ASRock Instant Flash (vea ATENCIÓN 10) - ASRock APP Charger (vea ATENCIÓN 11) - ASRock SmartView (vea ATENCIÓN 12) - ASRock XFast USB (vea ATENCIÓN 13) - ASRock XFast LAN (vea ATENCIÓN 14) - ASRock XFast RAM (vea ATENCIÓN 15) - ASRock Crashless BIOS (vea ATENCIÓN 16) - ASRock OMG (Online Management Guard) (vea ATENCIÓN 17) - Lucid Virtu Universal MVP (vea ATENCIÓN 18) <ul style="list-style-type: none"> * Lucid Virtu Universal MVP sólo se soporta con procesadores con GPU integrada. - Tecnología de activación y desactivación de la reproducción de ASRock (vea ATENCIÓN 19) - Amplificador Híbrido: <ul style="list-style-type: none"> - Stepless control de frecuencia de CPU (vea ATENCIÓN 20) - ASRock U-COP (vea ATENCIÓN 21) - Protección de Falla de Inicio (B.F.G..) - Opción de refrigeración combinada (C.C.O.) (vea ATENCIÓN 22) - Indicador LED nocturno
Monitor Hardware	<ul style="list-style-type: none"> - Sensibilidad a la temperatura del procesador - Sensibilidad a la temperatura de la placa madre - Taquímetros de los ventiladores del procesador y del CPU / chasis / alimentación - Ventilador silencioso del procesador y el chasis (ajuste automático de la velocidad del ventilador del chasis en función de la temperatura del procesador) - Control de ajuste de la velocidad del ventilador de la CPU / chasis - Monitor de Voltaje: +12V, +5V, +3.3V, Vcore
OS	<ul style="list-style-type: none"> - En conformidad con Microsoft® Windows® 7 / 7 64 bits / Vista™ / Vista™ 64 bits / XP / XP 64 bits (vea ATENCIÓN 23)
Certificaciones	<ul style="list-style-type: none"> - FCC, CE, WHQL - Cumple con la directiva ErP/EuP (se requiere una fuente de alimentación que cumpla con la directiva ErP/EuP) (vea ATENCIÓN 24)

* Para más información sobre los productos, por favor visite nuestro sitio web:

<http://www.asrock.com>

ADVERTENCIA

Tenga en cuenta que hay un cierto riesgo implícito en las operaciones de aumento de la velocidad del reloj, incluido el ajuste del BIOS, aplicando la tecnología de aumento de velocidad liberada o utilizando las herramientas de aumento de velocidad de otros fabricantes. El aumento de la velocidad puede afectar a la estabilidad del sistema e, incluso, dañar los componentes y dispositivos del sistema. Esta operación se debe realizar bajo su propia responsabilidad y Ud. debe asumir los costos. No asumimos ninguna responsabilidad por los posibles daños causados por el aumento de la velocidad del reloj.

ATENCIÓN !

1. Por favor consulte página 52 del Manual del Usuario en el soporte CD sobre la configuración de Hyper-Threading Technology.
2. Esta placa base soporta Tecnología de Memoria de Doble Canal. Antes de implementar la Tecnología de Memoria de Doble Canal, asegúrese de leer la guía de instalación de módulos de memoria en la página 17 para su correcta instalación.
3. Debido a las limitaciones del sistema, el tamaño real de la memoria debe ser inferior a 4GB para que el sistema pueda funcionar bajo Windows® 7 / Vista™ / XP. Para equipos con Windows® OS con CPU de 64-bit, no existe dicha limitación. Puede usar ASRock XFast RAM para utilizar la memoria que no puede usar Windows®.
4. Además, solamente la ranura PCIE1 admite la velocidad Gen 3. Para conseguir que PCI Express funcione a una velocidad Gen 3, debe instalar la CPU Ivy Bridge. Si instala la CPU Sandy Bridge, PCI Express solamente funcionará a velocidad PCI Express Gen 2.
5. El tamaño de la memoria compartido máximo es definido por el vendedor del chipset y está conforme al cambio. Por favor compruebe el Web site de Intel® para la información más última.
6. Puede elegir entre dos de los tres monitores solamente. Los monitores D-Sub, DVI-D y HDMI no se pueden habilitar al mismo tiempo. Además, con el adaptador DVI a HDMI, el puerto DVI-D puede admitir las mismas funciones que el puerto HDMI.
7. Las funciones xvYCC y Deep Color solamente se admiten con el sistema operativo Windows® 7 de 64 bits/ 7. El modo Deep Color solamente se habilitará si la pantalla admite 12 bpc en EDID. HBR se admite en Windows® 7 64 bits / 7 / Vista™ 64 bits / Vista™.
8. Para la entrada de micrófono, esta placa madre ofrece soporte para modos estéreo y mono. Para salida de audio, esta placa madre ofrece soporte para modos de 2 canales, 4 canales, 6 canales y 8 canales. Consulte la tabla en la página 3 para una conexión correcta.

Español

9. ASRock Extreme Tuning Utility (AXTU) es una herramienta todo en uno que permite realizar ajustes precisos en diferentes funciones del sistema mediante una interfaz sencilla, que incluye supervisión de hardware, control de ventiladores, función de aumento de la velocidad del reloj, DNA OC y IES. La función de supervisión de hardware, muestra las principales lecturas del sistema. La función de control de los ventiladores, muestra la velocidad y la temperatura de los ventiladores y permite ajustarlas. La función de aumento de la velocidad del reloj, permite aumentar la frecuencia de la CPU para conseguir un rendimiento óptimo del sistema. La función DNA OC permite guardar la configuración OC como un perfil y compartirla con sus amigos. Después, sus amistados pueden cargar el perfil OC en sus propios sistemas para obtener la misma configuración OC. En el protector de energía inteligente (IES, Intelligent Energy Saver), el regulador de voltaje puede reducir el número de fases de salida para mejorar la eficiencia cuando los núcleos de la CPU están inactivos sin que el rendimiento de cálculo disminuya. Visite nuestro sitio Web para obtener los procedimientos de funcionamiento de ASRock Extreme Tuning Utility (AXTU).
Sitio Web de ASRock: <http://www.asrock.com>
10. ASRock Instant Flash es una utilidad de programación del BIOS que se encuentra almacenada en la memoria Flash ROM. Esta sencilla herramienta de actualización de BIOS le permitirá actualizar el BIOS del sistema sin necesidad de acceder a ningún sistema operativo, como MS-DOS o Windows®. Gracias a esta utilidad, sólo necesitará pulsar <F6> durante la fase POST o pulsar <F2> para acceder al menú de configuración del BIOS y a la utilidad ASRock Instant Flash. Ejecute esta herramienta y guarde el archivo correspondiente al sistema BIOS nuevo en su unidad flash USB, unidad de disco flexible o disco duro para poder actualizar el BIOS con sólo pulsar un par de botones, sin necesidad de preparar un disco flexible adicional ni utilizar complicadas utilidades de programación. Recuerde que la unidad flash USB o disco duro utilizado debe disponer del sistema de archivos FAT32/16/12.
11. Si desea una forma más rápida y menos limitada de cargar sus dispositivos de Apple; como por ejemplo iPhone, iPad o iPod Touch, ASRock ha creado una fantástica solución para usted: ASRock APP Charger. Simplemente mediante la instalación del controlador de APP Charger, podrá cargar su iPhone de forma mucho más rápida que antes, hasta un 40%, desde su equipo. ASRock APP Charger le permite cargar de forma rápida muchos dispositivos de Apple simultáneamente e incluso podrá continuar la carga cuando su PC entre en modo de espera (S1), suspendido en RAM (S3), modo de hibernación (S4) o se apague (S5). Una vez instalado el controlador de APP Charger, podrá disfrutar fácilmente de una fantástica carga sin precedentes.
Sitio web de ASRock: <http://www.asrock.com/Feature/AppCharger/index.asp>

12. SmartView, una nueva función del explorador de Internet, es la página de inicio inteligente para IE que combina los sitios Web más visitados, su historial, sus amigos de Facebook y su fuente de noticias en una vista mejorada para disfrutar de una experiencia en Internet más personal. Las placas base ASRock están exclusivamente equipadas con la utilidad SmartView que le ayuda a seguir en contacto con sus amigos sobre la marcha. Para utilizar la función SmartView asegúrese de que la versión de su sistema operativo es Windows® 7 / 7 64 bits / Vista™ / Vista™ 64 bits y que la versión de su explorador es IE8. Sitio Web de ASRock: <http://www.asrock.com/Feature/SmartView/index.asp>
13. ASRock XFast USB puede aumentar el rendimiento de los dispositivos de almacenamiento USB. El rendimiento depende de las propiedades del dispositivo.
14. ASRock XFast LAN proporciona un acceso a Internet más rápido, que incluye las ventajas que se indican a continuación. Priorización de aplicaciones LAN: Puede configurar la prioridad de las aplicaciones de forma ideal y/o agregar nuevos programas. Menor latencia en los juegos: Después de aumentar la prioridad de los juegos en línea, se puede reducir la latencia en los mismos. Gestionar el tráfico: Puede ver vídeo en alta definición de Youtube y descargar archivos simultáneamente. Análisis de sus datos en tiempo real: Con la ventana de estado, puede reconocer fácilmente qué transmisiones en secuencias se están transfiriendo actualmente.
15. ASRock XFast RAM es una nueva función incluida en ASRock Extreme Tuning Utility (AXTU). Utiliza completamente el espacio de memoria que no se puede utilizar con procesadores de 32 bits en sistemas operativos Windows®. ASRock XFast RAM acorta el tiempo de carga de los sitios Web visitados con anterioridad, lo que permite navegar por Internet mucho más rápido que nunca. Además, también aumenta la velocidad de Adobe Photoshop 5 veces. Otra ventaja de ASRock XFast RAM es que reduce la frecuencia de acceso a las unidades de estado sólido (SSD) o las unidades de disco duro (HDD), lo que prolonga el período de vida útil de las mismas.
16. ASRock Crashless BIOS le permite a los usuarios actualizar su BIOS sin miedo de que ocurra un fallo. Si ocurre una interrupción en el suministro de energía durante el proceso de actualización del BIOS, ASRock Crashless BIOS finalizará de manera automática el proceso de actualización una vez se restablezca el suministro de energía. Tome en cuenta que los archivos del BIOS deben colocarse en el directorio raíz de su disco USB. Sólo los puertos USB 2.0 soportan esta función.
17. Los administradores pueden establecer cortes de acceso a Internet o acceso restringido a Internet en horarios especificados mediante OMG. Puede elegir entre las opciones [Diariamente], [Día de la semana] o [Entre semana y Fines de semana] y, a continuación, programar las horas de inicio y finalización del acceso a Internet concedido a otros usuarios. Para impedir que los usuarios no eviten OMG, se necesitan cuentas de invitado sin permiso para modificar la fecha y hora del sistema.

18. VIRTU Universal MVP incluye las funciones básicas de la tecnología Virtu Universal, que virtualiza la GPU integrada y la GPU discreta para obtener las mejores de las funcionalidades. También incluye Virtual Vsync™, que proporciona una calidad visual sin concesiones. Con las ventajas añadidas de la tecnología HyperFormance, VIRTU Universal MVP mejora el rendimiento de los juegos reduciendo inteligentemente las tareas de representación redundantes en el flujo entre la CPU, la GPU y la pantalla.
19. La tecnología de activación y desactivación de la reproducción de ASRock permite a los usuarios disfrutar de una excelente experiencia de audio de los dispositivos de audio portátiles, como por ejemplo reproductores MP3 o teléfonos móviles, en su PC, ¡incluso cuando su PC está apagado (o en el modo ACPI S5)! Esta placa base también proporciona un cable de audio de 3,5 mm (opcional) que garantiza a los usuarios el entorno de cálculo más práctico.
20. Aunque esta placa base ofrece un control completo, no es recomendable forzar la velocidad. Las frecuencias de bus de la CPU distintas a las recomendadas pueden causar inestabilidad en el sistema o dañar la CPU.
21. Cuando la temperatura de CPU está sobre-elevada, el sistema va a apagarse automáticamente. Antes de reanudar el sistema, compruebe si el ventilador de la CPU de la placa base funciona apropiadamente y desconecte el cable de alimentación, a continuación, vuelva a conectarlo. Para mejorar la disipación de calor, acuérdesese de aplicar thermal grease entre el procesador y el disipador de calor cuando usted instala el sistema de PC.
22. La opción de refrigeración combinada (C.C.O.) representa una opción flexible que puede adaptarse a tres tipos de disipador de CPU diferentes, correspondientes a los zócalos LGA 775, LGA 1155 y LGA 1156. Recuerde que no es posible el uso de todos los ventiladores para CPU 775 y 1156.
23. ASRock XFast RAM no se admite en Microsoft® Windows® XP y XP 64 bits. Intel® Smart Connect y Intel® puertos USB 3.0 no se admite en Microsoft® Windows® Vista™ / Vista™ 64 bits / XP / XP 64 bits.
24. EuP, siglas de Energy Using Product (Producto que Utiliza Energía), es una disposición regulada por la Unión Europea para establecer el consumo total de energía de un sistema. Según la disposición EuP, la alimentación de CA total para el sistema completo ha de ser inferior a 1,00W en modo apagado. Para cumplir con el estándar EuP, se requieren una placa base y una fuente de alimentación que cumplan con la directiva EuP. Según las directrices de Intel, una fuente de alimentación que cumpla con la directiva EuP debe satisfacer el estándar, es decir, la eficiencia de energía de 5v en modo de espera debería ser mayor del 50% con un consumo de corriente de 100mA. Para seleccionar una fuente de alimentación que cumpla la directiva EuP, le recomendamos que consulte con el fabricante de la fuente de alimentación para obtener más detalles.

1.3 Setup de Jumpers

La ilustración muestra como los jumpers son configurados. Cuando haya un jumper-cap sobre los pins, se dice que el jumper está "Short". No habiendo jumper cap sobre los pins, el jumper está "Open". La ilustración muestra un jumper de 3 pins cuyo pin 1 y pin 2 están "Short".

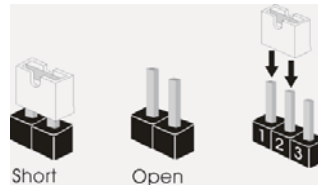

Jumper

Setting

Limpiar CMOS

(CLRCMOS1, jumper de 3 pins)
(ver p.2, N. 15)



Valor predeterminado



Restablecimiento de la CMOS

Nota: CLRCMOS1 permite borrar los datos de la memoria CMOS. Para borrar los parámetros del sistema y restablecer la configuración predeterminada de los mismos, apague el equipo y desenchufe el cable de alimentación de la toma de corriente eléctrica. Deje que transcurran 15 segundos y, después, utilice un puente para cortocircuitar los contactos 2 y 3 de CLRCMOS1 durante 5 segundos. No borre la memoria CMOS justamente después de actualizar el BIOS. Si necesita borrar la memoria CMOS justamente después de actualizar el BIOS, debe iniciar primero el sistema y, a continuación, cerrarlo antes de llevar a cabo el borrado de dicha memoria. Tenga en cuenta que la contraseña, la fecha, la hora, el perfil predeterminado del usuario, el GUID 1394 y la dirección MAC solamente se borrará si la batería CMOS se quita.

1.4 Cabezales y Conectores en Placas



Los conectores y cabezales en placa NO son puentes. NO coloque las cubiertas de los puentes sobre estos cabezales y conectores. El colocar cubiertas de puentes sobre los conectores y cabezales provocará un daño permanente en la placa base.

Conexiones de serie ATA2

(SATA2_2_3: vea p.2, N. 14)

(SATA2_4: vea p.2, N. 21)

(SATA2_5: vea p.2, N. 20)

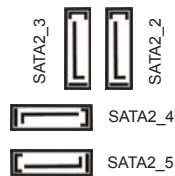

Estas cuatro conexiones de serie ATA2 (SATA2) admiten cables SATA para dispositivos de almacenamiento internos. La interfaz SATA2 actual permite una velocidad de transferencia de 3.0 Gb/s.

Conexiones de serie ATA3

(SATA3_A0_A1: vea p.2, N. 12)

(SATA3_0_1: vea p.2, N. 13)

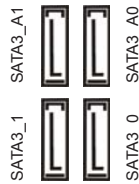

Estas cuatro conexiones de serie ATA3 (SATA3) admiten cables SATA para dispositivos de almacenamiento internos. La interfaz SATA2 / SATA3 actual permite una velocidad de transferencia de 6.0 Gb/s. Si el puerto eSATA3 situado en el panel de E/S posterior se ha conectado, el SATA3_A1 interno no funcionará.

Cable de datos de serie ATA (SATA)

(Opcional)



Cualquier extremo del cable de los datos de SATA puede ser conectado con el disco duro de SATA / SATA2 / SATA3 o el conector de SATA2 / SATA3 en esta placa base.

Cabecera de puerto de impresora

(LPT1 de 25 terminales)
(vea p.2, N. 28)

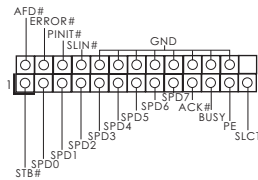

Esta es una interfaz de puerto para cable de impresora que permite conectar cómodamente dispositivos de impresión.

Cabezal USB 2.0

(9-pin USB_6_7)
(vea p.2, N. 25)

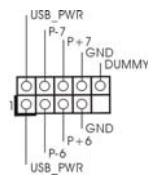

(9-pin USB_8_9)
(vea p.2, N. 24)

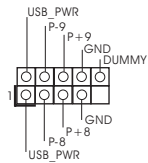

(9-pin USB_10_11)
(vea p.2, N. 23)

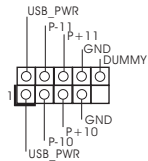

Además de cuatro puertos USB 2.0 predeterminados en el panel de E/S, hay tres bases de conexiones USB 2.0 en esta placa base. Cada una de estas bases de conexiones admite dos puertos USB 2.0.

Cabezal USB 3.0

(19-pin USB3_12_13)
(vea p.2, N. 9)

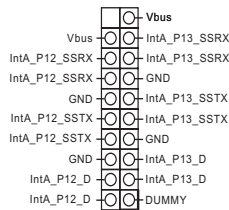

Además de cuatro puertos 3.0 predeterminados situados en el panel E/S, encontrará una cabecera USB 3.0 en esta placa base. Esta cabecera USB 3.0 admiten dos puertos USB 3.0.

Cabezal de Módulo Infrarrojos

(5-pin IR1)
(vea p.2, N. 19)

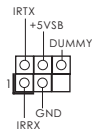

Este cabezal soporta un módulo infrarrojos de transmisión y recepción wireless opcional.

Español

Base de conexiones del módulo de infrarrojos para el consumidor

(4-pin CIR1)
(vea p.2, N. 26)



Esta base de conexiones se puede utilizar para conectar receptor remoto.

Conector de audio de panel frontal

(9-pin HD_AUDIO1)
(vea p.2, N. 33)

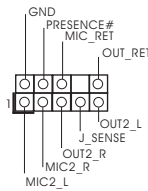

Este es una interface para cable de audio de panel frontal que permite conexión y control conveniente de aparatos de Audio.



1. El Audio de Alta Definición soporta la detección de conector, pero el cable de panel en el chasis debe soportar HDA para operar correctamente. Por favor, siga las instrucciones en nuestro manual y en el manual de chasis para instalar su sistema.
2. Si utiliza el panel de sonido AC'97, instálelo en la cabecera de sonido del panel frontal de la siguiente manera:
 - A. Conecte Mic_IN (MIC) a MIC2_L.
 - B. Conecte Audio_R (RIN) a OUT2_R y Audio_L (LIN) en OUT2_L.
 - C. Conecte Ground (GND) a Ground (GND).
 - D. MIC_RET y OUT_RET son sólo para el panel de sonido HD. No necesitará conectarlos al panel de sonido AC'97.
 - E. Activación del micrófono frontal.

En sistemas operativos Windows® XP / XP 64-bit:
Seleccione "Mixer" (Mezclador). Seleccione "Recorder" (Grabadora). A continuación, haga clic en "FrontMic" (Micrófono frontal).

En sistemas operativos Windows® 7 / 7 64-bit / Vista™ / Vista™ 64-bit:
Acceda a la ficha "FrontMic" (Micrófono frontal) del panel de control Realtek. Ajuste la posición del control deslizante "Recording Volume" (Volumen de grabación).

Cabezal de panel de sistema

(9-pin PANEL1)
(vea p.2, N. 18)

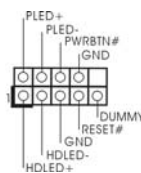

Este cabezar acomoda varias dunciones de panel frontal de sistema.



Conecte el interruptor de alimentación, el interruptor de restablecimiento y el indicador de estado del sistema situados en el chasis con esta cabecera en función de las siguientes asignaciones de contacto. Preste atención a los contactos positivos y negativos antes de conectar los cables.

PWRBTN (interruptor de alimentación):

Conecte el interruptor de encendido situado en el panel frontal del chasis. Puede configurar la forma de apagar su sistema mediante el interruptor de alimentación.

RESTABLECER (interruptor de restablecimiento):

Conecte el interruptor de restablecimiento situado en el panel frontal del chasis. Pulse el interruptor de restablecimiento para restablecer el equipo si se bloquea y no se reinicia con normalidad.

PLED (LED de alimentación del sistema):

Conecte el indicador de estado de alimentación situado en el panel frontal del chasis. El LED se enciende cuando el sistema esté en funcionamiento. El LED parpadea cuando el sistema se encuentre en estado de suspensión S1/S3. El LED se apaga cuando el sistema se encuentre en estado de suspensión S4 o se apaga (S5).

HDLED (LED de actividad del disco duro):

Conecte el LED de actividad de disco duro situado en el panel frontal del chasis. El LED se enciende cuando el disco duro esté leyendo o escribiendo datos.

Es posible que el diseño del panel frontal varíe en función del chasis. Un módulo del panel frontal consiste principalmente de interruptor de alimentación, interruptor de restablecimiento, LED de alimentación, LED de actividad del disco duro, altavoz, etc. Al conectar el módulo del panel frontal del chasis a esta cabecera, asegúrese de que las asignaciones de cables y las asignaciones de contactos coincidan correctamente.

Cabezal del altavoz del chasis
(4-pin SPEAKER1)
(vea p.2, N. 16)

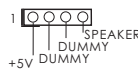

Conecte el altavoz del chasis a su cabezal.

Cabecera de indicador LED de encendido

(3-pin PLED1)

(vea p.2, N. 17)



Conecte el indicador LED de encendido del chasis a esta cabecera para conocer el estado de encendido del sistema. El indicador LED se encenderá si el sistema se encuentra en funcionamiento. El indicador LED parpadeará en el estado S1/S3. El indicador LED se apagará en los estados S4 o S5 (apagado).

Conectores de ventilador de chasis / alimentación

(4-pin CHA_FAN1)

(vea p.2, N. 22)



(3-pin CHA_FAN2)

(vea p.2, N. 35)

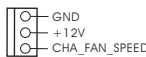

(3-pin PWR_FAN1)

(vea p.2, N. 2)

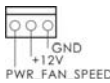

Por favor, conecte los cables del ventilador a los conectores de ventilador, haciendo coincidir el cable negro con la patilla de masa. CHA_FAN1 y CHA_FAN2 admiten control de ventilador.

Conector del ventilador de la CPU

(4-pin CPU_FAN1)

(vea p.2, N. 3)

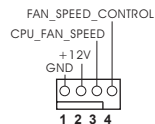

Conecte el cable del ventilador de la CPU a este conector y haga coincidir el cable negro con el conector de tierra.



Aunque esta placa base proporciona compatibilidad para un ventilador (silencioso) de procesador de 4 contactos, el ventilador de procesador de 3 contactos seguirá funcionando correctamente incluso sin la función de control de velocidad de ventilador. Si pretende enchufar el ventilador de procesador de 3 contactos en el conector del ventilador de procesador de esta placa base, conéctelo al contacto 1-3.

Contacto 1-3 conectado ←

Instalación del ventilador de 3 contactos

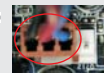

(3-pin CPU_FAN2)

(vea p.2, N. 1)

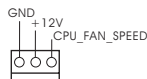

Cabezal de alimentación ATX
(24-pin ATXPWR1)
(vea p.2, N. 8)

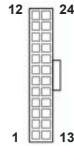

Conecte la fuente de alimentación ATX a su cabezal.



A pesar de que esta placa base incluye un conector de alimentación ATX de 24 pins, ésta puede funcionar incluso si utiliza una fuente de alimentación ATX de 20 pins tradicional. Para usar una fuente de alimentación ATX de 20 pins, por favor, conecte su fuente de alimentación usando los Pins 1 y 13.

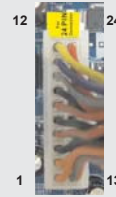

Instalación de una Fuente de Alimentación ATX de 20 Pins

Cabezal de alimentación ATX 12V
(8-pin ATX12V1)
(vea p.2, N. 4)



Conecte la fuente de alimentación ATX 12V a su cabezal.



Aunque esta placa base proporciona un conector de energía de 8-pin ATX 12V, puede todavía trabajar si usted adopta un fuente tradicional de energía de 4-pin ATX 12V. Para usar el fuente de energía de 4-pin ATX 12V, por favor conecte su fuente de energía junto con Pin 1 y Pin 5.



Instalación de Fuente de Energía de 4-Pin ATX 12V

Cabezal del puerto COM
(9-pin COM1)
(vea p.2, N. 27)

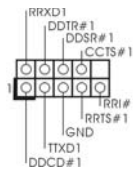

Este cabezal del puerto COM se utiliza para admitir un módulo de puerto COM.

Cabecera HDMI_SPDIF
(HDMI_SPDIF1 de 2 pin)
(vea p.2, N. 34)



Cabecera HDMI_SPDIF. Ofrece una salida SPDIF la tarjeta VGA HDMI, permite al sistema conectarse a dispositivos de TV Digital HDMI / proyectores / Dispositivos LCD. Conecte el conector HDMI_SPDIF de la tarjeta VGA HDMI a esta cabecera.

2. BIOS Información

El Flash Memory de la placa madre deposita SETUP Utility. Durante el Power-Up (POST) apriete <F2> o para entrar en la BIOS. Si usted no oprime ninguna tecla, el POST continúa con sus rutinas de prueba. Si usted desea entrar en la BIOS después del POST, por favor reinicie el sistema apretando <Ctl> + <Alt> + <Borrar>, o apretando el botón Reset en el panel del ordenador. Para información detallada sobre como configurar la BIOS, por favor refiérase al Manual del Usuario (archivo PDF) contenido en el CD.

3. Información de Software Support CD

Esta placa-base soporta diversos tipos de sistema operativo Windows®: 7 / 7 64 bits / Vista™ / Vista™ 64 bits / XP / XP 64 bits. El CD de instalación que acompaña la placa-base trae todos los drivers y programas utilitarios para instalar y configurar la placa-base. Para iniciar la instalación, ponga el CD en el lector de CD y se desplegará el Menú Principal automáticamente si «AUTORUN» está habilitado en su computadora.

Si el Menú Principal no aparece automáticamente, localice y doble-pulse en el archivo "ASSETUP.EXE" para iniciar la instalación.

1. Введение

Благодарим вас за покупку материнской платы ASRock **Z77 Pro4-M** надежной материнской платы, изготовленной в соответствии с постоянно предъявляемыми ASRock жесткими требованиями к качеству. Она обеспечивает превосходную производительность и отличается отличной конструкцией, которые отражают приверженность ASRock качеству и долговечности.

Данное руководство по быстрой установке включает вводную информацию о материнской плате и пошаговые инструкции по ее установке. Более подробные сведения о плате можно найти в руководстве пользователя на компакт-диске поддержки.



Спецификации материнской платы и программное обеспечение BIOS иногда изменяются, поэтому содержание этого руководства может обновляться без уведомления. В случае любых модификаций руководства его новая версия будет размещена на веб-сайте ASRock без специального уведомления. Кроме того, самые свежие списки поддерживаемых модулей памяти и процессоров можно найти на сайте ASRock.

Адрес веб-сайта ASRock <http://www.asrock.com>

При необходимости технической поддержки по вопросам данной материнской платы посетите наш веб-сайт для получения информации об используемой модели.

www.asrock.com/support/index.asp

1.1 Комплектность

Материнская плата ASRock **Z77 Pro4-M**

(форм-фактор Micro ATX: 9,6 x 9,6 дюйма / 24,4 x 24,4 см)

Руководство по быстрой установке ASRock **Z77 Pro4-M**

Компакт-диск поддержки ASRock **Z77 Pro4-M**

2 x кабель данных Serial ATA (SATA) (дополнительно)

1 x I/O Щит Группы ввода / вывода



ASRock напоминает...

Для обеспечения максимальной производительности ОС Windows® 7 / 7 64-bit / Vista™ / Vista™ 64-bit рекомендуется в BIOS выбрать для параметра Storage Configuration (Конфигурация запоминающего устройства) режим AHCI. Подробные сведения о настройке BIOS см. в руководстве пользователя на прилагаемом компакт-диске.

1.2 Спецификации

Платформа	<ul style="list-style-type: none"> - форм-фактор Micro ATX: 9,6 x 9,6 дюйма / 24,4 x 24,4 см - Весь Твердый Конденсаторный проект (100% японские высококачественные конденсаторы на основе проводящих полимеров)
Процессор	<ul style="list-style-type: none"> - Поддержка процессора Intel® Core™ i7 / i5 / i3 3-го и 2-го поколения с помощью разъема для процессоров LGA 1155 - Дизайн системы питания DigiPower - 4 + 2 проектирование фаз питания - Поддержка технологии Intel® Turbo Boost 2.0 - Поддержка разблокированного ЦП серии K - Поддержка технологии Hyper-Threading (см. ОСТОРОЖНО, пункт 1) - Поддержка технологии Intel® Rapid Start Technology и Smart Connect Technology с помощью процессора Intel® Ivy Bridge
Набор микросхем	- Intel® Z77
Память	<ul style="list-style-type: none"> - Поддержка технологии Dual Channel DDR3 Memory Technology (см. ОСТОРОЖНО, пункт 2) - 4 x гнезда DDR3 DIMM - Поддержите DDR3 2800+(OC)/2400(OC)/2133(OC)/1866(OC)/1600/1333/1066 не- ECC, безбуферная память - Максимальный объем системной памяти: 32 ГБ (см. ОСТОРОЖНО, пункт 3) - поддержка профиля Intel® Extreme Memory Profile (XMP)1.3/1.2
Гнезда расширения	<ul style="list-style-type: none"> - 1 x слота PCI Express 3.0 x16 (PCIЕ1: режим x16) (см. ОСТОРОЖНО, пункт 4) * PCIЕ 3.0 поставляется только в комплекте с ЦП Intel® Ivy Bridge. В комплекте с ЦП Intel® Sandy Bridge поставляется только модель PCIЕ 2.0. - 2 x гнезда PCI Express 2.0 x16 (PCIЕ3: режим x1; PCIЕ4: режим x4) - 1 x гнезда PCI Express 2.0 x1 - поддержка AMD Quad CrossFireX™ и CrossFireX™
Графика	<ul style="list-style-type: none"> * Встроенный видеоадаптер Intel® HD Graphics и выходы VGA поддерживаются только с процессорами, оснащенными интегрированным графическим процессором. - Поддержка функций встроенных видеоадаптеров Intel® HD: Intel® Quick Sync Video 2.0, Intel® InTru™ 3D, технологии Intel® Clear Video HD, Intel® Insider™, Intel® HD Graphics 2500/4000 - Pixel Shader 5.0, DirectX 11 с процессором Intel® Ivy Bridge, Pixel Shader 4.1, DirectX 10.1 с процессором Intel® Sandy Bridge - Макс. объем разделяемой памяти 1760Мб (см. ОСТОРОЖНО, пункт 5) - три VGA-выхода: D-Sub, DVI-D и HDMI (см. ОСТОРОЖНО, пункт 6) - Поддержка HDMI 1.4a с максимальным разрешением до 1920x1200 @ 60 Гц - Поддержка DVI с максимальным разрешением до 1920x1200 @ 60 Гц

	<ul style="list-style-type: none"> - Поддержка D-Sub с максимальным разрешением до 2048x1536 @ 75 Гц - Поддержка Auto Lip Sync, Deep Color (12 бит на цветовой канал), xvYCC и HBR (High Bit Rate Audio) через HDMI (необходим монитор с разъемом HDMI) (см. ОСТОРОЖНО, пункт 7) - Поддержка функции HDCP через разъемы DVI и HDMI - Поддержат Blu-луч 1080p (КОММУТАЦИОННАЯ ДОСКА) / воспроизведение HD-DVD через разъемы DVI и HDMI
Аудиосистема	<ul style="list-style-type: none"> - 7.1 CH HD Аудио HD с Довольной Защитой (Кодер-декодер Аудио Realtek ALC892) - Поддержка Premium Blu-ray audio - Поддержка технологии THX TruStudio™
ЛВС	<ul style="list-style-type: none"> - PCIЕ x 1 Gigabit LAN 10/100/1000 Mb/s - Realtek RTL8111E - поддержка Wake-On-LAN - Поддержка определения кабеля ЛВС - Поддержка энергосберегающего интерфейса Ethernet 802.3az - Поддержка PXE
Разъемы ввода-вывода на задней панели	<p>I/O Panel</p> <ul style="list-style-type: none"> - 1 x порт клавиатуры PS/2 - 1 x D-Sub порт - 1 x DVI-D порт - 1 x HDMI порт - 1 x порт Optical SPDIF Out - 4 x порта USB 2.0 на задней панели в стандартной конфигурации - 1 x eSATA3 порт - 2 x порта USB 3.0 на задней панели в стандартной конфигурации - 1 x Разъем RJ-45 LAN с светодиодным индикатором (индикатор ACT/LINK и индикатор SPEED) - Соединитель звуковой подсистемы: тыльная колонка / центральная / суббуфер / линейный вход / передняя колонка / микрофон (см. ПРЕДУПРЕЖДЕНИЕ 8)
SATA3	<ul style="list-style-type: none"> - 2 x порта SATA3 со скоростью передачи данных 6,0 Гбит/с от контроллера Intel® Z77, с аппаратной поддержкой функций RAID (RAID 0, RAID 1, RAID 5, RAID 10, Intel Rapid Storage и технологии Intel Smart Response), NCQ, AHCI и горячего подключения - 2 x порта SATA3 со скоростью передачи данных 6,0 Гбит/с от контроллера ASMedia ASM1061, с аппаратной поддержкой функций NCQ, AHCI и «горячего подключения» (порт SATA3_A1 объединен с портом eSATA3)
USB 3.0	<ul style="list-style-type: none"> - 2 x задних порта USB 3.0 на контроллере с поддержкой интерфейсов USB 1.0/2.0/3.0 и скорости передачи данных до 5 Гбит/с - 1 x передний разъем USB 3.0 (поддерживает 2 порта USB 3.0) с поддержкой интерфейсов USB 1.0/2.0/3.0 и скорости передачи данных до 5 Гбит/с
Колодки и плате	<ul style="list-style-type: none"> - 4 x разъема SATA2 3,0 Гбит/с, поддержка функций RAID (RAID 0, RAID 1, RAID 5, RAID 10, Intel Rapid Storage и технологии Intel

	<ul style="list-style-type: none"> Smart Response), NCQ, AHCI и горячего подключения - 4 x разъема SATA3 6,0 Гбит/с - 1 x Колодка инфракрасного модуля - 1 x Датчик пользовательского инфракрасного модуля - 1 x Разъем порта печати - 1 x Колодка COM - 1 x Колодка HDMI_SPDIF - 1 x разъем Power LED - соединитель: CPU/Chassis/Power FAN - 24-контактный Колодка питания ATX - 8-контактный Разъем ATX 12 В - Аудиоразъем передней панели - 3 x Колодка USB 2.0 (одна колодка для поддержки 6) дополнительных портов USB 2.0 - 1 x Колодка USB 3.0 (одна колодка для поддержки 2 дополнительных портов USB 3.0)
BIOS	<ul style="list-style-type: none"> - 64Mb AMI UEFI Legal BIOS с поддержкой графического интерфейса поль зователя - поддержка "Plug and Play" - ACPI 1.1, включение по событиям - поддержка режима настройки без перемычек - поддержка SMBIOS 2.3.1 - Регулировка напряжений CPU Core, IGPU, DRAM, 1.8V PLL, VTT, VCCSA
Компакт- диск поддержки	<ul style="list-style-type: none"> - Драйверы, служебные программы, антивирусное программное обеспечение (пробная версия), Пробная версия программы CyberLink MediaEspresso 6.5, ASRock MAGIX Multimedia Suite - поставщик
Уникальная особенность	<ul style="list-style-type: none"> - Средство ASRock Extreme Tuning Utility (AXTU) (см. ОСТОРОЖНО, пункт 9) - ASRock Instant Boot - ASRock Instant Flash (см. ОСТОРОЖНО, пункт 10) - ASRock APP Charger (см. ОСТОРОЖНО, пункт 11) - ASRock SmartView (см. ОСТОРОЖНО, пункт 12) - ASRock XFast USB (см. ОСТОРОЖНО, пункт 13) - ASRock XFast LAN (см. ОСТОРОЖНО, пункт 14) - ASRock XFast RAM (см. ОСТОРОЖНО, пункт 15) - ASRock Crashless BIOS (см. ОСТОРОЖНО, пункт 16) - ASRock OMG (Online Management Guard) (см. ОСТОРОЖНО, пункт 17) - Lucid Virtu Universal MVP (см. ОСТОРОЖНО, пункт 18) * Lucid Virtu Universal MVP поддерживается только с процессорами, оснащенными интегрированными интегрированным графическим процессором. - Технология ASRock для воспроизведения звука во включенном и выключенном состоянии (см. ОСТОРОЖНО, пункт 19) - Hybrid Booster: <ul style="list-style-type: none"> - плавная настройка частоты процессора

	(см. ОСТОРОЖНО, пункт 20) - ASRock U-COP (см. ОСТОРОЖНО, пункт 21) - Защита от сбоев загрузки Boot Failure Guard (B.F.G.) - Combo Cooler Option (C.C.O.) (см. ОСТОРОЖНО, пункт 22) - Ночное LED-освещение
Контроль оборудования	- Датчики температуры процессора - Датчики температуры корпуса - Тахометры вентиляторов CPU/Chassis/Power FAN - Бесшумный вентилятор ЦП/системного блока (возможность автоматической настройки скорости вентилятора системного блока в соответствии с температурой центрального процессора) - Мультиконтроль скорости вентилятора ЦП/Шасси - Контроль напряжения: +12V, +5V, +3.3V, Vcore
Операционные системы	- Совместимость с Microsoft® Windows® 7 / 7 64-bit / Vista™ / Поддержка 64-разрядной версии Vista™ / XP / XP 64-bit (см. ОСТОРОЖНО, пункт 23)
Сертификаты	- FCC, CE, WHQL - Совместимость с E9P/EuP Ready (требуется блок питания совместимый с E9P/EuP) (см. ОСТОРОЖНО, пункт 24)

* Для детальной информации продукта, пожалуйста посетите наш вебсайт:
<http://www.asrock.com>

ВНИМАНИЕ

Следует понимать, что с оверклокингом связан определенный риск во всех случаях, включая изменение установок BIOS, применение технологии Untied Overclocking или использование инструментов оверклокинга сторонних производителей. Оверклокинг может повлиять на стабильность работы системы и даже вызвать повреждение входящих в нее компонентов и устройств. Приступая к оверклокингу, вы полностью берете на себя все связанные с ним риски и расходы. Мы не будем нести ответственность за любые возможные повреждения в результате оверклокинга.

ОСТОРОЖНО!

1. Информацию об установке параметров гиперпоточной технологии (Hyper-Threading Technology) вы найдете на стр. 52 Руководства пользователя на компакт-диске поддержки.
2. Данная материнская плата поддерживает технологию двухканальной памяти Dual Channel Memory Technology. Перед ее использованием не забудьте прочитать инструкции по правильной установке модулей памяти в руководстве по установке (стр. 17).
3. В силу ограничения операционной системы фактическая емкость памяти может быть меньше 4Гб для обеспечения резервного места для использования системой Windows® 7 / Vista™ / XP. Таких ограничений нет для Windows® OS с 64-bit центральным процессором. Технология ASRock XFast RAM помогает использовать память, которая не используется ОС Windows®.

4. Только PCIe1 поддерживает скорость Gen 3. Для работы PCI Express на скорости Gen 3 обязательно установите ЦП Ivy Bridge. При установке ЦП Sandy Bridge работа PCI Express осуществляется только на скорости PCI Express Gen 2.
5. Максимальная совместная емкость памяти определена продавцом микропроцессорного набора и может измениться. Входите в Intel® веб-сайт за последние информации, пожалуйста.
6. Вы можете использовать только два разъема из трех для вывода изображения одновременно. Задействовать сразу три подключения - D-Sub, DVI-D и HDMI - невозможно. При помощи адаптера DVI-to-HDMI порт DVI-D будет поддерживать те же функции, что и HDMI.
7. Функции xVCC и Deep Color поддерживаются только в Windows® 7 64-бит / 7. Функция Deep Color будет включена только в том случае, если монитор поддерживает функцию EDID (12-битные цветовые каналы). Функция HBR поддерживается только в Windows® 7 64-бит / 7 / Vista™ 64-бит / Vista™.
8. Поддерживается работа микрофонного входа в режимах моно и стерео. Поддерживаются 2-, 4-, 6- и 8-канальный режимы вывода звука. Соответствующие схемы подключения описаны на стр. 3.
9. Служебная программа ASRock Extreme Tuning Utility (AXTU) – это универсальное средство тонкой настройки различных функций системы с удобным и понятным интерфейсом, включающая разделы Hardware Monitor (Наблюдение за оборудованием), Fan Control (Управление вентилятором), Overclocking («Разгон» процессора), OC DNA (Параметры «разгона») and IES (Автоматическое энергосбережение). В разделе Hardware Monitor (Наблюдение за оборудованием) отображаются основные характеристики аппаратных средств системы. В разделе Fan Control (Управление вентилятором) отображается скорость вентилятора и температура, которые можно регулировать. В разделе Overclocking («Разгон» процессора) можно увеличить рабочую частоту ЦПУ, чтобы добиться оптимальной производительности системы. В разделе OC DNA (Параметры «разгона») можно сохранить настройки «разгона» процессора в виде профиля, который потом можно предложить для использования своим друзьям. Друзья смогут загрузить профиль «разгона» на свои компьютеры и получить аналогичный результат. В разделе IES (Автоматическое энергосбережение) можно настроить регулятор напряжения так, что он будет уменьшать количество работающих линий питания, чтобы поднять КПД системы без ущерба для ее производительности во время простоя ядер ЦПУ. Чтобы узнать, как работать с программой ASRock Extreme Tuning Utility (AXTU), посетите наш сайт в Интернете. Адрес сайта ASRock: <http://www.asrock.com>
10. ASRock Instant Flash – программа для прошивки BIOS, встроенная в Flash ROM. Данное средство для обновления BIOS умеет работать без входа в операционные системы, вроде MS-DOS или Windows®. Чтобы запустить программу достаточно нажать <F6> во время самотестирования системы (POST) или войти в BIOS при помощи кнопки <F2> и выбрать пункт ASRock Instant Flash через меню. Запустите программу и сохраните

новый BIOS на USB-флэшку, дискету или жесткий диск. После этого вы сможете оперативно обновить BIOS, без необходимости подготовки дополнительной дискеты, без установки программы прошивки. Имейте в виду, что USB-флэшка или винчестер должны использовать файловую систему FAT32/16/12.

11. Если вы хотите быстрее и без ограничений заряжать свои устройства Apple, например iPhone, iPad и iPod Touch, компания ASRock приготовила отличное решение для вас – ASRock APP Charger. Просто установив драйвер APP Charger, вы сможете заряжать iPhone от компьютера намного быстрее, ускорение составит до 40%. ASRock APP Charger позволяет быстро заряжать несколько устройств Apple одновременно и даже поддерживает непрерывную зарядку, когда компьютер переходит в режим ожидания (S1), режим ожидания с сохранением данных в ОЗУ (S3), режим гибернации (S4) или режим выключения (S5). Установив драйвер APP Charger, вы испытаете небывалое удобство зарядки.
Веб-сайт ASRock: <http://www.asrock.com/Feature/AppCharger/index.asp>
12. SmartView — это интеллектуальная стартовая страница для браузера IE, на которой отображаются наиболее посещаемые веб-сайты, история посещений, друзья в Facebook и обновляемые потоки новостей. Эта новая функция обеспечивает более удобное использование возможностей Интернета. Системные платы ASRock эксклюзивно снабжаются программой SmartView, помогающей поддерживать связь с друзьями. Программа SmartView работает в ОС Windows® 7 / 7 64 bit / Vista™ / Vista™ 64 bit и браузере IE8.
Веб-сайт ASRock: <http://www.asrock.com/Feature/SmartView/index.asp>
13. Функция ASRock XFast USB увеличивает скорость работы устройств USB. Рост скорости зависит от устройства.
14. ASRock XFast LAN обеспечивает более быстрый доступ к сети Интернет, который даст описанные далее преимущества. Установка приоритетов приложений ЛВС: можно задать оптимальный приоритет для своего приложения и/или добавить новые программы. Более низкая латентность в игре: после установки более высокого приоритета игре в режиме онлайн, может снизиться латентность в игре. Формирование трафика: можно одновременно просматривать видео высокого разрешения на Youtube и загружать файлы. Анализ данных в реальном времени: в окне состояния можно легко определить, какие потоки данных передаются в данный момент времени.
15. ASRock XFast RAM – новая функция, входящая в состав утилиты ASRock Extreme Tuning Utility (AXTU). Благодаря ей, используется область памяти, использование которой не возможно на процессоре с 32-битной ОС Windows®. ASRock XFast RAM сокращает время загрузки истории посещения веб-сайтов, существенно ускоряя навигацию по сети Интернет. Кроме того, скорость работы Adobe Photoshop 5 увеличивается в пять раз. В числе преимуществ ASRock XFast RAM - сокращение частоты обращений к SSD-накопителям и жестким дискам и продление срока их эксплуатации.

16. ASRock Crashless BIOS позволяет пользователям обновлять BIOS, не боясь отказа. В случае отключения электроэнергии в процессе обновления BIOS ASRock Crashless BIOS автоматически завершает процедуру обновления BIOS после возобновления подачи энергии. Обратите внимание на то, что BIOS размещается в корневом каталоге вашего USB диска. Данная функция доступна только для портов USB2.0.
17. Администраторы могут установить «комендантский час» или ограничить доступ к Интернету в определенное время с помощью OMG. Можно выбрать [Ежедневно], [День недели] или [Будни и выходные дни], затем указать время начала и окончания интернет-доступа для других пользователей. Чтобы не допустить обхода пользователями системы OMG, необходимы учетные записи гостей без разрешения на модификацию системного времени.
18. Пакет VIRTU Universal MVP включает базовые возможности технологии Virtu Universal, которая виртуализирует интегрированный и дискретный графические процессоры для достижения лучших среди аналогов функциональных характеристик. Это характеризует и Virtual Vsync™, благодаря бескомпромиссному качеству видеоизображения. Благодаря дополнительным преимуществам технологии HyperFormance technology, VIRTU Universal MVP улучшает качество работы видеоигр, грамотно сокращая количество ненужных задач по визуализации изображения в потоке между центральным процессором, графическим процессором и монитором.
19. Технология ASRock для воспроизведения звука во включенном и выключенном состоянии позволяет пользователям портативных аудиоустройств, таких как MP3-плееры и мобильные телефоны, прослушивать с них высококачественный звук через компьютер, даже когда компьютер выключен (или находится в режиме ACPI S5)! Кроме того, к данной материнской плате бесплатно (дополнительно) прилагается аудиокабель с 3,5-мм штекерами, который обеспечивает наиболее удобное подключение аудиоустройств к компьютеру.
20. Хотя данная материнская плата поддерживает плавную настройку частоты, устанавливать повышенную частоту не рекомендуется. Использование значений частоты шины процессора отличающихся от рекомендованных, может привести к нестабильной работе системы или повреждению процессора и материнской платы.
21. При обнаружении перегрева процессора работа системы автоматически завершается. Прежде чем возобновить работу системы, убедитесь в нормальной работе вентилятора процессора на материнской плате и отсоедините шнур питания, а затем снова подключите его. Чтобы улучшить отвод тепла, не забудьте при сборке компьютера нанести термопасту между процессором и радиатором.
22. Combo Cooler Option (C.C.O.) предоставляет возможность устанавливать разные типы процессорных кулеров на материнскую плату – под Socket LGA775, LGA1155 или LGA1156. Внимание, не все кулеры под LGA775 или LGA1156 можно использовать.

23. ОС Microsoft® Windows® XP / XP 64-разрядной версией, не поддерживает ASRock XFast RAM. ОС Microsoft® Windows® Vista™ / 64-разрядной версии Vista™ / XP / XP 64-bit, не поддерживает Intel® Smart Connect Technology и Intel® порта USB 3.0.
24. EuP расшифровывается как Energy Using Product. Стандарт был разработан Европейским Союзом для определения энергопотребления готовых систем. По требованию EuP система в выключенном состоянии должна потреблять менее 1 Вт энергии. Для соответствия стандарту EuP нужны соответствующие материнская плата и блок питания. Компания Intel предложила, что совместимый с EuP блок питания должен обеспечивать 50% эффективность линии питания 5V при потреблении 100 мА (в режиме ожидания). Сверьтесь с информацией производителей блоков питания, чтобы выбрать модель с поддержкой EuP.

1.3 Установка переключателя

Конфигурация переключателя иллюстрируется на рисунке. Когда переключатель надет на контакты, они называются “замкнутыми” (short). Если на контактах переключателя нет, то они называются “разомкнутыми” (open). На иллюстрации показана 3-контактная переключатель, у которой контакты 1 и 2 замкнуты.

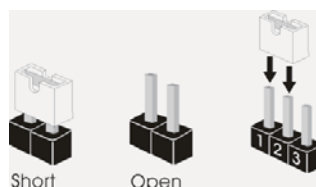

Переключатель	Установка	Описание
Очистка CMOS (CLRCMOS1, 3-контактная переключатель) (см. стр. 2, п. 15)	<div style="display: flex; justify-content: space-around;"> <div style="text-align: center;"> <p>1_2</p> <p>Стандартные</p> </div> <div style="text-align: center;"> <p>2_3</p> <p>Очистка CMOS</p> </div> </div>	

Примечание. Контактная колодка CLRCMOS1 позволяет очистить данные CMOS. Для очистки данных и восстановления заводских системных параметров сначала выключите компьютер и отсоедините сетевую вилку кабеля питания от электророзетки. Выждите не менее 15 секунд и колпачковой переключатель на 5 секунд переключите штырьки 2 и 3 контактной колодки CLRCMOS1. Однако не производите очистку CMOS непосредственно после обновления BIOS. Если необходимо очистить CMOS сразу же после окончания обновления BIOS, то, перед очисткой CMOS, необходимо сначала выполнить загрузку системы, а затем завершить ее работу. Примите во внимание, что пароль, дата, время, профиль пользователя по умолчанию, идентификатор 1394 GUID и MAC-адрес будут очищены только тогда, когда будет извлечена из своего гнезда батарейка CMOS.

1.4 Колодки и разъемы на плате



Имеющиеся на плате колодки и разъемы НЕ ЯВЛЯЮТСЯ контактами для перемычек. НЕ УСТАНОВЛИВАЙТЕ перемычки на эти колодки и разъемы – это приведет к необратимому повреждению материнской платы!

Разъемы Serial ATA2

(SATA2_2_3, см. стр. 2, п. 14)

(SATA2_4, см. стр. 2, п. 21)

(SATA2_5, см. стр. 2, п. 20)

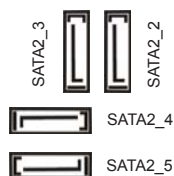

четыре соединителя Serial ATA2 предназначены для подключения внутренних устройств хранения с использованием интерфейсных кабелей SATA2. В настоящее время интерфейс SATA допускает скорость передачи данных до \ 3,0 Гбит/с.

Разъемы Serial ATA3

(SATA3_A0_A1, см. стр. 2, п. 12)

(SATA3_0_1, см. стр. 2, п. 13)

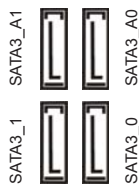

четыре соединителя Serial ATA3 предназначены для подключения внутренних устройств хранения с использованием интерфейсных кабелей SATA3. В настоящее время интерфейс SATA допускает скорость передачи данных до \ 6,0 Гбит/с. При подключении порта eSATA3 на задней панели входов/выходов внутренний разъем SATA3_A1 не функционирует.

Информационный кабель Serial ATA (SATA)
(дополнительно)



Информационный кабель интерфейса SATA / SATA2 / SATA3 не является направленным. Любой из его соединителей может быть подключен либо к жесткому диску интерфейса SATA2 / SATA3 либо к материнской плате.

Разъем порта печати
(25-выводов LPT1)
(см. стр. 2, п.28)

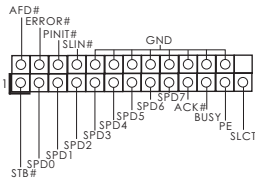

Это интерфейс кабеля порта печати, обеспечивающий удобное подключение принтеров.

Колodka USB 2.0
(9-контактный USB_6_7)
(см. стр. 2, п. 25)

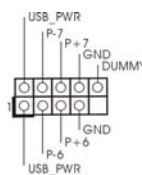

Помимо четыре стандартных портов USB 2.0 на панели ввода-вывода, на данной материнской плате предусмотрено три разъема USB 2.0. Каждый разъем USB 2.0 поддерживает два порта USB 2.0.

(9-контактный USB_8_9)
(см. стр. 2, п. 24)

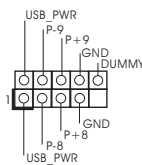

(9-контактный USB_10_11)
(см. стр. 2, п. 23)

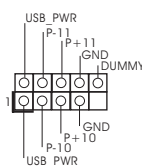

Колodka USB 3.0
(19-контактный USB3_12_13)
(см. стр. 2, п. 9)

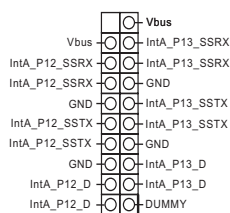

Помимо два стандартных портов USB 3.0 на панели ввода-вывода, на данной материнской плате предусмотрен один разъем USB 3.0. Этот разъем USB 3.0 поддерживает два порта USB 3.0.

Колodka инфракрасного модуля
(5-контактный IR1)
(см. стр. 2, п. 19)

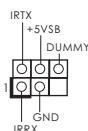

Данная колodka позволяет подключить дополнительный модуль беспроводного инфракрасного приемопередатчика.

Датчик пользовательского инфракрасного модуля
(4-контактный CIR1)
(см. стр. 2, п. 26)



Датчик можно использовать для подключения дистанционный приемник.

Аудиоразъем передней панели
(9-контактный HD_AUDIO1)
(см. стр. 2, п. 33)

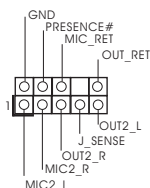

Этот интерфейс предназначен для присоединения аудиокабеля передней панели, обеспечивающего удобное подключение аудиоустройств и управление ими.



1. Система High Definition Audio поддерживает функцию автоматического обнаружения разъемов (Jack Sensing), однако для ее правильной работы кабель панели в корпусе должен поддерживать HDA. При сборке системы следуйте инструкциям, приведенным в нашем руководстве и руководстве пользователя для корпуса.
2. Если вы используете аудиопанель AC'97, подключите ее к колодке аудиоинтерфейса передней панели следующим образом:
 - A. Подключите выводы Mic_IN (MIC) к контактам MIC2_L.
 - B. Подключите выводы Audio_R (RIN) к контактам OUT2_R, а выводы Audio_L (LIN) к контактам OUT2_L.
 - C. Подключите выводы Ground (GND) к контактам Ground (GND).
 - D. Контакты MIC_RET и OUT_RET предназначены только для аудиопанели HD. При использовании аудиопанели AC'97 подключать их не нужно.
 - E. Процедура активации микрофона приведена ниже.
Для ОС Windows® XP / XP 64-бита:
Выберите «Mixer» (Микшер). Выберите «Recorder» (Устройство записи). Затем щелкните «FrontMic» (Передний микрофон).
Для ОС Windows® 7 / 7 64-бита, Vista™ / Vista™ 64-бита:
Перейдите к вкладке «FrontMic» (Передний микрофон) в панели управления Realtek. Отрегулируйте уровень «Recording Volume» (Громкость записи).

Колодка системной панели
(9-контактный PANEL1)
(см. стр. 2, п. 18)

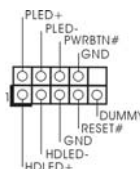

Данная колодка обеспечивает работу нескольких функций передней панели системы.



Подключите к этому разъему кнопку питания, кнопку сброса и индикатор состояния системы на корпусе в соответствии с указанным ниже назначением контактов. При подключении кабелей необходимо соблюдать полярность положительных и отрицательных контактов.

PWRBTN (кнопка питания):

Подключите к этим контактам кнопку питания на передней панели корпуса. Способ выключения системы с помощью кнопки питания можно настроить.

RESET (кнопка сброса):

Подключите к этим контактам кнопку сброса на передней панели корпуса. Нажмите кнопку сброса для перезагрузки компьютера, если компьютер «завис» и нормальную перезагрузку выполнить не удастся.

PLED (индикатор питания системы):

Подключите к этим контактам индикатор состояния питания на передней панели корпуса. Этот индикатор светится, когда система работает. Индикатор мигает, когда система находится в режиме ожидания S1/S3. Этот индикатор не светится, когда система находится в режиме ожидания S4, либо выключена (S5).

HDLED (индикатор активности жесткого диска):

Подключите к этим контактам индикатор активности жесткого диска на передней панели корпуса. Этот индикатор светится, когда осуществляется считывание или запись данных на жестком диске.

Конструкция передней панели может различаться в зависимости от корпуса. Модуль передней панели в основном состоит из кнопки питания, кнопки сброса, индикатора питания, индикатора активности жесткого диска, динамика и т.п. При подключении к этому разъему модуля передней панели корпуса удостоверьтесь, что провода подключаются к соответствующим контактам.

Русский

Колодка динамика корпуса
(4-контактный SPEAKER1)
(см. стр. 2, п. 16)

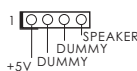

Подключите к этой колодке кабель от динамика на корпусе компьютера.

разъем Power LED
(3-контактный PLED1)
(см. стр. 2, п. 17)



Подключите индикатор Power LED к этому разъему для отображения статуса питания системы. Этот светодиод продолжит мигать в режиме S1/S3. Светодиод будет выключен в режимах S4 или S5 (система выключена).

Chassis и Power Fan-соединители
(4-контактный CHA_FAN1)
(см. стр. 2, п. 22)



(3-контактный CHA_FAN2)
(см. стр. 2, п. 35)

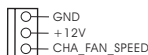

(3-контактный PWR_FAN1)
(см. стр. 2, п. 2)

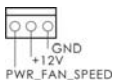

Подключите кабели вентилятора к соединителям и присоедините черный шнур к штырю заземления. CHA_FAN1 и CHA_FAN2 поддерживают функцию управления вентилятором.

Разъем вентилятора процессора
(4-контактный CPU_FAN1)
(см. стр. 2, п. 3)

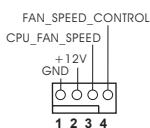

Подключите к этому разъему кабель вентилятора процессора так, чтобы черный провод соответствовал контакту земли.



Данная материнская плата поддерживает вентиляторы процессора с 4-контактным разъемом (функция тихого режима вентилятора), однако вентиляторы с 3-контактным разъемом также будут успешно работать, хотя функция управления скоростью вращения вентилятора окажется недоступной. Если вы хотите подключить вентилятор процессора с 3-контактным разъемом к разъему вентилятора процессора на данной материнской плате, для этого следует использовать контакты 1-3.

Контакты 1-3 подключены ←

Установка вентилятора с 3-контактным разъемом

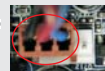

(3-контактный CPU_FAN2)
(см. стр. 2, п. 1)

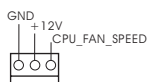

Русский

Колодка питания ATX
(24-контактный ATXPWR1)
(см. стр. 2, п. 8)

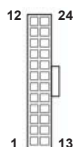

Подключите к этой колодке кабель питания ATX.



Несмотря на то, что эта материнская плата предусматривает 24-штыревой разъем питания ATX, работа будет продолжаться, даже если адаптируется традиционный 20-штыревой разъем питания ATX. Для использования 20-штыревого разъема питания ATX вставьте источник питания вместе со штекером 1 и штекером 13.

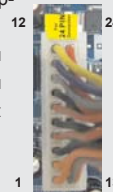

Установка 20-штыревого разъема питания ATX 1 13

Колодка питания 12V-ATX
(8-контактный ATX12V1)
(см. стр. 2, п. 4)



Подключите к этой колодке кабель питания ATX 12V.



Хотя эта объединительная плата обеспечивает ATX с 8 булавками 12V соединитель власти, это может все еще работать, если Вы принимаете традиционный ATX с 4-Pin 12V электропитание. Чтобы использовать электропитание ATX с 4-Pin, пожалуйста включите ваше электропитание наряду с Булавкой 1 и Прикрепите 5.



ATX C 4-Pin 12V Установка Электропитания 4 1

Колодка COM-порта
(9-контактный COM1)
(см. стр. 2, п. 27)

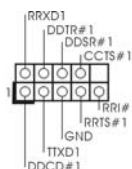

Данная колодка COM-порта позволяет подключить модуль порта COM.

Колодка HDMI_SPDIF
(2-контактный HDMI_SPDIF1)
(см. стр. 2, п. 29)



Колодка HDMI_SPDIF обеспечивает подачу выходного аудиосигнала на VGA-карту HDMI, что позволяет подключать к системе цифровые телевизоры, проекторы или жидкокристаллические панели HDMI. Соедините эту колодку с разъемом HDMI_SPDIF на VGA-карте HDMI.

2. Информация о BIOS

Утилита настройки BIOS (BIOS Setup) хранится во флэш-памяти на материнской плате. Чтобы войти в программу настройки BIOS Setup, при запуске компьютера нажмите <F2> или во время самопроверки при включении питания (Power-On-Self-Test – POST). Если этого не сделать, то процедуры тестирования POST будут продолжаться обычным образом. Если вы захотите вызвать BIOS Setup уже после POST, перезапустите систему с помощью клавиш <Ctrl> + <Alt> + <Delete> или нажатия кнопки сброса на корпусе системы. Подробную информацию о программе BIOS Setup вы найдете в Руководстве пользователя (в формате PDF) на компакт-диске поддержки.

3. Информация о компакт-диске поддержки с программным обеспечением

Данная материнская плата поддерживает различные операционные системы Microsoft® Windows®: 7 / 7 64-bit / Vista™ / Vista™ 64-bit / XP / XP 64-bit. Поставляемый вместе с ней компакт-диск поддержки содержит необходимые драйверы и полезные утилиты, которые расширяют возможности материнской платы.

Чтобы начать работу с компакт-диском поддержки, вставьте его в дисковод CD-ROM. Если в вашем компьютере включена функция автозапуска (AUTORUN), то на экране автоматически появится главное меню компакт-диска (Main Menu). Если этого не произошло, найдите в папке BIN на компакт-диске поддержки файл ASSETUP.EXE и дважды щелкните на нем, чтобы открыть меню.

1. Introdução

Gratos por comprar nossa placa-mãe **Z77 Pro4-M** um produto confiável feito com ASRock um estrito controle de qualidade consistente. Com um excelente desempenho, essa placa é dotada de um projeto robusto que atende a ASRock de compromisso com a qualidade e durabilidade.

Este Guia de Instalação Rápida apresenta a placa-mãe e o guia de instalação passo a passo. Mais informações detalhadas sobre a placa-mãe podem ser encontradas no manual do usuário do CD de suporte.



Porque as especificações da placa mãe e o software de BIOS poderiam ser atualizados, o conteúdo deste manual pode ser cambiado sem aviso. Em caso de qualquer modificação deste manual, a versão atualizada estará disponível no website de ASRock sem prévio aviso. Pode também encontrar as listas das mais recentes placas VGA e das CPUs suportadas no site da web da ASRock.

Website de ASRock <http://www.asrock.com>

Se precisar de apoio técnico em relação a este placa-mãe, por favor visite o nosso sítio da internet para informação específica acerca do modelo que está a utilizar.

www.asrock.com/support/index.asp

1.1 Este pacote contém

Placa-mãe ASRock **Z77 Pro4-M**

(Formato Micro ATX: 9,6 pol. x 9,6 pol., 24,4 cm x 24,4 cm)

Guia de instalação rápida da ASRock **Z77 Pro4-M**

CD de suporte da placa ASRock **Z77 Pro4-M**

Dois cabo de dados ATA Serial (SATA) (Opcional)

Uma proteção I/O



A ASRock recorda-lhe...

Para obter melhor desempenho em Windows® 7 / 7 64-bit / Vista™ / Vista™ 64-bit, recomendamos que defina a opção Configuração de Armazenamento na BIOS para o modo AHCI. Para mais detalhes acerca da configuração da BIOS consulte o "Manual de utilizador" no nosso CD de suporte.

1.2 Especificações

Plataforma	<ul style="list-style-type: none"> - Formato Micro ATX: 9,6 pol. x 9,6 pol., 24,4 cm x 24,4 cm - Design de condensadores banhados a ouro de alta qualidade (Condensadores de polímeros condutores de alta qualidade 100% fabricados no Japão)
CPU	<ul style="list-style-type: none"> - Suporta Intel® Core™ i7 / i5 / i3 de 3ª e 2ª geração no pacote LGA1155 - Design de Poder Digital - Alimentação de 4 + 2fases - Suporta a tecnologia Intel® Turbo Boost 2.0 - Suporta K-Series desbloqueado CPU - Suporta a tecnologia Hyper-Threading (veja o AVISO 1) - Suporta a tecnologia Rapid Start da Intel® e a tecnologia Smart Connect com CPU Ivy Bridge da Intel®
Chipsets	- Intel® Z77
Memória	<ul style="list-style-type: none"> - Suporte à tecnologia de memória de duplo canal (veja o AVISO 2) - 4 x slots de DDR3 DIMM - Suporte para memória não intermédia DDR3 2800+(OC)/2400 (OC)/2133(OC)/1866(OC)/1600/1333/1066, não ECC - Capacidade máxima de memória do sistema: 32GB (veja o AVISO 3) - Suporta Extreme Memory Profile (XMP)1.3/1.2 da Intel®
Slots de Expansão	<ul style="list-style-type: none"> - 1 x slot de PCI Express 3.0 x16 (PCIE1: versão x16) (veja o AVISO 4) * O modo PCIE 3.0 apenas é suportado com a CPU Ivy Bridge da Intel® A CPU Sandy Bridge da Intel® apenas suporta o modo PCIE 2.0. - 2 x slot de PCI Express 2.0 x16 (PCIE3 modo @ x1; PCIE4 modo @ x4) - 1 x slot de PCI Express 2.0 x1 - Suporta Quad CrossFireX™ e CrossFireX™ da AMD
VGA integrado	<ul style="list-style-type: none"> * As saídas Intel® HD Graphics Built-in Visuals e VGA são suportadas apenas por processadores com GPU integrada. - Suporta Intel® HD Graphics Embutido Visuals: Intel® Quick Sync Video 2.0, Intel® InTru™ 3D, Intel® Clear Video HD Technology, Intel® Insider™, Intel® HD Graphics 2500/4000 - Pixel Shader 5.0, DirectX 11 com Intel® Ivy Bridge CPU, Pixel Shader 4.1, DirectX 10.1 com processadores Intel® Sandy Bridge CPU - Memória partilhada máxima 1760MB (veja o AVISO 5)

	<ul style="list-style-type: none"> - Três opções de saída VGA: D-Sub, DVI-D e HDMI (veja o AVISO 6) - Suporta HDMI 1.4a Tecnologia com resolução máxima até 1920x1200 @ 60Hz - Suporta DVI com resolução máxima até 1920x1200 @ 60Hz - Suporta D-Sub com resolução máxima até 2048x1536 @ 75Hz - Suporta as funções Auto Lip Sync (Sincronização automática do som), Deep Color (Profundidade da cor) (12bpc), xvYCC e HBR (áudio de taxa de bits elevada) com HDMI (é necessário um monitor compatível com a norma HDMI) (veja o AVISO 7) - Suporta função HDCP com portas DVI e HDMI - Suporta a norma Blu-ray de alta definição 1080p (BD) / e a reprodução de DVDs de alta definição com portas DVI e HDMI
Áudio	<ul style="list-style-type: none"> - Áudio HD de 7.1 canais com protecção de conteúdo (Realtek ALC892 Audio Codec) - Suporte áudio Blu-ray superior - Suporta TruStudio™ da THX
LAN	<ul style="list-style-type: none"> - PCIE x1 Gigabit LAN 10/100/1000 Mb/s - Realtek RTL8111E - Suporta Wake-On-LAN - Suporta Detecção de cabo LAN - Suporta Ethernet com Eficiência Energética 802.3az - Suporta PXE
Entrada/Saída pelo painel	<p>I/O Panel</p> <ul style="list-style-type: none"> - 1 x porta para teclado PS/2 - 1 x porta D-Sub - 1 x porta DVI-D - 1 x porta HDMI - 1 x Porta de saída SPDIF óptica - 4 x portas USB 2.0 padrão - 1 x Conector eSATA3 - 2 x portas USB 3.0 padrão - 1 x porta LAN RJ-45 com LED (LED ACT/LIG e LED VELOCIDADE) - Ficha de áudio HD: Altifalante traseiro/Central/Baixos/Entrada de linha/Altifalante frontal/Microfone (veja o AVISO 8)
SATA3	<ul style="list-style-type: none"> - 2 x conectores SATA3 a 6,0 Gb/s através Z77 da Intel®, com suporte para RAID (RAID 0, RAID 1, RAID 5, RAID 10, Intel Rapid Storage e Intel Smart Response Technology), NCQ, AHCI e funções Hot Plug

	<ul style="list-style-type: none"> - 2 x conectores SATA3 a 6,0 Gb/s através de ASM1061 da ASMedia, com suporte para NCQ, AHCI e funções Hot Plug (O conector SATA3_A1 é partilhado com a porta eSATA3)
USB3.0	<ul style="list-style-type: none"> - 2 x Portas USB 3.0 traseiras, com suporte para USB 1.0/2.0/3.0 até 5Gb/s - 1 x Conector USB 3.0 frontal (suporta 2 portas USB 3.0), com suporte para USB 1.0/2.0/3.0 até 5Gb/s
Conectores	<ul style="list-style-type: none"> - 4 x conectores SATA2 a 3,0 Gb/s, com suporte para RAID (RAID 0, RAID 1, RAID 5, RAID 10, Intel Rapid Storage e Intel Smart Response Technology), NCQ, AHCI e funções Hot Plug - 4 x conectores SATA3, suporte a taxa de transferência de dados de até 6,0 Gb/s - 1 x Conector do módulo de infravermelho - 1 x Conector CIR - 1 conector para porta de impressão - 1 x conector de porta COM - 1 x Conector HDMI_SPDIF - 1 x Conector para LED de alimentação - Conector do ventilador da CPU/chassis/energia - Conector de força do ATX de 24 pinos - Conector ATX 12 V de 8 pinos - Conector Áudio do painel frontal - 3 x cabezal USB 2.0 (suporta 6 portas USB 2.0) - 1 x cabezal USB 3.0 (suporta 2 portas USB 3.0)
BIOS	<ul style="list-style-type: none"> - 64mb BIOS UEFI oficial da AMI com suporte para GUI - Suporta dispositivos "Plug and Play" - ACPI 1.1 atendendo a eventos de "wake up" - Suporta dispositivos sem jumper - Suporte para SMBIOS 2.3.1 - CPU Core, IGPU, DRAM, 1.8V PLL, VTT, VCCSA Voltage Multi-adjustment
CD de suporte	<ul style="list-style-type: none"> - Controladores, utilitários, software antivírus (Experimentacao Versao), CyberLink MediaEspresso 6.5 versão de demonstração, ASRock MAGIX Multimedia Suite - OEM
Funcionalidade Única	<ul style="list-style-type: none"> - ASRock Extreme Tuning Utility (AXTU) (veja o AVISO 9) - ASRock Instant Boot - ASRock Instant Flash (veja o AVISO 10) - ASRock APP Charger (veja o AVISO 11) - ASRock SmartView (veja o AVISO 12) - ASRock XFast USB (veja o AVISO 13) - ASRock XFast LAN (veja o AVISO 14) - ASRock XFast RAM (veja o AVISO 15)

	<ul style="list-style-type: none"> - ASRock Crashless BIOS (veja o AVISO 16) - ASRock OMG (Online Management Guard) (veja o AVISO 17) - Lucid Virtu Universal MVP (veja o AVISO 18) * Lucid Virtu Universal MVP é suportado apenas por processadores com GPU integrada. - Tecnologia ASRock On/Off Play (veja o AVISO 19) - Booster híbrido: <ul style="list-style-type: none"> - Controlo contínuo de frequência da CPU (veja o AVISO 20) - ASRock U-COP (veja o AVISO 21) - B.F.G. (Boot Failure Guard) - Suporta para a tecnologia C.C.O. (Combo Cooler Option) (veja o AVISO 22) - Good Night LED
Monitor do HW	<ul style="list-style-type: none"> - Sensores de temperature do procesador - Medição de temperatura da placa-mãe - Tacómetros de ventilador do Processador/chassis/energia - Ventoinha silenciosa para a CPU/chassis (Permitir velocidade Chassis Auto-Ajuste de temperatura da CPU) - CPU/Chassis Fan Controle Multi-Velocidade - Monitoramento de voltagem : +12 V, +5 V, +3.3 V, Vcore
Sistema Operacional	<ul style="list-style-type: none"> - Microsoft® Windows® 7 / 7 de 64 bits / Vista™ / Vista™ de 64 bits / XP / XP de 64 bits (veja o AVISO 23)
Certificações	<ul style="list-style-type: none"> - FCC, CE, WHQL - “ErP/EuP Ready” (é necessária alimentação eléctrica “ErP/EuP Ready”) (veja o AVISO 24)

* Para informações mais detalhadas por favor visite o nosso sítio Web: <http://www.asrock.com>

AVISO

Tenha em atenção que a operação de overlocking envolve alguns riscos, nomeadamente no que diz respeito ao ajuste das definições do BIOS, à aplicação da tecnologia Untied Overclocking ou à utilização de ferramentas de overlocking de terceiros. O overlocking pode afectar a estabilidade do seu sistema ou até mesmo causar danos ao nível dos componentes e dispositivos que integram o sistema. Esta operação é da total responsabilidade do utilizador. Não nos responsabilizamos pelos possíveis danos resultantes do overlocking.

AVISO!

1. Sobre a configuração da "Tecnologia Hyper Threading", consulte a página 52 do Manual do Usuário no CD de suporte. (Somente inglês)
2. Esta placa-mãe suporta a tecnologia de memória de duplo canal. Antes de implementar a tecnologia de memória de duplo canal, certifique-se de ler o guia de instalação dos módulos de memória na página 17.
3. Devido às limitações do sistema operativo, o tamanho real da memória pode ser inferior a 4 GB uma vez que uma parte desta está reservada para utilização pelo sistema operativo no âmbito do Windows® 7 / Vista™ / XP. No caso da CPU de 64 bits do Windows® OS, esta limitação não existe. Pode usar a função ASRock XFast RAM para utilizar a memória que o Windows® não pode utilizar.
4. Apenas as ranhuras PCI-E1 suportam a velocidade Gen 3. Para que a placa PCI Express funcione à velocidade Gen 3, deve instalar a CPU Ivy Bridge. Se instalar a CPU Sandy Bridge, a placa PCI Express apenas funcionará à velocidade PCI Express Gen 2.
5. O máximo tamanho de memória compartilhada é definido por vendedor de chipset e é sujeito a mudar. Verifique o Intel® website para a última informação.
6. Pode optar por usar apenas dois dos três monitores. Os monitores D-Sub, DVI-D e HDMI não podem ser activados ao mesmo tempo. Para além disso, com o adaptador DVI-para-HDMI a porta DVI-D pode suportar as mesmas funções que a porta HDMI.
7. As funções xvYCC e Deep Color (Profundidade da cor) apenas são suportadas no Windows® 7 64-bits / 7. O modo Deep Color (Profundidade da cor) apenas será activado se o monitor suportar 12bpc em EDID. A função HBR é suportada no Windows® 7 64-bits / 7 / Vista™ 64-bits / Vista™.
8. Para a entrada de microfone, esta placa principal suporta os modos estéreo e mono. Para a saída de áudio, esta placa principal suporta os modos de 2 canais, 4 canais, 6 canais e 8 canais. Consulte a tabela na página 3 para obter informações acerca das ligações mais adequadas.
9. ASRock Extreme Tuning Utility (AXTU) é uma ferramenta completa para ajustar diferentes funções do sistema através de uma interface fácil de utilizar, que inclui o Monitor de Hardware, Controlo de Ventoinha, Overclocking, OC DNA e IES. O Monitor de Hardware, exibe as principais informações do sistema. O Controlo de Ventoinha, permite ajustar a velocidade da ventoinha e a temperatura. Em Overclocking, poderá ajustar a frequência da CPU para melhorar o desempenho do sistema. Em OC DNA, pode guardar as suas definições de OC como um perfil e partilhar com os seus amigos. Os seus amigos poderão carregar o perfil de OC nos seus sistemas para obter as mesmas definições de OC. Em IES (Poupança de Energia Inteligente), o regulador de tensão pode reduzir o número de fases de saída para aumentar a eficiência quando os núcleos de CPU estiverem inactivos sem diminuir o desempenho de processamento. Visite a nossa página Web para obter instruções acerca da

utilização do ASRock Extreme Tuning Utility (AXTU).

Página Web da ASRock: <http://www.asrock.com>

10. ASRock Instant Flash est un utilitaire de flash du BIOS flash intégré dans la ROM Flash. Cet outil pratique de mise à jour du BIOS vous permet de mettre à jour le BIOS du système sans entrer d'abord dans un système d'exploitation tel que MS-DOS ou Windows®. Avec cet utilitaire, vous pouvez appuyer sur la touche <F6> pendant le POST ou sur la touche <F2> durant le menu de configuration du BIOS pour accéder à ASRock Instant Flash. Lancez simplement cet outil et enregistrez le nouveau fichier BIOS sur votre lecteur flash USB, sur une disquette ou un disque, avant de pouvoir mettre à jour votre BIOS en quelques clics seulement, sans préparer de disquette supplémentaire ni d'autre utilitaire flash compliqué. Veuillez noter que le lecteur flash USB ou le disque dur doit utiliser le système de fichiers FAT32/16/12.
11. Se pretende carregar os seus dispositivos Apple, como o iPhone/iPad/iPod Touch, de forma mais rápida e menos limitada, a ASRock preparou para si uma solução fantástica, o ASRock APP Charger. Instale o controlador APP Charger para que o seu iPhone carregue mais rapidamente a partir do computador, até 40% mais rápido do que antes. O ASRock APP Charger permite-lhe carregar rapidamente vários dispositivos Apple em simultâneo e suporta até o carregamento quando o seu PC entrar em modo de Espera (S1), Suspensão (S3), Hibernação (S4) ou desligado (S5). Com o controlador APP Charger instalado, poderá desfrutar facilmente da melhor experiência de carregamento.
Web site da ASRock: <http://www.asrock.com/Feature/AppCharger/index.asp>
12. O SmartView, uma nova função para navegadores de Internet, é uma página inicial inteligente para o IE que combina os seus sites mais visitados, o seu histórico, os seus amigos do Facebook e o seu feed de notícias em tempo real numa página avançada para oferecer uma experiência de Internet mais pessoal. As placas principais da ASRock estão equipadas exclusivamente com o utilitário SmartView que lhe permite manter-se facilmente em contacto com os seus amigos. Para utilizar a funcionalidade SmartView, certifique-se de que a sua versão de SO é Windows® 7 / 7 64 bit / Vista™ / Vista™ 64 bit, e que a versão do seu navegador é IE8.
Página Web da ASRock: <http://www.asrock.com/Feature/SmartView/index.asp>
13. O ASRock XFast USB pode aumentar a velocidade dos dispositivos de armazenamento USB. A velocidade poderá depender das propriedades dos dispositivos.
14. O ASRock XFast LAN proporciona um acesso à Internet mais rápido, que inclui os benefícios abaixo. Priorização de Aplicações LAN: O utilizador pode configurar a prioridade da aplicação de forma ideal e/ou pode adicionar novos programas. Menor Latência nos Jogos: Depois de definir maior prioridade para o jogo on-line, pode baixar a latência no

- jogo. Traffic Shaping: Pode assistir a vídeos do Youtube em HD e transferir ficheiros em simultâneo. Análise em tempo real dos seus dados: Com a janela de estado, pode reconhecer facilmente os fluxos de dados das suas transferências actuais.
15. ASRock XFast RAM é uma nova função incluída ao utilitário ASRock Extreme Tuning Utility (AXTU). Esta função utiliza totalmente o espaço de memória que não pode ser utilizado pela CPU no SO Windows® OS de 32 bits. A função ASRock XFast RAM diminui o tempo de carregamento de Web sites visitados anteriormente, tornando a navegação na Internet mais rápida. E aumenta 5 vezes a velocidade do Adobe Photoshop. Outra vantagem da função ASRock XFast RAM é a redução da frequência de acesso aos SSD ou HDD aumentando assim a sua duração.
 16. O ASRock Crashless BIOS permite que os utilizadores actualizem a sua BIOS sem receio de falhas. Se ocorrer uma interrupção de energia durante o processo de actualização da BIOS, o ASRock Crashless BIOS retoma automaticamente o processo de actualização da BIOS após o restabelecimento da energia. Tenha em atenção que será necessário colocar os ficheiros da BIOS no directório de raiz do seu disco USB. Esta funcionalidade apenas é suportada em portas USB 2.0.
 17. Através do OMG os administradores podem interditar ou impedir o acesso à internet em horários específicos. É possível escolher entre [Todos os dias], [Dia útil] ou [Dias úteis e fins-de-semana] e depois agendar as horas de início e fim do acesso à Internet concedido a outros utilizadores. Para impedir que os utilizadores contornem o OMG, são necessárias contas de convidado sem permissão para modificar a hora do sistema.
 18. A tecnologia VIRTU Universal MVP inclui as funções básicas da tecnologia Virtu Universal a qual permite virtualizar a GPU integrada e a GPU discreta para que seja possível desfrutar do que de melhor ambas têm para oferecer. Esta tecnologia inclui também a tecnologia Virtual Vsync™ a qual proporciona uma qualidade visual sem compromissos. Graças às vantagens proporcionadas pela tecnologia HyperFormance, a tecnologia VIRTU Universal MVP melhora o desempenho ao nível dos jogos através da redução inteligente das tarefas de rendering entre a CPU, a GPU e o monitor.
 19. A tecnologia ASRock On/Off Play permite aos utilizadores desfrutarem da fantástica experiência de áudio a partir de dispositivos portáteis de áudio, como leitores MP3 ou telemóveis no PC, mesmo que o PC esteja desligado (ou no modo ACPI S5)! Esta placa-mãe também proporciona uma ligação para cabo de áudio de 3,5 mm (opcional) que assegura aos utilizadores o mais conveniente ambiente informático.
 20. Embora esta placa principal ofereça controlo contínuo, não recomendamos que aumente a velocidade do processador. Outras frequências diferentes das frequências de barramento da CPU recomendadas poderão causar instabilidade no sistema ou danificar a CPU.

-
21. Assim que se detecta um superaquecimento na CPU, o sistema se desliga automaticamente e o botão de energia do chassis fica inativo. Cheque o ventilador da CPU na placa-mãe, para verificar se está funcionando corretamente antes de religar o sistema. Para melhorar a dissipação de calor, lembre-se de aplicar o material de interface térmica entre o processador e o dissipador de calor.
 22. O Combo Cooler Option (C.C.O.) oferece uma opção flexível para adotar diferentes tipos de dissipadores de CPU, Socket LGA 775, LGA 1155 e LGA 1156. Tenha em atenção que nem todos os dissipadores de CPU 775 e 1156 poderão ser utilizados.
 23. ASRock XFast RAM não é suportada nos sistemas operativos Microsoft® Windows® XP / XP de 64 bits. Tecnologia Smart Connect da Intel® e portas USB 3.0 da Intel® não é suportada nos sistemas operativos Microsoft® Windows® Vista™ / Vista™ de 64 bits / XP / XP de 64 bits.
 24. EuP, que significa Energy Using Product (Produto que Utiliza Energia), foi uma provisão regulada pela União Europeia para definir o consumo de energia para o sistema concluído. De acordo com a EuP, a corrente AC total do sistema concluído deverá ser inferior a 1.00W no estado de modo desligado. Para satisfazer a norma EuP, é necessário uma placa-mãe e uma fonte de alimentação eléctrica que estejam em conformidade com a norma EuP. De acordo com a sugestão da Intel, a fonte de alimentação em conformidade com a norma EuP deve satisfazer o padrão, isto é, a eficiência energética de reserva de 5v deve ser superior a 50% com um consumo de corrente de 100 mA. Para selecção da fonte de alimentação em conformidade com a norma EuP, recomendamos que confirme com o fabricante da fonte de alimentação para mais detalhes.

1.3 Configuração dos Jumpers

A ilustração mostra como os jumpers são configurados. Quando há uma capa de jumpers sobre os pinos, diz-se que o jumper está “curto”. Não havendo capa sobre os pinos, o jumper está “aberto”. A ilustração mostra um jumper de 3 pinos em que os pinos 1 e 2 estão “curtos” quando a capa de jumper estiver colocada sobre esses 2 pinos.

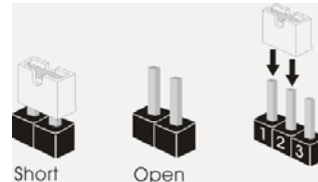

Jumper	Configuração				
Restaurar CMOS (CLRCMOS1, jumper de 3 pinos) (veja a folha 2, No. 15)	<table><tr><td>1_2 ● ● ○</td><td>2_3 ○ ● ●</td></tr><tr><td>Configuração-padrão</td><td>Limpar o CMOS</td></tr></table>	1_2 ● ● ○	2_3 ○ ● ●	Configuração-padrão	Limpar o CMOS
1_2 ● ● ○	2_3 ○ ● ●				
Configuração-padrão	Limpar o CMOS				

Nota: CLRCMOS1 permite você limpar os dados em CMOS. Os dados em CMOS incluem informações da configuração do sistema como: por exemplo a senha do sistema, data, tempo, e os parâmetros da configuração do sistema. Para limpar e reconfigurar os parâmetros do sistema a configuração inicial da fábrica, por favor desligue o cabo de força, ponha em curto-circuito os pin 2 e pin 3 de CLRCMOS1 por mais de 5 segundos para limpar o CMOS usando um jumper. Por favor lembre-se de remover o jumper depois de limpar o CMOS. Se precisar limpar o CMOS ao concluir a atualização do BIOS, deverá reiniciar o sistema primeiro e, em seguida, desligá-lo antes de executar a ação de limpeza o CMOS. Tenha em atenção que a palavra-passe, data, hora, perfil predefinido de utilizador, 1394 GUID e endereço MAC apenas serão limpos se a bateria do CMOS for retirada.

1.4 Conectores



Os conectores NÃO SÃO jumpers. NÃO coloque capas de jumper sobre estes conectores. A colocação de pontos de jumper sobre os conectores causará danos irreversíveis à placa-mãe.

Conectores ATA2 Serial

(SATA2_2_3: veja a folha 2, No. 14)

(SATA2_4: veja a folha 2, No. 21)

(SATA2_5: veja a folha 2, No. 20)

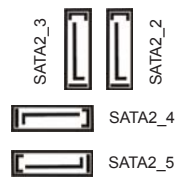

Estes quatro conectores Serial ATA (SATA2) suportam unidades de disco rígido SATA ou SATA2 como dispositivos de armazenamento internos. A atual interface SATA2 permite uma taxa de transferência de dados de até 3.0 Gb/s.

Conectores ATA3 Serial

(SATA3_A0_A1: veja a folha 2, No. 12)

(SATA3_0_1: veja a folha 2, No. 13)

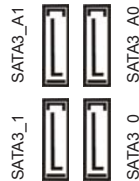

Estes quatro conectores Serial ATA (SATA3) suportam unidades de disco rígido SATA ou SATA3 como dispositivos de armazenamento internos. A atual interface SATA3 permite uma taxa de transferência de dados de até 6.0 Gb/s. Se tiver ligado a porta eSATA3 no painel de entrada/saída existente na parte de trás, a função SATA3_A1 interna não funcionará.

Cabo de dados
ATA (SATA)
(opcional)



Tanto a saída do cabo de Serial dados SATA pode ser conectada ao disco rígido SATA / SATA2 / SATA3 quanto o conector SATA2 / SATA3 na placa mãe.

Porta de impressão

(LPT1 de 25 pinos)
(veja a folha 2, No. 28)

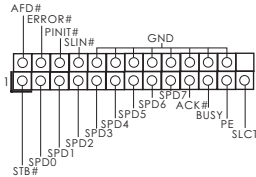

Esta é a interface do cabo que liga à porta de impressão e permite a fácil ligação de impressoras.

Cabezal USB 2.0

(USB_6_7 de 9 pinos)
(veja a folha 2, No. 25)

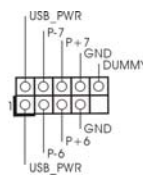

Além das quatro portas USB 2.0 por defeito no painel de entrada/saída, há três ligações USB 2.0 nesta placa-mãe. Cada ligação USB 2.0 pode suportar dois portas USB 2.0.

(USB_8_9 de 9 pinos)
(veja a folha 2, No. 24)

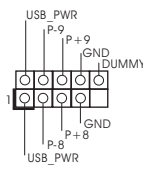

(USB_10_11 de 9 pinos)
(veja a folha 2, No. 23)

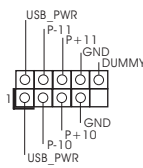

Cabezal USB 3.0

(USB3_12_13 de 19 pinos)
(veja a folha 2, No. 9)

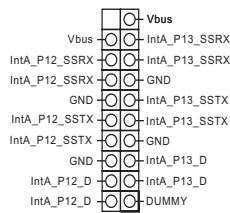

Além das duas portas USB 3.0 por defeito no painel de entrada/saída, há um ligações USB 3.0 nesta placa-mãe. Cada ligação USB 3.0 pode suportar dois portas USB

Conector do módulo de infravermelho

(IR1 de 5 pinos)
(veja a folha 2, No. 19)

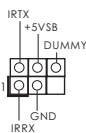

Este conector suporta um módulo de infravermelho para transmissão e recepção sem fio, opcional.

Conector do módulo de infravermelhos
(CIR1 de 4 pinos)
(veja a folha 2, No. 26)

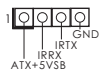

Este conector pode ser utilizado para ligar o receptor do controlo remoto.

Conector Áudio do painel frontal
(HD_AUDIO1 de 9 pinos)
(veja a folha 2, No. 33)

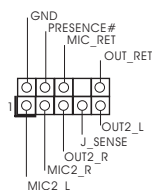

Esta é uma interface para o cabo de áudio no painel frontal, que permite uma conexão e controle convenientes dos dispositivos de áudio.



1. Áudio de elevada definição que suporta a sensibilidade da tomada, mas o fio do painel existente no chassis tem de suportar HDA para funcionar correctamente. Siga s instruções que aparecem no manual e no manual do chassis para instalar o sistema.
2. Se utilizar o painel de áudio AC'97, instale-o no cabeçalho de áudio do painel frontal, como a figura abaixo mostra:
 - A. Ligue o Mic_IN (MIC) ao MIC2_L.
 - B. Ligue o Audio_R (RIN) ao OUT2_R e o Audio_L (LIN) ao OUT2_L.
 - C. Ligue o Ground (GND) ao Ground (GND).
 - D. MIC_RET e OUT_RET são apenas para o painel de áudio HD. Não necessita de os ligar para o painel de áudio AC'97.
 - E. Para activar o microfone frontal.
Para os Sistemas Operativos Windows® XP / XP 64 bits:
Selecione "Misturador". Selecione "Gravador". Depois clique em "Microfone frontal".
Para os Sistemas Operativos Windows® 7 / 7 64-bit / Vista™ / Vista™ 64-bit:
Aceda ao separador "Microfone frontal" no painel de Controlo Realtek. Ajuste o "Volume de gravação".

Conector do painel do sistema
(PANEL1 de 9 pinos)
(veja a folha 2, No. 18)

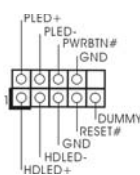

Este conector acomoda várias funções do painel frontal do sistema.



Ligue o botão de alimentação, o botão de reposição e o indicador do estado do sistema no chassis a este conector de acordo com a descrição abaixo. Tenha em atenção os pinos positivos e negativos antes de ligar os cabos.

PWRBTN (Botão de alimentação):

Ligue ao botão de alimentação no painel frontal do chassis. Pode configurar a forma para desligar o seu sistema através do botão de alimentação.

RESET (Botão de reposição):

Ligue ao botão de reposição no painel frontal do chassis. Prima o botão de reposição para reiniciar o computador caso este bloqueie e não seja possível reiniciar normalmente.

PLED (LED de alimentação do sistema):

Ligue ao indicador do estado da alimentação no painel frontal do chassis. O LED ficará acesso quando o sistema estiver em funcionamento. O LED ficará intermitente quando o sistema estiver no estado de suspensão S1/S3. O LED ficará desligado quando o sistema estiver nos estados de suspensão S4 ou desligado (S5).

HDLED (LED de actividade do disco rígido):

Ligue ao LED de actividade do disco rígido no painel frontal do chassis. O LED ficará acesso quando o disco rígido estiver a ler ou a escrever dados.

O design do painel frontal poderá variar dependendo do chassis. Um módulo de painel frontal consiste principalmente em um botão de alimentação, um botão de reposição, um LED de alimentação, um LED de actividade do disco rígido, um altifalante, etc. Ao ligar o seu módulo de painel frontal do chassis a este conector, certifique-se que os fios e os pinos têm uma correspondência exacta.

Conector do alto-falante
do chassis

(SPEAKER1 de 4 pinos)
(veja a folha 2, No. 16)

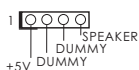

Ligue o alto-falante do chassis
neste conector.

Conector do LED de alimentação

(PLED1 de 3 pinos)

(veja a folha 2, No. 17)



Ligue o LED de alimentação do chassis a este conector para indicar o estado de alimentação do sistema. O LED ficará aceso quando o sistema estiver em funcionamento. O LED fica intermitente no estado S1/S3. O LED fica desligado nos estados S4 ou no estado S5 (desligado).

Conector do ventilador do chassis/energia

(CHA_FAN1 de 4 pinos)

(veja a folha 2, No. 22)



(CHA_FAN2 de 3 pinos)

(veja a folha 2, No. 35)

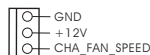

(PWR_FAN1 de 3 pinos)

(veja a folha 2, No. 2)



Ligue o cabo do ventilador neste conector, coincidindo o fio preto com o pino de aterramento. CHA_FAN1 e CHA_FAN2 suportam a função de Controlo de Ventoinha.

Conector do ventilador da CPU

(CPU_FAN1 de 4 pinos)

(veja a folha 2, No. 3)

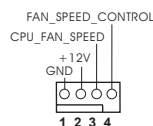

Ligue o cabo do ventilador da CPU, coincidindo o fio preto com o pino de aterramento.



Apesar de esta placa-mãe possuir 4 apoios para uma ventoinha de CPU (Ventoinha silenciosa), uma ventoinha de 3 pinos para CPU poderá funcionar mesmo sem a função de controlo de velocidade da ventoinha. Se pretender ligar uma ventoinha de 3 pinos para CPU ao conector de ventoinha do CPU nesta placa-mãe, por favor, ligue-a aos pinos 1-3.

Pinos 1-3 ligados

Instalação de Ventoinha de 3 pinos

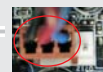

(CPU_FAN2 de 3 pinos)

(veja a folha 2, No. 1)

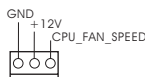

Conector de força do ATX
(ATXPWR1 de 24 pinos)
(veja a folha 2, No. 8)

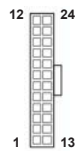

Ligue a fonte de alimentação ATX neste conector.



Embora esta placa-mãe providencie um conector de energia ATX de 24 pinos, pode apesar disso funcionar com a adaptação de uma fonte de energia tradicional de 20 pinos. Para usar a fonte de alimentação de 29 pinos, por favor ligue a sua fonte de alimentação com o Pino 1 e o Pino 13.

Instalação da Fonte de alimentação ATX de 20 Pinos

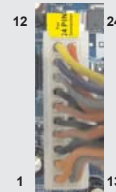

Conector de força do ATX 12V
(ATX12V1 de 8 pinos)
(veja a folha 2, No. 4)



Ligue a fonte de alimentação ATX 12V neste conector.



Embora esta placa-mãe providencie um conector de energia ATX 12V de 8 pinos, pode apesar disso funcionar com a adaptação de uma fonte de energia tradicional de 4 pinos. Para usar a fonte de alimentação de 4 pinos, por favor ligue a sua fonte de alimentação com o Pino 1 e o Pino 5.

Instalação da Fonte de alimentação ATX 12V de 4 Pinos



Conector de porta de série
(COM1 de 9 pinos)
(veja a folha 2, No. 27)

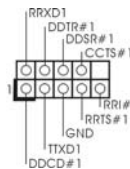

Este conector COM1 suporta um módulo de porta de série.

Conector HDMI_SPDIF
(HDMI_SPDIF1 de 2 pinos)
(veja a folha 2, No. 34)



O conector HDMI_SPDIF, que oferece saída de áudio SPDIF para placas VGA HDMI, permite ligar televisores digitais/ projectores/LCD com entrada HDMI ao sistema. Ligue o conector HDMI_SPDIF da placa VGA HDMI a este conector.

2. Informações da BIOS

O Utilitário de Configuração do BIOS está armazenado no chip FWH do BIOS. Ao iniciar o computador, pressione <F2> ou durante o Autoteste de iniciação (POST) para acessar o Utilitário de Configuração do BIOS; caso contrário, o POST continuará com as rotinas de teste. Se desejar acessar o Utilitário de Configuração do BIOS depois do POST, reinicie o sistema pressionando <Ctl> + <Alt> + , ou pressionando o botão de reinício no chassi do sistema. Para as informações detalhadas sobre o Utilitário de Configuração do BIOS, consulte o Manual do Usuário (arquivo PDF) no CD de suporte.

3. Informações do CD de Suporte

Esta placa Mãe suporta vários sistemas operacionais: Microsoft® Windows®: 7 / 7 de 64 bits / Vista™ / Vista™ de 64 bits / XP / XP de 64 bits. O CD de instalação que acompanha a placa Mãe contém: drivers e utilitários necessários para um melhor desempenho da placa Mãe. Para começar a usar o CD de instalação, introduza o CD na leitora de CD-ROM do computador. Automaticamente iniciará o menu principal, caso o AUTORUN esteja ativado. Se o menu principal não aparecer automaticamente, explore o CD e execute o "ASSETUP.EXE" localizado na pasta BIN.

1. Giriş

ASRock'ın kesintisiz titiz kalite denetimi altında üretilen güvenilir bir anakart olan ASRock **Z77 Pro4-M** anakartını satın aldığınız için teşekkür ederiz. ASRock'ın kalite ve dayanıklılık konusundaki kararlılığına uygun güçlü tasarımıyla mükemmel bir performans sunar.

Bu Hızlı Takma Kılavuzu anakarta giriş ve adım adım takma kılavuzu içerir. Anakart hakkında daha ayrıntılı bilgiyi Destek CD'sinde sunulan kullanıcı kılavuzunda bulabilirsiniz.



Anakart özellikleri ve BIOS yazılımı güncelleştirilebileceğinden bu kılavuzun içeriği önceden haber verilmeksizin değişebilir. Bu belgede değişiklik yapılması durumunda, güncelleştirilmiş sürüm ayrıca haber verilmeksizin ASRock web sitesinde sunulur. En son VGA kartlarını ve CPU destek listelerini de ASRock web sitesinde bulabilirsiniz. ASRock web sitesi <http://www.asrock.com>
Bu anakartla ilgili teknik desteğe ihtiyacınız olursa, kullandığınız modele özel bilgiler için lütfen web sitemizi ziyaret edin.
www.asrock.com/support/index.asp

1.1 Paket İçindekiler

ASRock **Z77 Pro4-M** Anakart

(Mikro ATX Form Faktörü: 9,6-inç x 9,6-inç, 24,4 cm x 24,4 cm)

ASRock **Z77 Pro4-M** Hızlı Takma Kılavuzu

ASRock **Z77 Pro4-M** Destek CD'si

2 x Seri ATA (SATA) Veri Kablosu (İsteğe Bağlı)

1 x G/Ç Panel Kalkanı



ASRock Size Şunu Hatırlatır...

Windows® 7 / 7 64-bit / Vista™ / Vista™ 64-bit ile daha iyi performans elde etmek için, Depolama Konfigürasyonundaki BIOS seçeneğini AHCI moduna ayarlamanız tavsiye edilir. BIOS ayarı için, ayrıntıları öğrenmek üzere lütfen destek CD'mizdeki "Kullanıcı Kılavuzu"na bakın.

1.2 Özellikler

Platform	- Mikro ATX Form Faktörü: 9,6-inç x 9,6-inç, 24,4 cm x 24,4 cm - Tüm Katı Kapasitör tasarımı (%100 Japon malı yüksek kaliteli İletken Polimer Kapasitörler)
CPU	- LGA1155 Paketi'deki 3. ve 2. Nesil Intel® Core™ i7 / i5 / i3'yi destekler - Digi Güç Tasarımı - 4 + 2 Güç Fazı Tasarımı - Intel® Turbo Boost 2.0 Teknolojisini destekler - K-Serisi kilidi kaldırılmış işlemciyi destekler - Hyper-Threading Teknolojisini destekler (bkz. DİKKAT 1) - Intel® Ivy Bridge İşlemci ile Intel® Rapid Start Teknolojisini ve Smart Connect Teknolojisi'ni destekler
Yonga seti	- Intel® Z77
Bellek	- Çift Kanallı DDR3 Belleği Teknolojisi (bkz. DİKKAT 2) - 4 x DDR3 DIMM yuva - DDR3 2800+(OC)/2400(OC)/2133(OC)/1866(OC)/1600/1333/1066 ECC olmayan, ara belleksiz bellek - Sistem belleğinin maks. kapasitesi: 32 GB (bkz. DİKKAT 3) - Intel® Extreme Bellek Profilini (XMP)1.3/1.2 destekler
Genişletme Yuvası	- 1 x PCI Express 3.0 x16 yuva (PCI E1: x16 modu) (bkz. DİKKAT 4) * PCI E 3.0, sadece Intel® Ivy Köprü İşlemcisiyle desteklenir. Intel® Sandy Köprü İşlemciyle, sadece PCI E 2.0'ı destekler. - 2 x PCI Express 2.0 x16 yuva (PCI E3: x1 modu; PCI E4: x4 modu) - 1 x PCI Express 2.0 x1 yuva - AMD Quad CrossFireX™ ve CrossFireX™i destekler
Grafikler	* Intel® HD Grafik Yerleşik Görselleri ve VGA çıkışları, yalnızca GPU entegre işlemciler tarafından desteklenmektedir. - Intel® HD Graphics Dahili Görselleri: Intel® Hızlı Eşitleme Videosu 2.0, Intel® InTru™ 3D, Intel® Clear Video HD Teknolojisi, Intel® Insider™, Intel® HD Graphics 2500/4000 - Pixel Shader 5.0, Intel® Ivy Bridge işlemciye sahip DirectX 11. Pixel Shader 4.1, Intel® Sandy Bridge işlemciye sahip DirectX 10.1 - Maks. paylaşılan bellek 1760 MB (bkz. DİKKAT 5) - üç VGA 3eküo sezeneği: D-Sub, DVI-D ve HDMI (bkz. DİKKAT 6) - 60Hz'de 1920x1200'e kadar maks. çözünürlükle HDMI 1.4a Teknolojisini destekler

	<ul style="list-style-type: none"> - 60Hz'de 1920x1200'e kadar maks. zıdzınlıqlıkle DVI'ya destekler - 75Hz'de 2048x1536'ya kadar maks. zıdzınlıqlıkle D-Sub'a destekler - Auto Lip Sync, Deep Color (12bpc), HDMI ile xvYCC ve HBR'yi (Yıksek Bit Hızlı Ses) destekler (Uyumlu HDMI monitır gerekir) (bkz. DİKKAT 7) - DVI ve HDMI portlarıyla HDCP irolemini destekler - DVI ve HDMI portlarıyla Tam HD 1080p Blu-ray (BD) / HD-DVD oynatımına destekler
Ses	<ul style="list-style-type: none"> - İçerik Korunmalı (Realtek ALC892 Ses Codec'i) 7,1 Kanal HD Ses - Premium Blu-ray ses desteđi - THX TruStudio™ desteđi
LAN	<ul style="list-style-type: none"> - PCIE x1 Gigabit LAN 10/100/1000 Mb/sn - Realtek RTL8111E - LAN'da Uyan özelliđini destekler - LAN Kablo Algılama'yı destekler - Enerji Verimli Ethernet 802.3az desteđi - PXE'yi destekler
Arka Panel G/3	<p>G/3 Paneli</p> <ul style="list-style-type: none"> - 1 x PS/2 Klavye Portu - 1 x D-Sub Portu - 1 x DVI-D Portu - 1 x HDMI Portu - 1 x Optik SPDIF Зэккккк Portu - 4 x Kullanım Hazır USB 2.0 Portu - 1 x eSATA3 Konektır - 2 x Kullanım Hazır USB 3.0 Portu - 1 x RJ-45 LAN Portu, LED'li (AKT/LÖNK LED'i ve HIZ LED'i) - HD Ses Jakı: Arka Hoparlör / Orta / Bas / Hat Girişı / Ön Hoparlör / Mikrofon (bkz. DİKKAT 8)
SATA3	<ul style="list-style-type: none"> - 2 x SATA3 6,0Gb/sn Intel® Z77 konektör, donanım RAID (RAID 0, RAID 1, RAID 5, RAID 10, Intel Rapid Storage ve Intel Smart Response Teknolojisini), NCQ, AHCI ve "Sistem Açıkken Bileşen Takma" işlevlerini - 2 x SATA3 6,0Gb/sn ASMedia ASM1061 konektör, donanım NCQ, AHCI ve "Sistem Açıkken Bileşen Takma" işlevlerini (SATA3_A1 konektörü eSATA3 portuyla paylaşılır)
USB 3.0	<ul style="list-style-type: none"> - 2 x Arka USB 3.0 bağlantı noktası, 5Gb/s'ye kadar USB 1.0/2.0/3.0

	<ul style="list-style-type: none"> - 1 x Ön USB 3.0 bağlantısı (2 USB 3.0 bağlantı noktasını destekler), 5Gb/s'ye kadar USB 1.0/2.0/3.0
Konektör	<ul style="list-style-type: none"> - 4 x SATA2 3,0Gb/sn, donanım RAID (RAID 0, RAID 1, RAID 5, RAID 10, Intel Rapid Storage ve Intel Smart Response Teknolojisini), NCQ, AHCI ve "Sistem Açıkken Bileşen Takma" işlevlerini - 4 x SATA3 6.0 Gb/sn konektör - 1 x KÖ fişi - 1 x Kullanıcı Kızılötesi Modül Bağlantısı - 1 x Yazdırma Portu fişi - 1 x COM portu fişi - 1 x HDMI_SPDIF fişi - 1 x Güç LED'i fişi - CPU/Kasa/Güç FAN konektörü - 24 pin ATX güç konektörü - 8 pin 12V güç konektörü - Ön panel ses konektörü - 3 x USB 2.0 fiş (6 USB 2.0 portu destekler) - 1 x USB 3.0 fiş (2 USB 3.0 portu destekler)
BIOS Özelliği	<ul style="list-style-type: none"> - 64 Mb GUI destekli AMI UEFI Geçerli BIOS - "Tak Çalıştır"ı destekler - ACPI 1.1 Uyumlu Uyandırma Olayları - Jumpersız ayarlamayı destekler - SMBIOS 2.3.1 Desteği - CPU Core, iGPU, DRAM, 1.8V PLL, VTT, VCCSA Voltaj Çoklu ayarı
Destek CD'si	<ul style="list-style-type: none"> - Sürücüler, Yardımcı Programlar, AntiVirüs Yazılımı (Deneme Sürümü), CyberLink MediaEspresso 6.5 Deneme Sürümü, ASRock MAGIX Multimedia Seti - OEM
Benzersiz Özellik	<ul style="list-style-type: none"> - ASRock Extreme Tuning Utility (AXTU) (bkz. DİKKAT 9) - ASRock Anında Önyükleme - ASRock Anında Flash (bkz. DİKKAT 10) - ASRock APP Charger (bkz. DİKKAT 11) - ASRock SmartView (bkz. DİKKAT 12) - ASRock XFast USB (bkz. DİKKAT 13) - ASRock XFast LAN (bkz. DİKKAT 14) - ASRock XFast RAM (bkz. DİKKAT 15) - ASRock Crashless BIOS (bkz. DİKKAT 16) - ASRock OMG (Online Management Guard) (bkz. DİKKAT 17) - Lucid Virtu Universal MVP (bkz. DİKKAT 18) * Lucid Virtu Universal MVP, yalnızca GPU entegre işlemciler tarafından desteklenmektedir.

	<ul style="list-style-type: none"> - ASRock Açık/Kapalı Çalma Teknolojisi (bkz. DİKKAT 19) - Hibrit Yükseltici: <ul style="list-style-type: none"> - CPU Frekans Adımsız Kontrol (bkz. DİKKAT 20) - ASRock U-COP (bkz. DİKKAT 21) - Önyükleme Hatası Koruması (B.F.G.) - Kombo Soğutucu Seçeneği (C.C.O.) (bkz. DİKKAT 22) - İyi Geceler LED'i
Donanım Monitör	<ul style="list-style-type: none"> - CPU Sıcaklık Duyarlılığı - Kasa Sıcaklık Duyarlılığı - CPU/Kasa/Güç Fan Takometresi - İşlemci/Kasa Sessiz Fanı (Kasa Fan Hızı'nın İşlemci sıcaklığı ile Otomatik Ayar'ına izin verir) - CPU/Kasa Fan Çoklu-Hız Kontrolü - Voltaj İzleme: +12V, +5V, +3,3V, CPU Vcore
İS	<ul style="list-style-type: none"> - Microsoft® Windows® 7 / 7 64-bit / Vista™ / Vista™ 64-bit / XP / XP 64-bit uyumlu (bkz. DİKKAT 23)
Sertifikalar	<ul style="list-style-type: none"> - FCC, CE, WHQL - ErP/EuP Hazır (ErP/EuP hazır güç kaynağı gerekli) (bkz. DİKKAT 24)

* Ayrıntılı ürün bilgileri için lütfen web sitemizi ziyaret edin: <http://www.asrock.com>

UYARI

Lütfen, ayarı BIOS'da ayarlama, Untied Overclocking Teknolojisi'ni uygulama veya üçüncü taraf aşırı hızlandırma araçlarını kullanma gibi durumlarda aşırı hızlandırmayla ilgili risk olduğunu unutmayın. Aşırı hızlandırma sisteminizin kararlılığını etkiler veya hatta sisteminizin bileşenlerini ve cihazlarına zarar verebilir. Bu risk size aittir ve zararı siz ödersiniz. Aşırı hızlandırmadan kaynaklanan olası zarardan sorumlu değiliz.

DİKKAT!

1. "Hyper Threading Teknolojisi" ayarı hakkında lütfen destek CD'sindeki "Kullanıcı Kılavuzu"nda sayfa 52'ye bakın.
2. Bu anakart Çift Kanallı Bellek Teknolojisi'ni destekler. Çift Kanallı Bellek Teknolojisi'ni uygulamadan önce, uygun yükleme hakkında sayfa 17'teki bellek modüllerinin yükleme kılavuzunu okuduğunuzdan emin olun.
3. İşletim sistemi kısıtlaması nedeniyle, Windows® 7 / Vista™ / XP altında sistem kullanımı için ayırmak için gerçek bellek boyutu 4 GB'den az olabilir. 64-bit CPU'lu Windows® OS için bu tür bir sınırlama yoktur. Windows®'un kullanamadığı bellekten yararlanmak için ASRock XFast RAM'i kullanabilirsiniz.
4. Sadece PCIE1 yuvası, Gen 3 hızına kadar destekler. PCI Express kartı, Gen 3 hızında çalıştırmak için, lütfen Ivy Köprü İşlemcisini yükleyin. Sandy Köprü İşlemcisini yüklemek isterseniz, PCI Express kartı sadece PCI Express Gen 2 hızında çalışacaktır.

5. Maksimum paylaşılan bellek boyutu yonga seti satıcısı tarafından tanımlanır ve değişebilir. Lütfen en son bilgileri için Intel® web sitesini kontrol edin.
6. Bazı monitörlerden yalnızca ikisini kullanmaya sezebilirsiniz. D-Sub, DVI-D ve HDMI monitörler aynı anda etkinleştirilemez. Ayrıca, DVI - HDMI adaptörüyle, DVI-D portu HDMI portu ile aynı özellikleri destekleyebilir.
7. xvYCC ve Deep Color yalnızca Windows® 7 64-bit / 7'de desteklenir. Deep Color modu yalnızca ekran EDID'de 12bpc'yi desteklerse etkinleştirilecektir. HBR Windows® 7 64-bit / 7 / Vista™ 64-bit / Vista™ altında desteklenir.
8. Mikrofon çıkışı için, bu anakart hem stereo hem de mono modlarını destekler. Ses çıkışı için, bu anakart 2 kanallı, 4 kanallı, 6 kanallı ve 8 kanallı modları destekler. Düzgün bağlantı için sayfa 3'teki tabloyu kontrol edin.
9. ASRock Extreme Tuning Utility (AXTU) hepsi bir arada bir araç olup kullanıcı ile dost bir arayüzde farklı sistem işlevlerinin ince ayarını yapmak için kullanılmakta olup buna Donanım Monitörü, Fan Kontrolü, Hız Aşırı, OC DNA ve IES dahildir. Donanım Monitöründe sisteminizde okunan önemli değerleri gösterir. Fan Kontrolünde ayarlarınız için fan hızını ve sıcaklığını gösterir. Hız aşırı, optimum sistem performansı almak için CPU frekansını hız aşırı yapmanıza izin verilmiştir. OC DNA'da OC ayarlarınızı bir profil olarak kaydedebilir ve arkadaşlarınız ile paylaşabilirsiniz. Ardından arkadaşlarınız OC profilini kendi sistemine ekleyerek aynı OC ayarlarını alabilir. IES'de (Akıllı Enerji Tasarrufu), CPU çekirdekleri boşta olduğunda bilgisayarın performansından ödün vermeden gerilim düzenleyicisi çıkış fazlarının sayısını düşürerek verimliliği iyileştirir. ASRock Extreme Tuning Utility (AXTU)'nun çalışma prosedürleri için lütfen web sitemizi ziyaret ediniz.
ASRock web sitesi: <http://www.asrock.com>
10. ASRock Anında Flash, Flash ROM'a katıştırılmış bir BIOS flash yardımcı programıdır. Bu kullanışlı BIOS güncelleme aracı, sistem BIOS'unu MS-DOS veya Windows® gibi ilk önce işletim sistemine girmeden güncelleme menüsü sağlar. Bu yardımcı programla, POST sırasında <F6> tuşuna basabilirsiniz veya BIOS ayarları menüsünün ASRock Anında Flash'a erişmesi için <F2> tuşuna basabilirsiniz. Bu aracı başlatın ve yeni BIOS dosyasını USB flash sürücünüze, diske veya sabit sürücüye kaydedin, sonra BIOS'unuzu yalnızca birkaç tıklama ile ek bir disket veya diğer karmaşık flash yardımcı programlarını hazırlamadan güncelleyebilirsiniz. Lütfen USB flash sürücünün veya sabit diskin FAT32/16/12 dosya sistemi kullanması gerektiğini unutmayın.
11. iPhone/iPad/iPod Touch gibi Apple cihazlarınızı şarj etmek için daha hızlı ve daha özgür bir biçimde şarj etmek istiyorsanız, ASRock sizin için mükemmel bir çözüm hazırladı - ASRock APP Charger. Sadece APP Charger sürücünü kurarak, iPhone'unuzu bilgisayarınızdan daha çabuk ve eskisinden 40% daha hızlı şekilde şarj edebilirsiniz. ASRock APP Charger birçok Apple cihazını aynı anda ve hızlı bir biçimde şarj etmenize olanak tanır ve hatta bilgisayarınız Bekleme modunda (S1), RAM'de Askıya Al

modunda (S3), uyku modunda (S4) veya kapalı(S5) iken sürekli şarj etmeyi destekler. APP Charger sürücüsü kurulu iken kolaylıkla şimdide hiç olmadığı kadar harika bir şarj deneyimi yaşayabilirsiniz.

ASRock internet sitesi: <http://www.asrock.com/Feature/AppCharger/index.asp>

12. İnternet tarayıcısının yeni bir işlevi olan SmartView, en sık ziyaret ettiğiniz web sitelerini, geçmişinizi, Facebook arkadaşlarınızı ve sizin gerçek zamanlı haber beslemelerinizi, daha kişisel bir İnternet deneyimi için geliştirilmiş bir görünümde birleştiren IE için akıllı başlangıç sayfasıdır. ASRock anakartları, hareket halindeki arkadaşlarınızla irtibat halinde kalmanıza yardım eden SmartView yardımcı programı ile donatılmıştır. SmartView özelliğini kullanmak için işletim sistemi sürümünüzün Windows® 7 / 7 64 bit / Vista™ / Vista™ 64 bit, ve tarayıcı sürümünüzün IE8 olmasına dikkat edin. ASRock web sitesi: <http://www.asrock.com/Feature/SmartView/index.asp>
13. ASRock XFast USB, USB bellek aygıtı performansını arttırabilir. Performans aygıtının özelliğine göre değişiklik gösterebilir.
14. ASRock XFast LAN hızlı internet erişimi sağlarken aşağıdaki avantajlara da sahiptir. LAN uygulaması Önceliklendirmesi: Uygulama önceliğinizi ideal şekilde yapılandırabilir ve/veya yeni programlar ekleyebilirsiniz. Oyunda Daha Az Gecikme Zamanı: Çevrimiçi oyun önceliğini daha yükseğe ayarladığınızda, oyundaki gecikmeler azalabilir. Trafik Şekillendirme: Youtube HD video izleyebilir ve aynı anda dosyaları indirebilirsiniz. Verilerinizin Gerçek Zamanlı Analizi: Durum penceresi ile, şu anda aktardığınız hangi verilerin akışının yapıldığını kolaylıkla yapılandırabilirsiniz.
15. ASRock XFast RAM, ASRock Extreme Tuning Utility'ye (AXTU) eklenen yeni bir işlev. Windows® 32-bit işletim sistemi CPU'su altında kullanılmayan bellek alanından tamamen yararlanır. ASRock XFast RAM webde sörfü şimdide kadar olmadığı kadar hızlandırırken önceden ziyaret edilen web sitelerinin yüklenme süresini kısaltır. Ayrıca Adobe Photoshop'ın hızını 5 kat arttırır. ASRock XFast RAM'in başka bir avantajı da, SSD veya HDD'lerinize erişim sıklığını azaltarak kullanım ömürlerini uzatması.
16. ASRock Crashless BIOS kullanıcıların arıza çıkma korkusu olmadan BIOS'larını güncellemesine imkan verir. BIOS güncelleme işlemi sırasında güç kaybı yaşanırsa, ASRock Crashless BIOS güç geri geldiğinde BIOS güncelleme işlemini otomatik olarak tamamlayacaktır. Lütfen, BIOS dosyalarının USB diskinizin kök dizinine yerleştirilmesi gerektiğini unutmayın. Bu özelliği yalnızca USB2.0 bağlantı noktaları desteklemektedir.
17. Yöneticiler, OMG aracılığıyla bir internet yasaklı saat uygulaması oluşturabilir ya da belirli zamanlarda internete erişimi sınırlandırabilirler. [Her gün], [Haftanın günü] veya [Haftaiçi ve haftasonları]'dan birini seçebilir, daha sonra diğer kullanıcıların internet erişimi iznin başlangıç ve bitiş saatlerini programlayabilirsiniz. Kullanıcıların OMG'yi atlamalarını önlemek için, sistem saatinde değişiklik yapma izni bulunmayan konuk hesapları gereklidir.

18. VIRTU Universal MVP, mükemmel tütme işlevi için bütünleşik GPU ve ayrı GPU'yu sanallaştıran Virtu Universal teknolojisinin temel özelliklerini içermektedir. Rakipsiz görsel kalite için Virtual Vsync™ özelliğine de sahiptir. HyperFormance teknolojisinin artırılan faydaları ile, VIRTU Universal MVP İşlemci, GPU ve ekran arasındaki akışta bulunan gereksiz yere sunulan görevleri akıllı bir şekilde azaltarak oyun performansını yükseltir.
19. ASRock Açık/Kapalı Çalma Teknolojisi kullanıcıların bilgisayar kapalıyken (veya ACPI S5 modundayken) bile bilgisayara bağlı MP3 çalar, cep telefonu gibi taşınabilir ses aygıtlarında mükemmel ses deneyiminin keyfini çıkarmalarına izin verir! Bu ana kart aynı zamanda kullanıcılar için en elverişli bilgisayar kullanım ortamını sunan ücretsiz 3,5mm ses kablosu (isteğe bağlı) sağlamaktadır.
20. Bu anakart adımsız kontrole izin verse de aşırı hızlandırma uygulamanız önerilmez. Önerilen CPU veri yolu frekansları dışındaki frekanslar sistemin dengesiz olmasına veya CPU'nun zarar görmesine neden olabilir.
21. CPU aşırı ısınması algılandığında, sistem otomatik olarak kapatılır. Sistemi devam ettirmeden önce, lütfen anakarttaki CPU fanının düzgün çalıştığını kontrol edin ve güç kablosunu çıkarın, sonra geri takın. Isı geçişini artırmak için, PC sisteminizi yüklediğinizde CPU ile ısı emici arasına ısı macunu sürmeyi unutmayın.
22. Kombo Soğutucu Seçeneği (C.C.O.) üç farklı CPU soğutucu tipi olan Soket LGA 775, LGA 1155 ve LGA 1156'yı çalıştıracak esnek seçeneğe sahiptir. Lütfen tüm 775 ve 1156 CPU Fanlarının kullanılmayacağını unutmayın.
23. ASRock XFast RAM, Microsoft® Windows® XP / XP 64-bit ile uyumlu değildir. Intel® Smart Connect Teknolojisini ve Intel® USB 3.0 portu, Microsoft® Windows® Vista™ / Vista™ 64-bit / XP / XP 64-bit ile uyumlu değildir.
24. Enerji Kullanan Ürün anlamına gelen EuP, tamamlanmış sistemler için güç tüketimini tanımlamak için Avrupa Birliği tarafından düzenlenen bir gerekliliktir. EuP'a göre, kapalı mod durumunda tamamlanmış sistemin toplam AC gücü 1,00W altında olmalıdır. EuP standardını karşılamak için, EuP hazır anakart ve EuP hazır güç kaynağı gerekir. Intel'in önerisine göre, EuP hazır güç kaynağının 100 mA akım tüketiminde 5v beklemede güç etkinliği %50'den yüksektir standardını karşılaması gerekir. EuP hazır güç kaynağı seçimi için, daha fazla ayrıntı için güç kaynağı üreticisine başvurmanızı öneririz.

1.3 Jumper'ların Ayarı

Şekilde jumper'ların nasıl ayarlandıkları gösterilmektedir. Jumper kapağı pinler üzerine yerleştirildiğinde jumper "Kapalı" dır. Jumper kapağı pinler üzerindeyken jumper "Açık" tır. Şekilde pin1 ve pin2'si "Kapalı" olan jumper kapağı bu 2 pine yerleştirilmiş 3-pinli jumper gösterilmektedir.

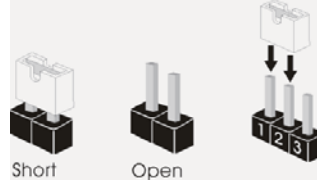

Jumper

Ayar

CMOS'u temizleme

(CLRCMOS1, 3-pinli jumper)

(bkz. s.2 No. 15)



Default



Clear CMOS

Not: CLRCMOS1, CMOS'daki verilerinizi temizlemenize olanak sağlar. Sistem parametrelerini temizlemek ve varsayılan ayara sıfırlamak için lütfen bilgisayarı kapatın ve güç kablosunun fişini güç kaynağından çekin. 15 saniye bekledikten sonra, pin2 ve pin3'ü CLRCMOS1'de 5 saniye kısaltmak için bir atlatıcı şapkası kullanın. Ancak, BIOS'u güncelledikten hemen sonra lütfen CMOS'u temizlemeyin. BIOS'u güncellemeyi tamamladığınızda CMOS'u temizlemeniz gerekirse, ilk olarak sistemi başlatmanız ve ardından CMOS temizleme işlemini gerçekleştirmeden önce kapatmanız gereklidir. Parola, tarih, saat, kullanıcı varsayılan profili, 1394 GUID ve MAC adresinin yalnızca CMOS pili çıkarıldığında temizleneceğini lütfen aklınızda bulundurunuz.

1.4 Yerleşik Fişler ve Konektörler

Yerleşik fişler ve konektörler jumper DEĞİLDİR. Bu fişlerin ve konektörlerin üzerine jumper kapakları YERLEŞTİRMEYİN. Fişlerin ve konektörlerin üzerine jumper kapakları yerleştirmek anakartın kalıcı olarak zarar görmesine neden olabilir!

Seri ATA2 Konektörler

(SATA2_2_3: bkz. s.2, No. 14)

(SATA2_4: bkz. s.2, No. 21)

(SATA2_5: bkz. s.2, No. 20)

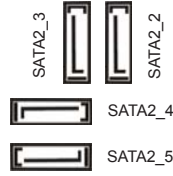

Bu dört Seri ATA2 (SATA2) konektör, dahili depolama cihazları için SATA veri kablolarını destekler. Geçerli SATA2 arayüzü 3,0 Gb/sn veri aktarım hızına izin verir.

Seri ATA3 Konektörler

(SATA3_A0_A1: bkz. s.2, No. 12)

(SATA3_0_1: bkz. s.2, No. 13)

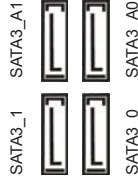

Bu dört Seri ATA3 (SATA3) konektör, dahili depolama cihazları için SATA veri kablolarını destekler. Geçerli SATA3 arayüzü 6,0 Gb/sn veri aktarım hızına izin verir. Arka G/Ç'deki eSATA3 bağlantı noktasında bağlantı varsa, iç SATA3_A1 çalışmayacaktır.

Seri ATA (SATA)

Veri Kablosu

(İsteğe bağlı)



SATA veri kablosunu her iki ucu da SATA / SATA2 / SATA3 sabit diskinde veya anakarttaki SATA2 / SATA3 konektörüne bağlanabilir.

Yazdırma Portu Fişi

(25-pinli LPT1)

(bkz. s.2 No. 28)

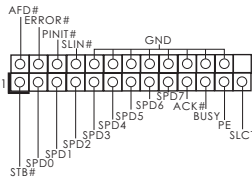

Bu, yazdırma portu kablosu için yazıcı cihazlarının uygun bağlanmasını sağlayan bir arayüzdür.

Türkçe

USB 2.0 Fişleri

(9-pinli USB_6_7)
(bkz. s.2 No. 25)

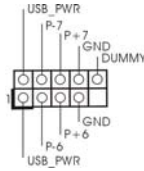

G/Ç panelindeki varsayılan dört USB 2.0 portundan başka, bu anakartta üç USB 2.0 fişi bulunur. Her USB 2.0 fişi iki USB 2.0 portunu destekler.

(9-pinli USB_8_9)
(bkz. s.2 No. 24)

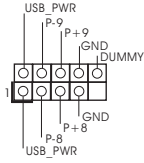

(9-pinli USB_10_11)
(bkz. s.2 No. 23)

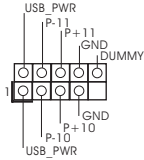
**USB 3.0 Fişleri**

(19-pinli USB3_12_13)
(bkz. s.2 No. 9)

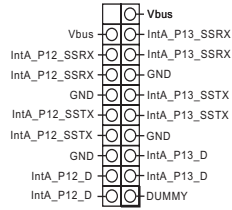

I/O panelinde bulunan iki adet varsayılan USB 3.0 bağlantı noktasının yanı sıra, bu ana kart üzerinde bir adet USB 3.0 bağlantısı bulunur. Bu USB 3.0 bağlantısı iki adet USB 3.0 bağlantı noktasını destekleyebilir.

Kızılötesi Modülü Fişi

(5-pinli IR1)
(bkz. s.2 No. 19)

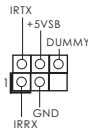

Bu fiş, isteğe bağlı bir kablosuz aktarma ve alma kızılötesi modülünü destekler.

Kullanıcı Kızılötesi Modül Bağlantısı

(4-pinli CIR1)
(bkz. s.2 No. 26)



Bu fiş, uzaktan kumanda alıcısı destekler.

Ön Panel Ses Fişi

(9-pinli HD_AUDIO1)

(bkz. s.2 No. 33)

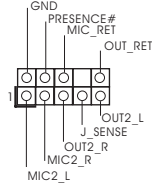

Bu, panel ses kablosu için uygun bağlantı sağlayan ve ses cihazlarını kontrol etmeyi sağlayan bir arayüzdür.



1. Yüksek Tanımlı Ses Jak Duyarlılığını destekler, ancak kasadaki panel kablosunun HDA'nın düzgün çalışmasını desteklemesi gerekir. Lütfen sisteminizi yüklemek için kılavuzumuzdaki ve kasa kılavuzundaki talimatları izleyin.

2. AC'97 ses paneli kullanıyorsanız, lütfen ön panel ses fişine aşağıdaki gibi takın:

- A. Mic_IN'i (MIC) MIC2_L'ye bağlayın.
- B. Audio_R'yi (RIN) OUT2_R'ye ve Audio_L'yi (LIN) OUT2_L'ye bağlayın.
- C. Ground'u (GND) Ground'a (GND) bağlayın.
- D. MIC_RET ve OUT_RET yalnızca HD ses paneli içindir. Bunları AC'97 ses paneli için bağlamanız gerekmez.
- E. Ön mikrofonu etkinleştirmek için

Windows® XP / XP 64-bit İS için:

"Karıştırıcı"yı seçin. "Kaydedici"yi seçin. Sonra "Ön Mikrofon"u tıklatın.

Windows® 7 / 7 64-bit / Vista™ / Vista™ 64-bit İS için:

Realtek Kontrol panelinde "Ön Mikrofon" Sekmesine gidin. "Kayıt Ses Seviyesi"ni ayarlayın.

Sistem Paneli Fişi

(9-pinli PANEL1)

(bkz. s.2 No. 20)

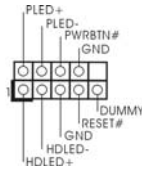

Bu fiş, birçok sistem ön paneli işlevini barındırır.



Kasa üzerindeki güç anahtarını, sıfırlama anahtarını ve sistem durumu göstergesini aşağıdaki pin atamalarına göre bu bağlantıya bağlayın. Kabloları bağlamadan önce pozitif ve negatif pinlere dikkat edin.

PWRBTN (Güç Anahtarı):

Kasa üzerindeki güç anahtarını ön panele bağlayın. Güç anahtarını kullanarak sisteminizi kapatma şeklinizi yapılandırabilirsiniz.

RESET (Sıfırlama Anahtarı):

Kasa üzerindeki sıfırlama anahtarını ön panele bağlayın. Bilgisayar donarsa veya normal bir yeniden başlatma gerçekleştirilemezse, bilgisayarı yeniden başlatmak için sıfırlama anahtarına basın.

Türkçe

PLED (Sistem Gücü LED'i):

Kasa üzerindeki güç durumu göstergesini ön panele bağlayın. Sistem çalışırken LED yanar. Sistem S1/S3 uyku modunda iken LED yanıp sönmeye devam eder. Sistem S4 uyku modunda veya kapalı (S5) iken LED söner.

HDLED (Sabit Disk Çalışma LED'i):

Kasa üzerindeki sabit disk çalışma LED'ini ön panele bağlayın. Sabit disk veri okurken veya yazarken LED yanar.

Ön panel tasarımı kasaya göre değişiklik gösterebilir. Ön panel modülünde temel olarak güç anahtarı, sıfırlama anahtarı, güç LED'i, sabit disk çalışma LED'i, hoparlör vb. bulunur. Kasa ön panel modülünüzü bu bağlantıya bağlarken, kablo atamalarının ve pin atamalarının doğru biçimde eşleştirildiğinden emin olun.

Kasa Hoparlörü Fişi

(4-pinli SPEAKER1)

(bkz. s.2 No. 16)

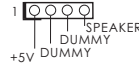

Lütfen kasa hoparlörünü bu fişe bağlayın.

Güç LED'i Fişi

(3-pinli PLED1)

(bkz. s.2 No. 17)



Sistem gücü durumunu belirtmek için lütfen kasa güç LED'ini bu fişe bağlayın. Sistem çalışırken LED açıktır. LED S1/S3 durumunda yanıp sönmeye devam eder. LED S3/S4 durumunda veya S5 durumunda da (güç kapalı) kapalıdır.

Kasa/güç Fan Konektörü

(4-pinli CHA_FAN1)

(bkz. s.2 No. 22)

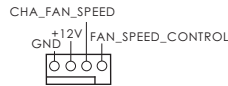

Lütfen kasa fan kablolarını fanına bu konektöre bağlayın ve siyah kabloyu toprak pinine bağlayın. CHA_FAN1 ve CHA_FAN2 destekli Fan Denetimi.

(3-pinli CHA_FAN2)

(bkz. s.2 No. 35)

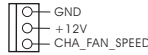

(3-pinli PWR_FAN1)

(bkz. s.2 No. 2)

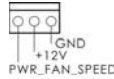

CPU Fan Konektörü

4-pinli CPU_FAN1)
(bkz. s.2 No. 3)

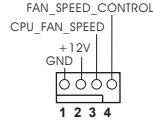

Lütfen fan kablolarını CPU fanına bu konektöre bağlayın ve siyah kabloyu toprak pinine bağlayın.



Bu anakart 4-Pinli CPU fan (Sessiz Fan) desteği sağlasa da, 3-Pinli CPU fan hızı kontrol işlevi olmadan bile hala başarılı bir şekilde çalışabilir. 3-Pinli CPU fanı bu konektördeki CPU fan konektörüne bağlamayı planlıyorsanız, lütfen Pin 1-3'e bağlayın.

Pin 1-3 Bağlı

3-Pinli Fanı Takma

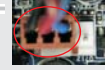

(3-pinli CPU_FAN2)
(bkz. s.2 No. 1)

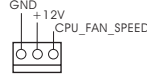

ATX Güç Konektörü

(24-pinli ATXPWR1)
(bkz. s.2 No. 8)

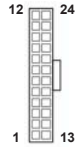

Lütfen bir ATX güç kaynağını bu konektöre bağlayın.



Bu anakart 24-pinli ATX güç konektörü sağlasa da geleneksel bir 20-pinli ATX güç kaynağı bağlarsanız da çalışabilir. 20-pinli ATX güç kaynağını kullanmak için, lütfen güç kaynağınızı Pin 1 ve Pin 13'le birlikte takın.

20-Pinli ATX Güç Kaynağını Takma

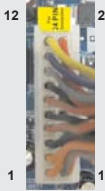

ATX 12V Güç Konektörü

(8-pinli ATX12V1)
(bkz. s.2 No. 4)



Lütfen bir ATX 12V güç kaynağını bu konektöre bağlayın.



Bu anakart 8-pinli ATX 12V güç konektörü sağlasa da geleneksel bir 4-pinli ATX 12V güç kaynağı bağlarsanız da çalışabilir. 4-pinli ATX güç kaynağını kullanmak için, lütfen güç kaynağınızı Pin 1 ve Pin 5'le birlikte takın.

4-Pinli ATX 12V Güç Kaynağını Takma



Türkçe

Seri port Fişi
(9-pinli COM1)
(bkz. s.2 No. 27)

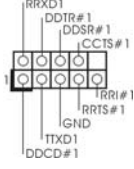

Bu COM1 fişi bir seri port modülünü destekler.

HDMI_SPDIF Fişi
(2-pinli HDMI_SPDIF1)
(bkz. s.2 No. 34)



HDMI_SPDIF fişi, SPDIF ses çıkışını HDMI VGA kartına sağlar, sistemin HDMI Dijital TV/projektör/LCD cihazlarını bağlamasına izin verir. Lütfen HDMI VGA kartının HDMI_SPDIF konektörünü bu fişe bağlayın.

2. BIOS Bilgileri

Anakarttaki Flash Bellek BIOS Ayarları Yardımcı Programını içerir. Bilgisayarı başlattığınızda, lütfen Otomatik Güç Sınaması (POST) sırasında BIOS Ayarları yardımcı programına girmek için <F2> veya tuşuna basın; aksi halde, POST test rutinlerine devam eder. BIOS Ayarlarına POST'tan sonra girmek istiyorsanız, lütfen <Ctl> + <Alt> + <Delete> tuşlarına basarak veya sistem kasaındaki sıfırlama düğmesine basarak sistemi yeniden başlatın. BIOS Ayarları programı kullanıcı dostu olacak şekilde tasarlanmıştır. Çeşitli alt menüler arasında dolaşmanıza ve önceden belirlenen seçenekler arasından seçim yapmanıza izin veren menü tabanlı bir programdır. BIOS Ayarları hakkında ayrıntılı bilgi için, lütfen Destek CD'sinde bulunan Kullanıcı Kılavuzu'na (PDF dosyası) başvurun.

3. Yazılım Destek CD'si bilgileri

Bu anakart çeşitli Microsoft® Windows® işletim sistemleri destekler: 7 / 7 64-bit / Vista™ / Vista™ 64-bit / XP / XP 64-bit. Anakartla birlikte gelen Destek CD'si anakart özelliklerini genişleten gerekli sürücüleri ve kullanışlı yardımcı programları içerir. Destek CD'sini kullanmaya başlamak için, CD'yi CDROM sürücünüze takın. Bilgisayarınızda "OTOMATİK KULLAN" özelliği etkinleştirilmişse, Ana Menü otomatik olarak görüntülenir. Ana Menü otomatik olarak görüntülenmezse, menüleri görüntülemek için Destek CD'sinin "BIN" klasöründeki "ASSETUP.EXE" dosyasını bulun ve çift tıklayın.

1. 제품소개

ASRock의 **Z77 Pro4-M** 메인 보드를 구매하여 주신것에 대하여 감사 드립니다. 이 메인보드는 엄격한 품질관리 하에 생산되어진 신뢰성 있는 메인보드입니다. 이 제품은 고 품격 디자인과 함께 ASRock의 우수한 품질과 최고의 안정성을 자랑하고 있습니다. 이 빠른 설치 안내서에는 마더보드에 대한 설명과 단계별 설치 방법이 실려 있습니다. 마더보드에 대한 보다 자세한 내용은 지원 CD의 사용 설명서에서 확인할 수 있습니다.



메인보드의 사양이나 바이오스가 업데이트 되기 때문에 이 사용자 설명서의 내용은 예고 없이 변경되거나 바뀔 수가 있습니다. 만을 생각해서 이 사용자 설명서의 어떤 변경이 있으면 ASRock의 웹 사이트에서 언제든지 업데이트를 하실 수 있습니다. 웹사이트에서 최신 VGA 카드와 CPU 지원 목록을 확인할 수 있습니다. ASRock의 웹사이트 주소는 <http://www.asrock.com>입니다.
본 마더보드와 관련하여 기술 지원이 필요한 경우 당사 웹 사이트를 방문하여 사용 중인 모델에 대한 특정 정보를 얻으십시오.
www.asrock.com/support/index.asp

1.1 패키지 내용

ASRock **Z77 Pro4-M** 마더보드
(Micro ATX 폼 팩터 : 9.6" x 9.6" , 24.4 x 24.4 cm)
ASRock **Z77 Pro4-M** 렉 설치 가이드
ASRock **Z77 Pro4-M** 지원 CD
시리얼 ATA (SATA) 데이터 케이블 2 개 (선택 사양)
I/O 차폐 1 개



ASRock은사용자에게 알립니다...

Windows®7 / 7 64-비트 / Vista™ / Vista™ 64-비트의 성능을 향상시키기 위해서 Storage Configuration(스토리지 구성)에서 BIOS 옵션을 AHCI 모드로 설정하는 것이 좋습니다. BIOS 설정과 관련하여 자세한 내용은 지원 CD에 포함된 "사용 설명서"를 참조하십시오.

1.2 설명서

플랫폼	- Micro ATX 폼 팩터 : 9.6" x 9.6" , 24.4 x 24.4 cm - 완전 교체 축전지 디자인 (100% 일본산 고품질 정도성 고분자 콘덴서)
CPU	- LGA1155 패키지에서 3 세대 및 2 세대 Intel® Core™ i7 / i5 / i3 을 지원합니다 - Digi 전원 설계 - 4 + 2 전원 위상 디자인 - Intel® Turbo Boost 2.0 기술 지원 - K- 시리즈 잠금 해제 CPU 지원 - 하이퍼 - 스레딩 기술 지원 (주의 1 참조) - Intel® Ivy Bridge CPU 에서 Intel® Rapid Start 기술과 Smart Connect 기술을 지원합니다
칩셋	- Intel® Z77
메모리	- 듀얼 채널 메모리 기술 지원 (주의 2 참조) - DDR3 DIMM 슬롯 4 개 - DDR3 2800+(OC)/2400(OC)/2133(OC)/1866(OC)/1600/1333/1066 비-ECC, 언버퍼드 메모리를 지원 - 최대 시스템 메모리 용량 : 32GB (주의 3 참조) - Intel® 익스트림 메모리 프로파일 (XMP)1.3/1.2 지원
확장 슬롯	- 1 x PCI Express 3.0 x16 슬롯 (PCI E1 : x16 모드) (주의 4 참조) * PCI E 3.0 은 Intel® Ivy Bridge CPU 에서만 지원됩니다 . Intel® Sandy Bridge CPU 는 PCI E 2.0 만 지원합니다 . - 2 개의 PCI Express 2.0 x16 슬롯 (PCI E3 : x1 모드 ; PCI E4 : x4 모드) - 1 개의 PCI Express 2.0 x1 슬롯 - AMD Quad CrossFireX™ 및 CrossFireX™ 지원
온보드 VGA	* Intel® HD Graphics 내장 비주얼 및 VGA 출력은 GPU 통합된 프로세서의 경우에만 지원됩니다 . - Intel® HD 그래픽 내장 비주얼 프로그램 : Intel® Quick Sync Video 2.0, Intel® InTru™ 3D, Intel® Clear Video HD Technology, Intel® Insider™, Intel® HD Graphics 2500/4000 - Intel® Ivy Bridge CPU 를 탑재한 DirectX 11, Pixel Shader 5.0 Intel® Sandy Bridge CPU 를 탑재한 DirectX 10.1, Pixel Shader 4.1 - 최대 공유 메모리 1760MB (주의 5 참조) - 3 개의 VGA 출력 옵션 : D-Sub, DVI-D 및 HDMI (주의 6 참조) - 최대 해상도 1920x1200 @ 60Hz 까지 HDMI 1.4a 지원 - 최대 해상도 1920x1200 @ 60Hz 까지 DVI 지원 - 최대 해상도 2048x1536 @ 75Hz 까지 D-Sub 지원

	<ul style="list-style-type: none"> - 자동 립 싱크 (Auto Lip Sync), 딥 컬러 (Deep Color)(12bpc), xvYCC, HBR(고비트율 오디오), HDMI 지원 (HDMI 호환 모니터 필요) (주의 7 참조) - DVI 및 HDMI 포트를 이용한 HDCP 기능 지원 - DVI 및 HDMI 포트를 이용한 1080p Blu-ray (BD) / HD-DVD 재생을 지원
오디오	<ul style="list-style-type: none"> - 7.1 CH HD Audio 목록 보호 (Realtek ALC892 Audio Codec) - Premium Blu-ray 오디오 지원 - THX TruStudio™ 지원
랜	<ul style="list-style-type: none"> - PCIE x1 Gigabit LAN 10/100/1000 Mb/s - Realtek RTL8111E - 웨이크 - 온 - 랜 지원 - LAN 케이블 감지 지원 - 절전형 이더넷 802.3az 지원 - PXE 지원
후면판 I/O	<p>I/O Panel</p> <ul style="list-style-type: none"> - 1 개 PS/2 키보드 포트 - 1 개의 D-Sub 포트 - 1 개의 DVI-D 포트 - 1 개의 HDMI - 1 개광학 SPDIF 출력 포트 - 4 개디폴트 USB 2.0 포트 - 1 개 eSATA3 커넥터 - 2 개디폴트 USB 3.0 포트 - 1 개 LED(ACT/LINK LED 및 SPEED LED) 가 있는 RJ-45 LAN 포트 - 오디오 잭 : 후방 스피커 / 중앙 / 저음 / 라인 인 / 전방 스피커 / 마이크 (주의 8 참조)
SATA3	<ul style="list-style-type: none"> - Intel® Z77 SATA3 6.0Gb/s 커넥터 2 개 , 하드웨어 RAID (RAID 0, RAID 1, RAID 5, RAID 10, Intel Rapid Storage 및 Intel Smart Response 기술), NCQ, AHCI 및 Hot Plug (핫플러그) 기능 지원 - ASMedia ASM1061 SATA3 6.0Gb/s 커넥터 2 개 , 하드웨어 NCQ, AHCI 및 "Hot Plug" (핫플러그) 기능 지원 (SATA3_A1 커넥터는 eSATA3 포트와공유됨)
USB 3.0	<ul style="list-style-type: none"> - 에 의한 후면 패널 USB 3.0 포트 2 개 , 최고 5Gb/s 의 USB 1.0/2.0/3.0 지원 - 에 의한 전면 패널 USB 3.0 헤더 1 개 (USB 3.0 포트 2 개 지원), 최고 5Gb/s 의 USB 1.0/2.0/3.0 지원
온보드 헤더 및 커넥터	<ul style="list-style-type: none"> - 4 개 의 SATA2 3.0Gb/s 커넥터 , RAID (RAID 0, RAID 1, RAID 5, RAID 10, Intel Rapid Storage 및 Intel Smart

	<p>Response 기술) 기능지원, NCQ, AHCI 및 “핫 플러그” 기능 지원</p> <ul style="list-style-type: none"> - 4 개의 SATA3 6.0Gb/s 커넥터 - 적외선 모듈 헤더 1 개 - 소비자용 적외선 모듈 헤더 1 개 - 프린트 포트 헤더 1 개 - COM 포트 헤더 1 개 - HDMI_SPDIF 헤더 1 개 - 전원 LED 헤더 1 개 - CPU/ 새시 / 전원 팬 커넥터 - 24 핀 ATX 전원 헤더 - 8 핀 ATX 12V 파워 콘넥터 - 전면부 오디오 콘넥터 - USB 2.0 헤더 3 개 (6 개의 추가 USB 2.0 포트를 지원하는 헤더 2 개) - USB 3.0 헤더 1 개 (2 개의 추가 USB 3.0 포트를 지원하는 헤더 2 개)
BIOS	<ul style="list-style-type: none"> - 64Mb GUI 지원을 제공하는 AMI UEFI 적합형 BIOS - “플러그 앤 플레이” 지원 - ACPI 1.1 웨이크-업 이벤트와의 호환 - 점퍼 프리 지원 - SMBIOS 2.3.1 지원 - CPU Core, IGPU, DRAM, 1.8V PLL, VTT, VCCSA 전압 멀티 조절
지원 CD	<ul style="list-style-type: none"> - 드라이버, 유틸리티, 백신 소프트웨어 (시험판), CyberLink MediaEspresso 6.5 평가판, ASRock MAGIX Multimedia Suite - OEM
특점 및 특성	<ul style="list-style-type: none"> - ASRock Extreme Tuning Utility (AXTU) (주의 9 참조) - ASRock Instant Boot - ASRock Instant Flash (주의 10 참조) - ASRock APP Charger (주의 11 참조) - ASRock SmartView (주의 12 참조) - ASRock XFast USB (주의 13 참조) - ASRock XFast LAN (주의 14 참조) - ASRock XFast RAM (주의 15 참조) - ASRock Crashless BIOS (주의 16 참조) - ASRock OMG (Online Management Guard) (주의 17 참조) - Lucid Virtu Universal MVP (주의 18 참조) * Lucid Virtu Universal MVP 는 GPU 통합된 프로세서의 경우에만 지원됩니다. - ASRock On/Off Play 기술 (주의 19 참조) - 하이브리드 부스터 :

	<ul style="list-style-type: none"> - CPU 주파수의 단계적인 조절 (주의 20 참조) - ASRock U-COP (주의 21 참조) - B.F.G.(Boot Failure Guard) - 콤보 쿨러 옵션 (C.C.O.)(주의 22 참조) - 굿나잇 LED
하드웨어 모니터	<ul style="list-style-type: none"> - CPU 온도 감지 - 마더보드 온도 감지 - CPU/ 새시/ 전원 팬 회전 속도계 : 샷시 (케이스) 팬 회전 속도계 - CPU/ 새시 저소음 팬 (CPU 온도에 의한 새시 팬속도 자동 조정 가능) - CPU/ 새시 팬 멀티스피드 컨트롤 - 전압 감시 기능 : +12V,+5V,+3.3V,Vcore
OS	- 마이크로 소프트 Windows® 7/7 64 비트 /Vista™/Vista™ 64 비트 / XP/XP 64 비트 와 호환 (주의 23 참조)
인증서	<ul style="list-style-type: none"> - FCC, CE, WHQL - ErP/EuP 지원 (ErP/EuP 지원 전원 공급기가 요구됨) (주의 24 참조)

* 상세한 제품정보는 당사의 웹사이트를 방문할수있습니다 . <http://www.asrock.com>

경고

오버클로킹에는 BIOS 설정을 조정하거나 Untied Overclocking Technology 를 적용하거나타업체의 오버클로킹 도구를 사용하는 것을 포함하여 어느 정도의 위험이따른다는 것을 유념하십시오 . 오버클로킹은 시스템 안정성에 영향을 주거나 심지어 시스템의 구성 요소와 장치에 손상을 입힐지도 모릅니다 . 오버클로킹은 사용자 스스로 위험과 비용을 감수하고 해야 합니다 . 당사는 오버클로킹에 의해 발생할 수 있는 손상에 대해서 책임이 없습니다 .

주의 !

1. 하이퍼 - 스테딩 기술의 셋팅에 대하여는 지원 CD 의 사용자 매뉴얼의 52 페이지를참고하세요 .
2. 이 마더보드는 듀얼 채널 메모리 기술을 지원합니다 . 듀얼 채널 메모리 기술을 구현하기 전에 올바른 설치를 위하여 17 쪽에 있는 메모리 모듈 설치 안내를읽으십시오 .
3. 운영 체제 한계 때문에 Windows® 7 / Vista™ / XP 에서 시스템 용도로 예약된 실제 메모리 크기는 4 GB 이하일 수 있습니다 . 64 비트 CPU 와 Windows® OS 의 경우 그런 한계가 없습니다 . ASRock XFast RAM 을 사용하여 Windows® 에서 사용할 수 없는 메모리를 이용할 수 있습니다 .
4. PCIE1 슬롯은 최대 3 세대 속도까지 지원합니다 . PCI Express 를 3G 속도로 실행하려면 Ivy Bridge CPU 를 설치해야 합니다 . Sandy Bridge CPU 를 설치하면 PCI Express 는 PCI Express 2G 속도로만 실행됩니다 .

5. 칩세트의 제조원이 정하였거나 그변화를 한계하게되는 최대 공유 메모리의 크기에 대하여, Intel®의 웹사이트를 방문하여 최신 정보를 받으십시오.
6. 세 대의 모니터 중에서 두 대만 사용할 수 있습니다. D-Sub, DVI-D, HDMI 모니터들을 동시에 사용할 수 없습니다. 또한 DVIHDMI 연결 어댑터를 연결하면, DVI-D 포트는 HDMI 포트와 동일한기능을 지원할 수 있습니다.
7. xvYCC 및 딥 컬러는 Windows® 7 64-bit / 7 에서만 지원됩니다. 딥 컬러모드는 디스플레이가 EDID 에서 12bpc 를 지원할 경우에만 사용됩니다. HBR 은 Windows® 7 64-bit / 7 / Vista™ 64-bit / Vista™ 에서만 지원됩니다.
8. 본 마더보드는 마이크 입력에 대해서 스테레오와 모노 모드 둘 다 지원합니다. 본 마더보드는 오디오 출력에 대해서 2 채널, 4 채널, 6 채널 및 8 채널 모드를 지원합니다. 올바른 연결을 위해 3 쪽에 나온 표를확인하십시오.
9. AXTU (ASRock Extreme Tuning Utility) 는 사용자에게 친숙한 인터페이스로 다른 시스템 기능을 미세 조정하는 일체형 도구로서, 여기에는 하드웨어 모니터, 팬 컨트롤, 오버클로킹, OC DNA, IES 등이 포함되어 있습니다. 하드웨어 모니터는 시스템의 주요 값을 표시합니다. 팬 컨트롤은 조정하려는 팬 속도와 온도를 표시합니다. 오버클로킹에서는 CPU 주파수를 오버클로킹하여 최적의 시스템 성능으로 조정할 수 있습니다. OC DNA에서는 OC 설정을 프로파일로 저장하고 이를 친구와 공유할 수 있습니다. 그러면 친구가 OS 프로파일을 자신의 시스템에 로드하여 동일한 OS 설정을 사용할 수 있습니다. IES (Intelligent Energy Saver)의 경우, 전압 조절기로 출력위상의 수를 줄여 CPU 코어가 유휴 상태일 때 컴퓨터 성능을 저하시키지 않으면서 효율을 높일 수 있습니다. ASRock의 AXTU (Extreme Tuning Utility)의 작동 절차는 당사의 웹 사이트를 참조하십시오.

ASRock 웹 사이트 : <http://www.asrock.com>

10. ASRock Instant Flash 는 플래시 ROM 에 내장된 BIOS 유틸리티입니다. 이 편리한 BIOS 업데이트 툴을 사용하면 먼저 MS-DOS 나 Windows® 같은 운영체제에 들어가지 않고도 시스템 BIOS 를 업데이트할 수 있습니다. POST 중에 BIOS 셋업 메뉴에서 <F6> 키를 누르거나 <F2> 키를 누르면이 유틸리티로 ASRock Instant Flash 에 액세스할 수 있습니다. 이제 이 툴을 시작하여 USB 플래시 드라이브, 플로피 디스크 또는 하드 드라이브에 새 BIOS 파일을 저장하면 플로피 디스켓이나 기타 복잡한 플래시 유틸리티를추가로 준비하지 않고도 몇 번의 클릭만으로도 BIOS 를 업데이트할 수 있습니다. USB 플래시 드라이브 또는 하드 드라이브는 FAT32/16/12 파일 시스템을 사용해야 합니다.
11. 아이폰 / 아이팟 터치 / 아이패드와 같은 Apple 기기들을 더 빠르고 덜제한된 방식으로 충전하려는 경우, ASRock 이 제공하는 놀라운 솔루션인 ASRock APP Charger 를 이용하십시오. APP Charger 드라이버를 설치하기만 하면 아이폰이 컴퓨터를 통해서 훨씬 더 빨리 충전되며 충전 속도도최대 40% 더 빨라집니다. ASRock APP Charger 는 많은 Apple 기기를 동시에 빨리 충전할 수 있게 하며, PC 가 대기 모드 (S1), RAM 에 대한 일시 중단 (S3), 최대 절전 모드 (S4) 또는 전원 꺼짐 모드 (S5) 에 들어갈 때도 연속적충전을 지원합니다. APP Charger 드라이버를 설치하면 그 어느 때보다 더간편하고 빠르게 충전할 수 있습니다.

ASRock 웹 사이트 : <http://www.asrock.com/Feature/AppCharger/index.asp>

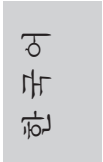

12. 인터넷 브라우저의 새로운 기능인 SmartView는 가장 많이 방문한 웹사이트, 사용자의 검색 기록, 페이스북 친구, 실시간 뉴스 피드를 더 개인적인 인터넷 경험을 위한 향상된 보기로 결합하는 IE용 스마트 시작 페이지입니다. ASRock 마더보드에만 친구들과 즉시 연락하도록 도와 주는 SmartView 유틸리티가 탑재되어 있습니다. SmartView 기능을 이용하려면 OS 버전이 Windows® 7 / 7 64 비트 / Vista™ / Vista™ 64 비트이고 브라우저 버전이 IE8 인지 확인하십시오.
ASRock 웹사이트 : <http://www.asrock.com/Feature/SmartView/index.asp>
13. ASRock XFast USB는 USB 스토리지 장치 성능을 높여줍니다. 성능은 장치의 속성에 따라 다를 수 있습니다.
14. ASRock XFast LAN은 더 빠른 인터넷 접속과 아래와 같은 이점을 제공합니다. LAN 응용 프로그램 우선순위 결정 : 응용 프로그램 우선순위를 이상적으로 구성할 수 있고 / 또는 새 프로그램을 추가할 수 있습니다. 게임 지연 시간 감소 : 온라인 게임 우선순위를 더 높게 설정한 후 게임 지연 시간을 낮출 수 있습니다. 트래픽 형성 : Youtube HD 비디오프로 보면서 동시에 파일을 다운로드할 수 있습니다. 데이터의 실시간 분석 : 상태창에서 현재 어떤 데이터 스트림을 전송 중인지 쉽게 알 수 있습니다.
15. ASRock XFast RAM은 ASRock Extreme Tuning Utility (AXTU)에 포함된 새로운 기능입니다. Windows® OS 32-bit CPU에서는 사용할 수 없는 메모리 공간을 사용합니다. ASRock XFast RAM은 이전에 방문했던 웹사이트의 로딩 시간을 단축하며 웹 서핑을 이전보다 더 빠르게 합니다. 또한 Adobe Photoshop 속도를 5배 증가 시킵니다. ASRock XFast RAM의 또 다른 장점은 SSD 또는 HDD의 액세스 빈도를 줄여 수명을 확장 늘입니다.
16. ASRock Crashless BIOS로 실패 없이 BIOS를 업데이트할 수 있습니다. BIOS 업데이트 중에 전원 공급이 끊긴 후 전원이 다시 공급되면 ASRock Crashless BIOS가 자동으로 BIOS 업데이트 과정을 완료합니다. BIOS 파일은 USB 디스크의 루트 디렉토리에 위치해야 합니다. USB2.0 포트만 이 기능을 지원합니다.
17. 관리자는 OMG를 통해 특정 시간에 인터넷을 금지하거나 인터넷 액세스를 제약할 수 있습니다. [매일], [평일] 또는 [평일 및 주말]에서 선택한 다음, 다른 사용자에게 허용된 인터넷 액세스 시작 및 종료 시간을 정할 수 있습니다. 사용자가 OMG를 무시하지 못하도록 하기 위해 시스템 시간 수정 권한이 없는 guest 계정이 필요합니다.
18. VIRTU Universal MVP에는 동종 최고의 기능을 위해 통합된 GPU 또는 독립된 GPU를 가상화하는 Virtu Universal 기술의 기본 기능이 포함되어 있습니다. 기능의 저하 없이 시각적 품질을 위해 Virtual Vsync™도 채택했습니다. HyperFormance 기술의 이점을 추가하여, VIRTU Universal MVP는 CPU, GPU 및 디스플레이 사이의 플로우에서 중복 렌더링 작업을 기능적으로 줄임으로써 게임 성능을 향상시켰습니다.
19. ASRock On/Off Play 기술은 사용자가 MP3 플레이어 또는 휴대전화와 같은 이동식 오디오 장치에서 PC에 이르는 여러 장치에서 고품질 오디오 경험을 즐길 수 있게 하며 PC가 꺼져 있을 때도 (또는 ACPI S5 모드에 있을 때도) 고품질 오디오 경험을 즐길 수 있게 합니다. 또한 이 마더보드는 사용자에게 가장 편리한 컴퓨팅 환경을 제공하는 무료의 3.5 mm 오디오 케이블 (옵션)을 제공합니다.

20. 본 마더보드는 직접 조절 기능을 제공하지만, 오버 클러킹을 하는것은 권장되지 않습니다. 권장하는 CPU 주파수 외에 다른 주파수를 설정 시에는 시스템이 불안정해지거나, 메인보드와 CPU의 불량이가 발생할 수 있으므로 가급적 사용하지 마십시오.
21. 시스템을 다시 시작하기 전에 메인보드 위의 CPU 팬이 정상적으로 동작 또는 장착되어 있는지 확인하여 주십시오. 고온 방지를 위하여 PC 시스템을 설치할 때 CPU와 방열판 사이에 그리스를 발라 주어야 합니다.
22. 콤보 클러 옵션 (C.C.O.)은 3개의 다른 CPU 클러 타입, 소켓 LGA 775, LGA 1155와 LGA 1156을 채택할 수 있는 유연한 옵션을 제공합니다. 모든 775와 1156 CPU 팬을 사용할 수 있는 것은 아닙니다.
23. ASRock XFast RAM은 Microsoft® Windows® XP / XP 64-비트 규격에서 지원되지 않습니다. Intel® Smart Connect 기술과 Intel® USB 3.0 포트은 Microsoft® Windows® Vista™/Vista™ 64비트 / XP/XP 64비트 규격에서 지원되지 않습니다.
24. EuP는 Energy Using Product (에너지 사용 제품)의 약어이며 유럽 연합이 완제품 시스템의 전력 소비량을 정의하기 위해 제정한 표준이었습니다. EuP에 따르면, 완제품 시스템의 총 AC 전원은 끄기 모드 상태에서 1.00W 미만이어야 합니다. EuP 표준을 충족하려면 EuP 지원 마더보드 및 EuP 지원 전원공급장치가 필요합니다. 인텔 (Intel)의 제안에 따르면 EuP 지원 전원공급장치는 5V 대기 전력 효율이 100 mA 전류 소비 하에서 50% 보다 높아야 한다는 기준을 충족해야 합니다. EuP 지원 전원공급장치를 선택하려면 전원공급장치 제조업체에 자세한 사항을 문의하시기 바랍니다.

1.4 온보드 헤더 및 커넥터



주의!

이 콘넥터는 접퍼가 아닙니다. 이 콘넥터 위에 접퍼 캡을 사용하지 마세요. 콘넥터에 접퍼 캡을 설치하면 마더보드가 영구적으로 손상됩니다!

시리얼 ATA2 커넥터

(SATA2_2_3:

2 페이지, 14 번 항목 참조)

(SATA2_4:

2 페이지, 21 번 항목 참조)

(SATA2_5:

2 페이지, 22 번 항목 참조)

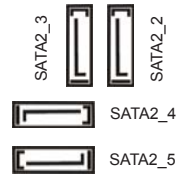

4 개의 시리얼 ATA2 (SATA)

커넥터는 내부 저장 장치용 SATA 데이터 케이블을 지원합니다. 커넥터가 내부 기억 장치용 SATA 케이블을 지원합니다. 현재의 SATA2 인터페이스는 최고 3.0 Gb/s 의 데이터 전송 속도를 지원합니다.

시리얼 ATA3 커넥터

(SATA3_A0_A1:

2 페이지, 12 번 항목 참조)

(SATA3_0_1:

2 페이지, 13 번 항목 참조)

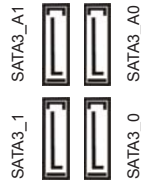

4 개의 시리얼 ATA3 (SATA3)

커넥터는 내부 저장 장치용 SATA 데이터 케이블을 지원합니다. 커넥터가 내부 기억 장치용 SATA 케이블을 지원합니다. 현재의 SATA3 인터페이스는 최고 6.0 Gb/s 의 데이터 전송 속도를 지원합니다. 후면 I/O 에 있는 eSATA3 포트가 연결된 경우, 내부 SATA3_A1 가 작동하지 않습니다.

시리얼 ATA(SATA)

데이터 케이블

(선택 사양)



SATA 데이터 케이블의 임의적인 측을 마더보드의 SATA / SATA2 / SATA3 하드 디스크 혹은 SATA2 / SATA3 커넥터에 연결합니다.

프린트 포트 헤더

(25 핀 LPT1)
(2 페이지, 28 번 항목 참조)

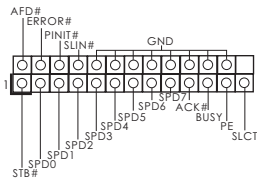

이것은 프린터 장치를 편리하게 연결할 수 있도록 해주는 프린트 포트 케이블용 인터페이스입니다.

USB 2.0 헤더

(9 핀 USB_6_7)
(2 페이지, 25 번 항목 참조)

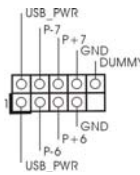

본 머더보드에는 I/O 패널에 있는 4 개의 기본 USB 2.0 포트 외에도 USB 2.0 헤더가 3 개 있습니다. 각각의 USB 2.0 헤더는 2 개의 USB 2.0 포트를 지원할 수 있습니다.

(9 핀 USB_8_9)
(2 페이지, 24 번 항목 참조)

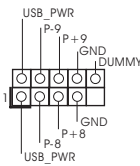

(9 핀 USB_10_11)
(2 페이지, 24 번 항목 참조)

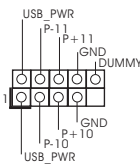

USB 3.0 헤더

(19 핀 USB3_12_13)
(2 페이지, 9 번 항목 참조)

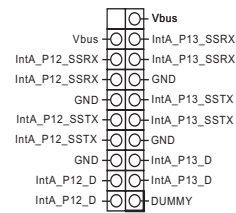

I/O 패널에 있는 2 개의 기본적인 USB 3.0 포트 이외에도 마더보드에 1 개의 USB 3.0 헤더가 있습니다. 이 USB 3.0 헤더는 2 개의 USB 3.0 포트를 지원할 수 있습니다.

적외선 모듈 헤더

(5 핀 IR1)
(2 페이지, 19 번 항목 참조)

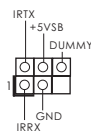

이 헤더는 선택품목인 무선 적외선 송수신 모듈을 지원합니다.

소비자용 적외선 모듈 헤더
(4핀 CIR1)
(2 페이지, 26 번 항목 참조)



이 헤더는 리모콘 수신기 연결하
는데 사용될 수 있습니다.

전면부 오디오 콘넥터
(9핀 HD_AUDIO1)
(2 페이지, 33 번 항목 참조)

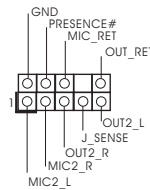

이 콘넥터는 오디오 장치를 하게
조절하고 연결할 수 있는 전면
오디오 인터페이스입니다.



1. High Definition Audio(고음질 오디오)는 잭 센스 기능을 지원하나, 제
대로 작동하려면 새시의 패널 와이어가 HAD 를 지원해야 합니다. 이 설
명서 및 새시 설명서의 지침 을 따라 시스템을 설치하십시오.
2. AC' 97 오디오 패널을 사용하는 경우, 이를 아래와 같이 프론트 패널의
오디오헤더에 설치하십시오.
 - A. Mic_IN (MIC) 을 MIC2_L 에 연결합니다.
 - B. Audio_R (RIN) 을 OUT2_R 에 연결하고, Audio_L (LIN) 을
OUT2_L 에 연결합니다.
 - C. Ground (GND) 을 Ground (GND) 에 연결합니다.
 - D. MIC_RET 및 OUT_RET 는 HD 오디오 패널 전용입니다.
이들을 AC' 97 오디오 패널에 연결 하지 않아도 됩니다.
 - E. 앞면 마이크 작동.
Windows® XP / XP 64 비트 OS 의 경우 :
"Mixer" (믹서) 와 "Recorder" (리코더) 를 선택한 후 "Front
Mic" (앞면 마이크) 를 선택합니다.
Windows® 7 / 7 64 비트 / Vista™ / Vista™ 64 비트 OS 의 경
우 :
Realtek 제어판에서 "FrontMic" (앞면 마이크) 로 가서
"Recording Volume" (리코딩 볼륨) 을 조정합니다.

시스템 콘넥터
(9핀 PANEL1)
(2 페이지, 18 번 항목 참조)

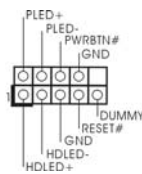

이 콘넥터는 시스템 전면 패널기
능을 지원하기 위한 것입니다.

정
사
회



새시의 전원 스위치, 리셋 스위치, 시스템 상태 표시등을 아래의 핀 할당에 따라 이헤더에 연결합니다. 케이블을 연결하기 전에 양극 핀과 음극 핀을 기록합니다.

PWRBTN(전원 스위치):

새시 전면 패널의 전원 스위치에 연결합니다. 전원 스위치를 이용해 시스템을 끄는방법을 구성할 수 있습니다.

RESET(리셋 스위치):

새시 전면 패널의 리셋 스위치에 연결합니다. 컴퓨터가 정지하고 정상작 재시작을수행하지 못할 경우 리셋 스위치를 눌러 컴퓨터를 재시작합니다.

PLED(시스템 전원 LED):

새시 전면 패널의 전원 상태 표시등에 연결합니다. 시스템이 작동하고 있을 때는 LED가 켜져 있습니다. 시스템이 S1/S3 대기 상태에 있을 때는 LED가 계속 깜박입니다. 시스템이 S4 대기 상태 또는 전원 꺼짐(S5) 상태에 있을 때는 LED가 꺼져 있습니다.

HDLED(하드 드라이브 동작 LED):

새시 전면 패널의 하드 드라이브 동작 LED에 연결합니다. 하드 드라이브가 데이터를 읽거나 쓰고 있을 때 LED가 켜져 있습니다.

전면 패널 디자인은 새시별로 다를 수 있습니다. 전면 패널 모듈은 주로 전원 스위치, 리셋 스위치, 전원 LED, 하드 드라이브 동작 LED, 스피커 등으로 구성되어 있습니다. 새시 전면 패널 모듈을 이 헤더에 연결할 때 와이어 할당과 핀 할당이 정확히 일치하는지 확인합니다.

새시 스피커 헤더

(4 핀 SPEAKER 1)
(2 페이지, 16 번 항목 참조)

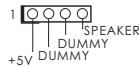

새시 스피커를 이 헤더에 연결하십시오.

전원 LED 헤더

(3 핀 PLED1)
(2 페이지, 17 번 항목 참조)



시스템 전원 상태를 표시하려면 새시 전원 LED를 헤더에 연결하십시오. 시스템 작동 중에는 LED에 전원이 켜져 있습니다. S1/S3 상태에서는 LED가 계속 깜박입니다. S3/S4 상태 또는 S5 상태에서는 LED가 꺼집니다 (전원 꺼짐).

새시 / 전원 팬 커넥터
(4 핀 CHA_FAN1)
(2 페이지, 22 번 항목 참조)

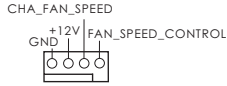

팬 케이블을 팬 커넥터에 연결하고 접지 핀에는 검은색 전선을 연결하십시오. CHA_FAN1, 및 CHA_FAN2 은 팬 제어를 지원합니다.

(3 핀 CHA_FAN2)
(2 페이지, 35 번 항목 참조)

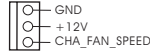

(3 핀 PWR_FAN1)
(2 페이지, 2 번 항목 참조)

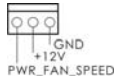

CPU 팬 커넥터
(4 핀 CPU_FAN1)
(2 페이지, 3 번 항목 참조)

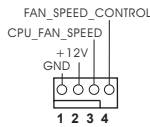

CPU 팬 케이블을 이 커넥터에 연결하고 흑색 선을 접지 핀에 맞추십시오.



본 마더보드가 4 핀 CPU 팬 (저소음 팬) 지원을 제공하지는 않지만 팬 속도 제어기능없이도 3 핀 CPU 팬을 성공적으로 작동할 수 있습니다. 본 마더보드의 CPU 팬 커넥터에 3 핀 CPU 팬을 연결하려면 1-3 번 핀에 연결하십시오.

1-3 번 핀에 연결됨 ←

3 핀 팬 설치



(3 핀 CPU_FAN2)
(2 페이지, 1 번 항목 참조)

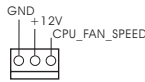

ATX 전원 헤더
(24 핀 ATXPWR1)
(2 페이지, 8 번 항목 참조)

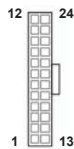

ATX 전원 공급기를 이 헤더에 연결하십시오.



이 마더보드는 24 핀 ATX 전원 커넥터를 제공하지만, 종래의 20 핀 ATX 전원 공급장치를 사용해도 작동이 가능합니다. 20 핀 ATX 전원 공급장치를 사용하려면, Pin 1 과 Pin 13 으로 전원공급장치를 연결하십시오.

20 핀 ATX 전원 공급장치 설치

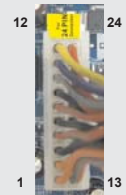

중
간
중

ATX 12V 파워 콘넥터
(8 핀 ATX12V1)
(2 페이지, 4 번 항목 참조)



ATX 12V 플러그가 달린 전원 공급장치를 이 커넥터에 연결해야 충분한 전력을 공급할 수 있습니다. 그러지 않을 경우 전원을 켤 수 없습니다.



비록 본 마더보드는 8- 핀 ATX 12V 전원 연결기를 제공하지만 이것은 여전히 작업할 수 있습니다. 만약 전통적인 4- 핀 ATX 12V 전원공급을 채용하여 4- 핀 ATX 전력을 사용하는 경우, 반드시 전원 공급을 핀 1 과 핀 5 에 전원공급을 삽입해야 합니다.

4- 핀 ATX 12V 전원공급장치



시리얼포트 콘넥터
(9 핀 COM1)
(2 페이지, 27 번 항목 참조)

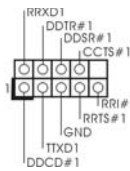

이 콘넥터는 시리얼 포트 모듈을 지원합니다.

HDMI_SPDIF 헤더
(2 핀 HDMI_SPDIF1)
(2 페이지, 34 번 항목 참조)



HDMI VGA 카드에 SPDIF 오디오 출력을 제공하는 HDMI_SPDIF 헤더는 시스템이 HDMI 디지털 TV/ 프로젝터 / LCD 장치에 연결할 수 있게 합니다. HDMI VGA 카드의 HDMI_SPDIF 커넥터를 이 헤더에 연결하십시오.

2. 시스템 바이오스 정보

메인보드의 플래쉬 메모리에는 바이오스 셋업 유틸리티가 저장되어 있습니다. 컴퓨터를 사용하실 때, “자가진단 테스트” (POST) 가 실시되는 동안 <F2> 또는 키를 눌러 바이오스 셋업으로 들어가세요; 만일 그렇게 하지 않으면 POST 는 테스트 루틴을 계속하여 실행할 것입니다. 만일 POST 이후 바이오스 셋업을 하기 원하신다면, <Ctl>+<Alt>+<Delete> 키를 누르거나, 또는 시스템 본체의 리셋 버튼을 눌러 시스템을 재 시작하여 주시기 바랍니다. 바이오스 셋업 프로그램은 사용하기 편하도록 디자인되어 있습니다. 각 항목은 다양한 서브 메뉴 표가 올라오며 미리 정해진 값 중에서 선택할 수 있도록 되어 있습니다. 바이오스 셋업에 대한 보다 상세한 정보를 원하신다면 보조 CD 안의 포함된 사용자 매뉴얼 (PDF 파일) 을 따라 주시기 바랍니다.

3. 소프트웨어 지원 CD 정보

이 메인보드는 여러 가지 마이크로소프트 윈도우 운영 체계를 지원합니다:
7/7 64 비트 /Vista™/Vista™ 64 비트 /XP/XP 64 비트. 메인보드에 필요한 드라이버와 사용자 편의를 위해 제공되는 보조 CD 는 메인보드의 기능을 향상시켜 줄 것입니다. 보조 CD 를 사용하여 시작하시려면, CD-ROM 드라이브에 CD 를 넣어주시기 바랍니다. 만일 고객님의 컴퓨터가 “AUTORUN” 이 가능하다면 자동으로 메인 메뉴를 모니터에 디스플레이 시켜 줄 것입니다. 만일 자동으로 메인 메뉴가 나타나지 않는다면, 보조 CD 의 디스플레이 메뉴 안에 있는 BIN 폴더 ASSETUP.EXE 파일을 더블 클릭하여 주시기 바랍니다.

(D: \BIN\ASSETUP.EXE, D: 는 CD-ROM 드라이브)

1. はじめに

ASRock **Z77 Pro4-M** マザーボードをお買い上げいただきありがとうございます。本製品は、弊社の厳しい品質管理の下で製作されたマザーボードです。本製品は、弊社の品質と耐久性の両立という目標に適合した堅牢な設計により優れた性能を実現します。このクイックインストールガイドには、マザーボードの説明および段階的に説明したインストールの手引きが含まれています。マザーボードに関するさらに詳しい情報は、「サポートCD」のユーザーマニュアルを参照してください。



マザーボードの仕様および BIOS ソフトウェアは、アップデートされることがありますので、マニュアルの内容は、予告なしに変更されることがあります。本マニュアルに変更があった場合は、弊社のウェブサイトに予告なしに最新版のマニュアルが掲載されます。最新の VGA カードおよび CPU サポートリストもウェブサイトでご覧になれます。ASRock 社ウェブサイト:<http://www.asrock.com>
このマザーボードに関連する技術サポートが必要な場合、当社の Web サイトにアクセスし、使用しているモデルについての特定情報を見つけてください。
www.asrock.com/support/index.asp

1.1 パッケージ内容

ASRock **Z77 Pro4-M** マザーボード:

(Micro ATX フォームファクター: 9.6-in x 9.6-in, 24.4 cm x 24.4 cm)

ASRock **Z77 Pro4-M** クイックインストールガイド

ASRock **Z77 Pro4-M** サポート CD

2 x シリアル ATA (SATA) データケーブル(オプション)

1 x I/O パネルシールド



ASRockからのお知らせ...

Windows® 7 / 7 64-bit / Vista™ / Vista™ 64-bit でより良い性能を得るには、ストレージ構成のBIOSオプションをAHCIモードに設定することを推奨します。BIOSのセットアップについての詳細は、サポートCDの「ユーザーマニュアル」を参照してください。

1.2 仕様

プラットフォーム	<ul style="list-style-type: none"> - Micro ATX フォームファクター： 9.6-in x 9.6-in, 24.4 cm x 24.4 cm - 全ソリッド・キャパシタ設計 (日本製高品質 100% 導電性高分子コンデンサ)
CPU	<ul style="list-style-type: none"> - LGA1155 パッケージで、第三世代および第二世代 Intel® Core™ i7 / i5 / i3 をサポートします - デジタル電源設計 - 4 + 2 電源位相設計 - Intel® Turbo 2.0 ブーストテクノロジーをサポート - K シリーズのアンロック CPU - ハイパースレッドテクノロジーをサポート (注意 1 を参照) - Intel® Ivy Bridge CPU で Intel® Rapid Start テクノロジーおよび Smart Connect テクノロジーをサポートします
チップセット	<ul style="list-style-type: none"> - Intel® Z77
メモリー	<ul style="list-style-type: none"> - デュアルチャネル DDR3 メモリ技術 (注意 2 を参照) - DDR3 DIMM スロット x 4 - DDR3 2800+(OC)/2400(OC)/2133(OC)/1866(OC)/1600/1333/1066 non-ECC, un-buffered メモリーに対応 - システムメモリの最大容量: 32GB (注意 3 を参照) - Intel® Extreme Memory Profile (XMP)1.3/1.2 をサポート
拡張スロット	<ul style="list-style-type: none"> - 1 x PCI Express 3.0 x16 スロット (PCIe1 : x16 モード) (注意 4 を参照) * PCIe 3.0 は、Intel® Ivy Bridge CPU でのみサポートされます。Intel® Sandy Bridge CPU では、PCIe 2.0 のみをサポートします。 - 2 x PCI Express 2.0 x16 スロット (PCIe3 : x1 モード、PCIe4 : x4 モード) - 1 x PCI Express 2.0 x1 スロット - AMD Quad CrossFireX™ および CrossFireX™ をサポート
グラフィック	<ul style="list-style-type: none"> * Intel® HD Graphics Built-in Visuals および VGA 出力に対応するのは、GPU が内蔵されているプロセッサを使用する場合だけです。 - Intel® HD グラフィックス内蔵ビジュアルのサポート: Intel® Quick Sync Video 2.0、Intel® InTru™ 3D、Intel® Clear Video HD Technology、Intel® Insider™、Intel® HD Graphics 2500/4000 - Intel® Ivy Bridge CPU を搭載した DirectX 11、Pixel Shader 5.0、Intel® Sandy Bridge CPU を搭載した DirectX 10.1、Pixel Shader 4.1。

	<ul style="list-style-type: none"> - 最大の共有メモリ1760MB (注意5を参照) - 3つのVGA出力オプション:D-Sub、DVI-D、HDMI (注意6を参照) - 1920x1200 @ 60Hzの最大解像度でHDMI 1.4aをサポート - 1920x1200 @ 60Hzの最大解像度でDVIをサポート - 2048x1536 @ 75Hzの最大解像度でD-Subをサポート - オート・リップシンク、ディープカラー(12bpc)、xvYCC、HBR(High Bit Rate)オーディオ、HDMI (HDMI準拠モニタが必要)をサポート (注意7を参照) - HDCP機能、DVI、HDMIポートをサポート - 1080p Blu-ray (BD) / HD-DVD再生サポート、DVI、HDMIポートをサポート
オーディオ	<ul style="list-style-type: none"> - 7.1 CH HD オーディオ (コンテンツ保護付) (Realtek ALC892 オーディオ Codec) - Premium Blu-ray オーディオのサポート - THX TruStudio™ をサポート
LAN	<ul style="list-style-type: none"> - PCIE x1 Gigabit LAN 10/100/1000 Mb/s - Realtek RTL8111E - Wake-On-LANをサポート - LANケーブル検出をサポート - Energy Efficient Ethernet 802.3azをサポート - PXEをサポート
リアパネル I/O	<p>I/O Panel</p> <ul style="list-style-type: none"> - PS/2 キーボードポート x 1 - D-Sub ポート x 1 - DVI-D ポート x 1 - HDMI ポート x 1 - 光学 SPDIF 出力ポート x 1 - Ready-to-Use USB 2.0 ポート x 4 - eSATA3 コネクタ x 1 - Ready-to-Use USB 3.0 ポート x 2 - LED(ACT/LINK LED および SPEED LED)付き RJ-45 LAN ポート x 1 - オーディオジャック: 後部スピーカー、中央、低音、入力、前部スピーカー、マイク入力 (注意8参照)
SATA3	<ul style="list-style-type: none"> - Intel® Z77 SATA3 6.0Gb/秒 コネクタ x 2 ハードウェア RAID (RAID 0, RAID 1, RAID 5, RAID 10, Intel Rapid Storage および Intel Smart Response 技術) をサポート, NCQ, AHCI および Hot Plug (ホットプラグ) 機能 - ASMedia ASM1061 SATA3 6.0Gb/秒 コネクタ x 2 ハードウェアをサポート, NCQ, AHCI および Hot Plug (ホットプラグ) 機能 (SATA3_A1 コネクタは eSATA3 ポートと共有)

USB 3.0	<ul style="list-style-type: none"> - 2 x リア USB 3.0 ポート、USB 1.0/2.0/3.0 に最高 5Gb/s まで対応 - 1 x フロント USB 3.0 ヘッダ (USB 3.0 ポート 2 基対応)、USB 1.0/2.0/3.0 に最高 5Gb/s まで対応
コネクタ	<ul style="list-style-type: none"> - 4 x SATA2 3.0Gb/秒コネクタが、RAID (RAID 0, RAID 1, RAID 5, RAID 10, Intel Rapid Storage および Intel Smart Response 技術) をサポート, NCQ, AHCI および Hot Plug (ホットプラグ) 機能 - 4 x SATA3 6.0Gb/秒コネクタが - IR ヘッダー x 1 - コンシューマー赤外線モジュールヘッダー x 1 - プリントポートヘッダ x 1 - COM ポートヘッダ x 1 - HDMI_SPDIF ヘッダー x 1 - 電源 LED ヘッダー x 1 - CPU/シャーシ / 電源ファンコネクタ - 24ピン ATX 電源コネクタ - 8ピン 12V 電源コネクタ - フロントパネルオーディオコネクタ - USB 2.0 ヘッダー (USB 2.0 用 6 ポートをサポート) x 3 - USB 3.0 ヘッダー (USB 3.0 用 2 ポートをサポート) x 1
BIOS 関連機能	<ul style="list-style-type: none"> - 64Mb AMI UEFI Legal BIOS (GUI サポート) - プラグ&プレイをサポート - ACPI 1.1 準拠ウェイクアップイベント - jumperfree モードサポート - SMBIOS 2.3.1 サポート - CPU Core, iGPU, DRAM, 1.8V PLL, VTT, VCCSA 電圧のマルチ調整
サポート CD	<ul style="list-style-type: none"> - ドライバ、ユーティリティ、AntiVirusソフトウェア (試用バージョン)、CyberLink MediaEspresso 6.5 試用版、ASRock MAGIX Multimedia Suite - OEM
特徴	<ul style="list-style-type: none"> - ASRock Extreme チューニングユーティリティ (AXTU) (注意 9 参照) - ASRock インスタントブート - ASRock Instant Flash (注意 10 参照) - ASRock APP エャージャー (注意 11 を参照) - ASRock SmartView (注意 12 を参照) - ASRock XFast USB (注意 13 を参照) - ASRock XFast LAN (注意 14 を参照) - ASRock XFast RAM (注意 15 を参照) - ASRock Crashless BIOS (注意 16 を参照) - ASRock OMG (Online Management Guard)

	<p>(注意 17 を参照)</p> <ul style="list-style-type: none"> - Lucid Virtu Universal MVP (注意 18 を参照) * Lucid Virtu Universal MVP に対応するのは、GPU が内蔵されているプロセッサを使用する場合だけです。 - ASRock オン / オフ再生技術 (注意 19 を参照) - ハイブリッドブースタ <ul style="list-style-type: none"> - CPU 周波数無段階制御 (注意 20 を参照) - ASRock U-COP (注意 21 を参照) - 起動障害保護 (Boot Failure Guard:B.F.G.) - コンボクーラーオプション (C.C.O.) (注意 22 を参照) - グッドナイト LED
モニター	<ul style="list-style-type: none"> - CPU 温度検知 - マザーボード温度検知 - CPU / シャーシ / 電源ファンタコメータ - CPU / シャーシ静音ファン (CPU 温度によりシャーシファン速度の自動調整が可能) - CPU / シャーシファンマルチ速度制御 - 電源モニター: +12V, +5V, +3.3V, Vcore
OS	<ul style="list-style-type: none"> - Microsoft® Windows® 7 / 7 64-bit / Vista™ / Vista™ 64-bit / XP / XP 64-bit compliant (注意 23 を参照)
認証	<ul style="list-style-type: none"> - FCC, CE, Microsoft® WHQL 認証済み - ErP/EuP 対応 (ErP/EuP 対応の電源装置が必要です) (注意 24 を参照)

* 製品の詳細については、<http://www.asrock.com> を御覧ください。

警告

オーバークロック (BIOS 設定の調整、アンタイド・オーバークロック・テクノロジーの適用、第三者のオーバークロックツールの使用など) はリスクを伴いますのでご注意ください。オーバークロックするとシステムが不安定になったり、システムのコポーネントやデバイスが破損することがあります。ご自分の責任で行ってください。弊社では、オーバークロックによる破損の責任は負いかねますのでご了承ください。

注意

1. “ハイバースレッドテクノロジ”の設定については、サポート CD の「ユーザーマニュアル」の 52 ページをエックしてください。
2. このマザーボードは、デュアルチャンネルメモリーテクノロジー (Dual Channel Memory Technology) をサポートしております。デュアルチャンネルメモリーテクノロジーを実行する前に、正しいインストール法を理解する為に 17 ページのメモリーモジュールのインストールガイドをお読みください。
3. オペレーティングシステム制限のため、Windows® 7 / Vista™ / XP 使用下において、システム使用のリザーブに対する実際の記憶容量は 4GB 未

- 満である可能性があります。64ビットCPUのWindows® OSに対しては、そのような制限はありません。ASRock XFast RAM を使って Windows® が使用できないメモリを利用することができます。
4. PCIE1 スロットは Gen 3 までの速度に対応します。Gen3 速度で PCI Express を実行するには、Ivy Bridge CPU を取り付ける必要があります。Sandy Bridge CPU を取り付けると、PCI Express は PCI Express Gen 2 の速度でのみ作動します。
 5. 最大共有メモリサイズは、チップセットメーカーによって定義され、それぞれ異なります。Intel® 社の WEB サイトで最新情報を確認してください。
 6. 3 台のモニタのうち使用できるのは 2 台だけです。D-Sub、DVI-D および HDMI モニタを同時に使用することはできません。なお、DVI - HDMI 変換アダプタを使えば、DVI-D ポートは HDMI ポートと同じ機能をサポートできます。
 7. xvYCC とディープカラーは Windows® 7 64-bit / 7 上でのみ使用できます。ディープカラーを使用できるのは、ディスプレイが EDID で 12bpc をサポートしている場合だけです。HBR は Windows® 7 64-bit / 7 / Vista™ 64-bit / Vista™ で使用できます。
 8. マイク入力の場合、このマザーボードはステレオとモノラルモードをどちらもサポートします。オーディオ出力の場合、このマザーボードは 2 チャンネル、4 チャンネル、6 チャンネルと 8 チャンネルモードをサポートします。正しい接続については、3 ページの表をチェックしてください。
 9. ASRock Extreme Tuning Utility (AXTU) は、分かりやすいインターフェイスでさまざまなシステム機能を微調整するオールインワンツールで、ハードウェアモニタ、ファンコントロール、オーバークロック、OC DNA、ES などを含んでいます。ハードウェアモニタでは、システムの主要な読み込みを示します。ファンコントロールでは、調整するファン速度と温度を示します。オーバークロックでは、CPU 周波数をオーバークロックして最適のシステムパフォーマンスを出すことができます。OC DNA では、プロファイルとして OC 設定を保存し友人と共有することができます。友人は OC プロファイルを自分のシステムに読み込んで、同じ OC 設定にすることが可能です。IES (インテリジェントエネルギーサーバー) では、電圧レギュレータにより、CPU コアがアイドルになっているときコンピュータの性能を犠牲にすることなく、多くの出力位相を削減して効率性の向上を図ります。ASRock Extreme Tuning Utility (AXTU) の操作手順については、当社 Web サイトをご覧ください。
ASRock Web サイト:<http://www.asrock.com>
 10. ASRock Instant Flash は、Flash ROM(フラッシュ ROM)に組み込まれている BIOS フラッシュユーティリティです。この便利な BIOS 更新ツールにより、MS-DOS あるいは Windows® のように最初にオペレーティングシステムに入る必要なしに、システム BIOS を更新することができます。このユーティリティでは、POST の間に〈F6〉キーを、あるいは BIOS 設置アップメニューの際に〈F2〉キーを押すことで、ASRock Instant Flash にアクセスすることができます。このツールを起動し、新規 BIOS ファイルを USB フラッシュドライブ、フロッピーディスク、またはハードドライブに保存、そしていくつかのクリックだけで、その他のフロッピーディスクや複雑なフラッシュユーティリティを使用せずに BIOS を更新することができます。ご使用の際には、USB フラッシュドライブあるいはハードドライブが FAT32/16/12 ファイルシステムを使用していることを確認してください。

11. iPhone/iPad/iPod Touch など Apple デバイスを迅速かつお手軽に充電するために、ASRock では ASRock APP チャージャーという素晴らしいソリューションをご用意しています。APP チャージャードライバをインストールするだけで、ご使用の iPhone をコンピュータから素早く充電することができます。充電時間は従来より最高 40% も速くなります。ASRock APP チャージャーをお使いいただくと複数の Apple デバイスを同時に素早く充電できます。本製品は PC がスタンバイモード (S1)、メモリスuspendモード (S3)、休止モード (S4) または電源オフ (S5) の時にも継続充電をサポートします。APP チャージャードライバをインストールしていただくと、これまでにない充電性能に充分ご満足いただけることでしょう。
ASRock の Web サイト：
<http://www.asrock.com/Feature/AppCharger/index.asp>
12. インターネットブラウザの新しい SmartView 機能は、よくアクセスするウェブサイト、閲覧履歴、Facebook の友達およびあなたのリアルタイムのニュースフィードを、よりパーソナルなインターネット体験のために改良されたビューに一体化させた、IE 用の賢いスタートページです。ASRock マザーボードは独占的に SmartView ユーティリティを備えており、あちこち移動する友達と連絡を取り合うのに役立ちます。SmartView 機能を使用するには、お使いの OS のバージョンが Windows® 7 / 7 64 bit / Vista™ / Vista™ 64 bit であり、ブラウザのバージョンが IE8 であることをご確認ください。
ASRock ウェブサイト：<http://www.asrock.com/Feature/SmartView/index.asp>
13. ASRock XFast USB は USB ストレージデバイス性能を拡張することができます。デバイスの特長により性能は異なります。
14. ASRock XFast LAN は以下のメリットを含め、高速インターネットアクセスを提供します。LAN アプリケーション優先順位:アプリケーションの理想的な優先順位を設定し、新しいプログラムを追加することができます。ゲームの低いレイテンシ:オンラインゲームの優先順位を高く設定した後に、ゲームのレイテンシを下げるすることができます。トラフィックの成形:Youtube HD ビデオを視聴しながらファイルをダウンロードできます。データのリアルタイムの分析:ステータスウィンドウがあれば、現在転送しているデータストリームを容易に認識できます。
15. ASRock XFast RAM は、AXTU(ASRock Extreme Tuning Utility)を含む新機能です。Windows® オペレーティングシステム 32 ビット CPU の下では使用できないメモリ空間を利用します。ASRock XFast RAM は、以前に訪れたウェブサイトの表示にかかる時間を短縮し、これまで以上に迅速にネットサーフィンを行えるようにします。また、Adobe Photoshop の処理速度を 5 倍に押し上げます。ASRock XFast RAM の他の利点は、お使いの SSD または HDD へのアクセスを減らして、それらの寿命を延ばすことです。
16. ASRock Crashless BIOS を使って、ユーザーは失敗のおそれなく BIOS を更新することができます。BIOS 更新プロセス中に電源損失が発生した場合、ASRock Crashless BIOS は電源回復後、自動的に BIOS 更新プロセスを完了させます。BIOS ファイルを USB ディスクのルートディレクトリに配置する必要があることに注意してください。USB 2.0 ポートのみがこの機能をサポートします。

17. 管理者はインターネットカーヒューを確立したり、OMG 経由で指定された時間にインターネットへのアクセスを制限したりできます。[毎日]、[曜日]または [終日と終末] から選択してから、他のユーザーに与えられたインターネットアクセスの開始時間と終了時間をスケジュールに入れることができます。ユーザーが OMG を回避できないように、システム時間を変更する許可のないゲストアカウントが必要です。
18. VIRTU Universal MVP は、Virtu Universal テクノロジーの基本機能を含んでおり、統合 GPU および離散 GPU を最高機能に仮想化します。また、妥協を許さない表示品質を実現するため Virtual Vsync™ を備えています。追加された HyperFormance 技術の利点により、VIRTU Universal MVP は、CPU 間および GPU とディスプレイ間の冗長的なレンダリングタスクを効果的に減らすことによりゲーム性能を改善します。
19. ASRock オン / オフ技術により、ユーザーは PC の電源がオフになっている場合でも(または ACPI S5 モードで)、MP3 プレーヤーや携帯電話などのポータブルオーディオデバイスから PC に転送された素晴らしいオーディオ体験をお楽しみいただけます。このマザーボードは無料の 3.5mm オーディオケーブル (オプション)も付属しているため、もっとも便利なコンピューティング環境を利用することもできます。
20. このマザーボードは、無段階制御を提供しますが、オーバークロックの実行はお薦めしません。推奨 CPU バス周波数以外の周波数は、システムを不安定にしたり CPU を損傷したりすることがあります。
21. CPU のオーバーヒートが検出されると、システムは自動的にシャットダウンされます。システムのレゾームを行う前に、マザーボード上の CPU 冷却ファンが正しく機能しているか確認してから電源コードを外し、そして再度つないでください。放熱効果を高める為には、PC システムのインストール時に、CPU とヒートシンクの間放熱グリスをスプレーするのが効果的です。
22. コンボクーラーオプション (C.C.O.) では、Socket LGA 775、LGA 1155 と LGA 1156 の 3 つの異なる CPU クーラータイプを採用できる、柔軟なオプションを用意しています。すべての 775 と 1156 CPU ファンを使用できるわけではないことにご注意ください。
23. ASRock XFast RAM は、Microsoft® Windows® XP / XP 64 ビット準拠によりサポートされません。Intel® Smart Connect テクノロジーおよび Intel® USB 3.0 ポートは、Microsoft® Windows® Vista™ / Vista™ 64-bit / XP / XP 64-bit ビット準拠によりサポートされません。
24. Energy Using Product (エコデザイン) の略語 EuP は完成システムの消費電力を定義するために欧州連合により規制された条項です。EuP に従って、管制システムの総 AC 電力はオフモード条件下で 1.00W 未満に抑える必要があります。EuP 規格を満たすには、EuP 対応マザーボードと EuP 対応電源が必要です。Intel の提案に従い、EuP 対応電源装置は規格を満たす必要があります、つまり 5v のスタンバイ電力効率は 100 mA の消費電流下で 50% 以上でなければなりません。EuP 対応電源装置を選択する場合、電源装置製造元に詳細を確認するようにお勧めします。

1.3 ジャンパ設定

右の図はジャンパがどのように設定されているかを示します。ジャンパキャップがピンに置かれている場合、ジャンパは“ショート”になります。ジャンパキャップがピンに置かれていない場合、ジャンパは“オープン”になります。右の図で、3ピンジャンパで、1-2ピンを“ショート”の場合、これらの2つのピンにジャンパキャップを置きます。

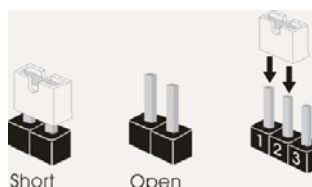

ジャンパ	設定	説明
CMOS の消去ジャンパ (CLR CMOS1) (ページ2 アイテム 15 参照)	<p>1_2</p> <p>デフォルト設定</p>	<p>2_3</p> <p>CMOS の消去</p>

注： CLR CMOS1 により、CMOS のデータをクリアできます。システムパラメータをクリアしデフォルト設定にリセットするには、コンピュータの電源をオフにし、電源装置から電源コードを抜いてください。15 秒待ってから、ジャンパキャップを使用して CLR CMOS1 のピン 2 とピン 3 を 5 秒間ショートしてください。ただし、BIOS 更新の後すぐには CMOS をクリアしないでください。BIOS の更新の終了後直ちに CMOS をクリアする必要がある場合、まずシステムを起動してからシャットダウンし、その後クリア CMOS アクションを実行する必要があります。パスワード、日付、時刻、ユーザーデフォルトのプロファイルを忘れずにメモしてください。1394 GUID と MAC アドレスは、CMOS バッテリを取り外した場合のみ消去されます。

1.4 オンボードのヘッダとコネクタ類



オンボードのヘッダとコネクタ類はジャンパではありません。それらのヘッダやコネクタにジャンパキャップをかぶせないでください。ヘッダやコネクタにジャンパキャップをかぶせると、マザーボードに深刻な影響を与える場合があります。

シリアル ATA2 コネクタ

SATA2_2,3: ページ 2,
アイテム 14 を参照
SATA2_4: ページ 2,
アイテム 21 を参照
SATA2_5: ページ 2,
アイテム 20 を参照

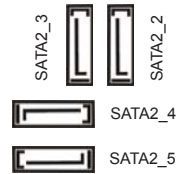

これら 4 本のシリアル ATA2 (SATA2) コネクタは内蔵ストレージデバイスに使用する SATA データケーブルに対応しています。現在の SATA2 インタフェースの最大データ転送速度は 3.0Gb/s です。

シリアル ATA3 コネクタ

SATA3_A0_A1: ページ 2,
アイテム 12 を参照
SATA3_0_1: ページ 2,
アイテム 13 を参照

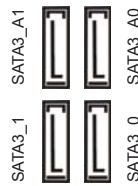

これら 4 本のシリアル ATA3 (SATA3) コネクタは内蔵ストレージデバイスに使用する SATA データケーブルに対応しています。現在の SATA3 インタフェースの最大データ転送速度は 6.0Gb/s です。背面入出力上の eSATA3 ポートが接続されている場合、内部 SATA3_A1 は機能しません。

シリアル ATA(SATA) データケーブル(オプション)



SATA データケーブルのどちらかの端をマザーボードの SATA / SATA2 / SATA3 ハードディスク、または SATA2 / SATA3 コネクタに接続できます。

プリントポートヘッダ

(25ピン LPT1)
ページ 2, アイテム 28 を参照

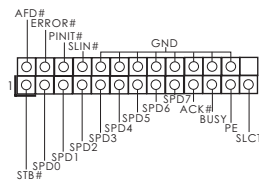

これはプリントポートケーブル用のインターフェイスで、プリンタデバイスの接続を可能にします。

USB 2.0 ヘッダ

(9ピン USB_6_7)

ページ2, アイテム 25 を参照

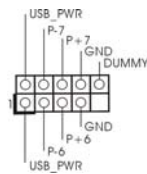

I/O パネルには、デフォルトの 4 つの USB 2.0 ポート以外に、このマザーボードに 3 つの USB 2.0 ヘッダが搭載されています。それぞれの USB 2.0 ヘッダは 2 つの USB 2.0 ポートをサポートできます。

(9ピン USB_8_9)

ページ2, アイテム 24 を参照

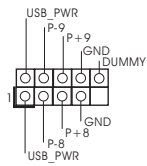

(9ピン USB_10_11)

ページ2, アイテム 23 を参照

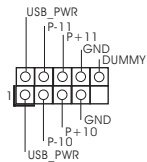

USB 3.0 ヘッダ

(19ピン USB3_12_13)

ページ2, アイテム 9 を参照

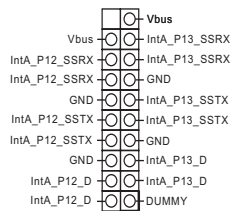

I/O パネルには、デフォルトの 2 つの USB 3.0 ポート以外に、このマザーボードに 1 つの USB 3.0 ヘッダが搭載されています。それぞれの USB 3.0 ヘッダは 2 つの USB 3.0 ポートをサポートできます。

赤外線モジュールコネクタ

(5ピン IR1)

ページ2, アイテム 19 を参照

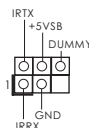

このコネクタは赤外線無線受信モジュールに対応します。

コンシューマー赤外線モジュールヘッダー

(4ピン CIR1)

ページ2, アイテム 26 を参照



このヘッダーは、リモコン受光部の接続に使用することができます。

フロントオーディオパネルコネクタ
(9ピン HD_AUDI01)
ページ2, アイテム 33 を参照

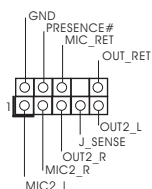

このコネクタは、オーディオ機器との便利な接続とコントロールを可能にするフロントオーディオパネルのためのインターフェイスです。



1. ハイディフィニションオーディオはジャックセンシングをサポートしますが、正しく機能するためにシャーシのパネルワイヤが HDA をサポートする必要があります。このマニュアルとシャーシのマニュアルの指示に従って、システムを取り付けてください。
2. AC'97 オーディオパネルを使用する場合、次のように前面パネルのオーディオヘッダに取り付けてください。
 - A. Mic_IN (MIC) を MIC2_L に接続します。
 - B. Audio_R (RIN) を OUT2_R に、Audio_L (LIN) を OUT2_L に接続します。
 - C. Ground (GND) を Ground (GND) に接続します。
 - D. MIC_RET と OUT_RET はオーディオパネル専用です。AC'97 オーディオパネルに接続する必要はありません。
 - E. フロントマイクを有効化するには。
Windows® XP / XP 64-bit OS の場合：
“Mixer” (ミキサー) を選択し、続いて “Recorder” (レコーダー) を選択します。その後 “FrontMic” (フロントマイク) をクリックします。
Windows® 7 / 7 64-bit / Vista™ / Vista™ 64-bit OS の場合：
Realtek コントロールパネルから “FrontMic” (フロントマイク) タブを開きます。“Recording Volume” (録音音量) を調整します。

システムパネルコネクタ
(9ピン PANEL1)
ページ2, アイテム 18 を参照

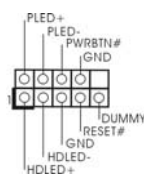

このコネクタは数種類のシステムフロントパネルの機能を提供します。



シャーシに付いている電源スイッチ、リセットスイッチ、システムステータスインジケータを下記のピン割り当て指示に従ってこのヘッダに接続します。ケーブルを接続する前にピンの正負極性にご確認ください。

PWRBTN (電源スイッチ):

前面パネルに付いている電源スイッチに接続します。電源スイッチによるシステム電源オフ方法を設定して変更することも可能です。

RESET (リセットスイッチ):

シャーシの前面パネルに付いているリセットスイッチに接続します。コンピュータがフリーズし、正常な再起動をしない場合は、リセットスイッチを押してコンピュータを再起動します。

PLED (システム電源 LED):

シャーシの前面パネルに付いている電源ステータスインジケータに接続します。LED は、システムが動作しているときに点灯します。LED はシステムが S1/S3 スリープ状態のときに点滅します。システムが S4 スリープ状態になるか、電源オフ (S5) になると、LED は消灯します。

HDLED (ハードドライブアクティビティ LED):

シャーシの前面パネルに付いているハードドライブアクティビティ LED に接続します。LED は、ハードドライブがデータの読み込みまたは書き込み動作をしているときに点灯します。

前面パネルのデザインはシャーシによって異なります。前面パネルモジュールは、主に電源スイッチ、リセットスイッチ、電源 LED、ハードドライブアクティビティ LED、スピーカーなどから構成されています。シャーシの前面パネルモジュールをこのヘッダに接続する際は、ワイヤとピンの割り当てが正しく対応していることを確認してください。

シャーシスピーカーヘッダ
(4ピン SPEAKER1)
ページ2, アイテム 16 を参照

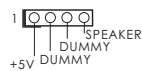

シャーシのスピーカーとこのヘッダを接続してください。

電源 LED ヘッダー
(3ピン PLED1)
ページ2, アイテム 17 を参照



シャーシ電源 LED をこのヘッダーに接続し、システム電源ステータスを示すようにしてください。LED はシステムが動作中の際にオンになります。S1 ステータスでは LED は点滅し続けます。S3/S4 ステータス、または S5 ステータス (電源オフ) の場合、LED は消灯します。

シャーシおよび電源ファンコネクタ

(4ピン CHA_FAN1)

ページ2, アイテム 22 を参照

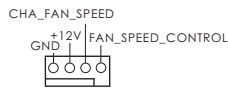

(3ピン CHA_FAN2)

ページ2, アイテム 35 を参照

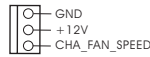

(3ピン PWR_FAN1)

ページ2, アイテム 2 を参照

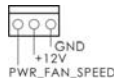

ファンケーブルをファンコネクタに接続し、黒いワイヤをアースピンに合わせてください。CHA_FAN1 および CHA_FAN2 は、ファンコントロールをサポートします。

CPU ファンコネクタ

(4ピン CPU_FAN1)

ページ2, アイテム 3 を参照

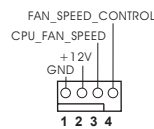

このコネクタには CPU ファケーブルを接続します。黒いコードはアースピンに接続してください。



このマザーボードでは4ピンCPUファン(クワイエットファン)がサポートされていますが、ファン速度コントロール機能がない場合でも、3ピンCPUファンは正常に作動します。3ピンCPUファンをこのマザーボードのCPUファンコネクタに接続しようとしている場合、ピン1-3に接続してください。

接続されたピン1-3
3ピンファンのインストール



(3ピン CPU_FAN2)

ページ2, アイテム 1 を参照

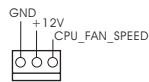

ATX パワーコネクタ

(24ピン ATXPWR1)

ページ2, アイテム 8 を参照

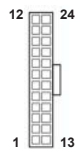

ATX 電源コネクタを接続します。



このマザーボードには24ピンATX電源コネクタが装備されており、従来の20ピンATX電源装置を採用している場合でも作動します。20ピンATX電源を使用するには、ピン1およびピン13と共に電源装置にプラグを差し込みます。

20ピンATX電源装置の取り付け

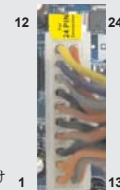

ATX 12V コネクタ
(8ピン ATX12V1)
ページ2, アイテム 4 を参照



ATX 電 12V 源コネクタを接続します。



このマザーボードで 8-pin ATX 12V 電源コネクタが提供されたが、従来の 4-pin ATX 12V 電源でも動作できます。4-pin ATX 電源を使用する場合、電源を Pin 1 と Pin 5 とともに差し込んでください。



4-Pin ATX 12V 電源の取り付け

シリアルポートヘッダ
(9ピン COM1)
ページ2, アイテム 27 を参照

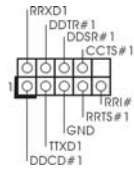

この COM1 ヘッダは、シリアルポートモジュールをサポートします。

HDMI_SPDIF ヘッダ
(2-ピン HDMI_SPDIF1)
ページ2, アイテム 34 を参照



HDMI_SPDIF ヘッダは、SPDIF 音声出力を HDMI VGA カードに提供し、システムで HDMI デジタル TV/ プロジェクタ /LCD デバイスに接続できるようにします。HDMI VGA カードの HDMI_SPDIF コネクタを、このヘッダに接続してください。

2. BIOS 情報

BIOS セットアップユーティリティはマザーボードのフラッシュメモリに保存されています。コンピュータを起動させた後、POST(パワーオンセルフテスト)中に〈F2〉または〈Del〉を押し、BIOS セットアップユーティリティに入ってください。押さない場合、POST はテストルーチンが続けます。テストを実行した後に BIOS セットアップユーティリティに入りたい場合、POST 終了後〈Ctrl〉+〈Alt〉+〈Delete〉を押すか、ケースのリセットスイッチを押してシステムを再起動してください。BIOS セットアップユーティリティは、ユーザーフレンドリであることを目指しています。これはメニュー方式のプログラムです。スクロールさせることで様々なサブメニューを表示し、かつあらかじめ定義した選択肢から選択することが可能です。BIOS セットアップの詳細な情報については、サポート CD 内のユーザーズマニュアル (PDF ファイル) をごらんください。

3. ソフトウェア サポート CD 情報

このマザーボードは Microsoft® Windows® 7 / 7 64-bit / Vista™ / Vista™ 64-bit / XP / XP 64-bit といった様々なマイクロソフト ウィンドウズ オペレーティングシステムをサポートします。マザーボードに付属しているサポート CD はマザーボードの特徴を有効にするために必要なドライバやユーティリティを含んでいます。サポート CD を使用するには、CDROM ドライブに CD を挿入してください。AUTORUN 機能が有効な場合、自動的にメインメニューが立ち上がります。AUTORUN 機能が無効な場合、サポート CD 内の BIN フォルダにある ASSETUP.EXE をダブルクリックすることにより、メインメニューが立ち上がります。

1. 主板简介

谢谢你采用了华擎 **Z77 Pro4-M** 主板，本主板由华擎严格制造，质量可靠，稳定性好，能够获得卓越的性能。本安装指南介绍了安装主板的步骤。更加详细的主板信息可参看驱动光盘的用户手册。



由于主板规格和 BIOS 软件将不断升级，本手册之相关内容变更恕不另行通知。请留意华擎网站上公布的升级版本。你也可以在华擎网站找到最新的显卡和 CPU 支持表。

华擎网址：<http://www.asrock.com>

如果您需要与此主板有关的技术支持，请参观我们的网站以了解您使用机种的规格信息。

www.asrock.com/support/index.asp

1.1 包装盒内物品

华擎 **Z77 Pro4-M** 主板

(Micro ATX 规格：9.6 英寸 X 9.6 英寸，24.4 厘米 X 24.4 厘米)

华擎 **Z77 Pro4-M** 快速安装指南

华擎 **Z77 Pro4-M** 支持光盘

两条 Serial ATA(SATA) 数据线 (选配)

一块 I/O 挡板



ASRock提醒您...

为了在 Windows® 7 / 7 64-bit / Vista™ / Vista™ 64-bit 系统中取得更好的性能，建议在 BIOS 中将 Storage Configuration (存储配置) 选项设成 AHCI 模式。关于 BIOS 设置程序，请参见支持光盘中的“User Manual”以了解相详细信息。

1.2 主板规格

架构	<ul style="list-style-type: none"> - Micro ATX 规格：9.6 英寸 X 9.6 英寸，24.4 厘米 X 24.4 厘米 - 全固态电容设计（100% 日制高品质高传导性固态电容）
处理器	<ul style="list-style-type: none"> - 支持第三代和二代 Intel® Core™ i7 / i5 / i3 处理器（LGA1155 针脚） - Digi 电源设计 - 4 + 2 电源相位设计 - 支持 Intel® Turbo Boost 2.0 技术 - 支持 K- 系列解锁的 CPU - 支持 Hyper-Threading 超线程技术（详见警告 1） - Intel® Ivy Bridge CPU 支持 Intel® 快速启动技术和 Intel® 智能连接技术
芯片组	<ul style="list-style-type: none"> - Intel® Z77
系统内存	<ul style="list-style-type: none"> - 支持双通道 DDR3 内存技术（见警告 2） - 配备四个 DDR3 DIMM 插槽 - 支持 DDR3 2800+(超频)/2400(超频)/2133(超频)/1866(超频)/1600/1333/1066 non-ECC、un-buffered 内存 - 最高支持 32GB 系统容量（见警告 3） - 支持 Intel® Extreme Memory Profile(XMP)1.3/1.2
扩展插槽	<ul style="list-style-type: none"> - 1 x PCI Express 3.0 x16 插槽 (PCIe1: x16 模式) (见警告 4) * 使用 Intel® Ivy Bridge CPU 方可支持 PCIe 3.0。若使用 Intel® Sandy Bridge CPU, 仅支持 PCIe 2.0。 - 2 x PCI Express 2.0 x16 插槽 (PCIe3: x1 模式, PCIe4: x4 模式) - 1 x PCI Express 2.0 x1 插槽 - 支持 AMD Quad CrossFireX™ 和 CrossFireX™ 技术
板载显卡	<ul style="list-style-type: none"> * 仅内置 GPU 的处理器可支持 Intel® HD Graphics 内置视觉特性与 VGA 输出。 - 支持 Intel® HD Graphics 内置视觉特性: Intel® Quick Sync Video 2.0、Intel® InTru™ 3D、Intel® Clear Video HD 技术、Intel® Insider™、Intel® HD Graphics 2500/4000 - Intel® Ivy Bridge CPU 支持 Pixel Shader 5.0、DirectX 11 技术。Intel® Sandy Bridge CPU 支持 Pixel Shader 4.1、DirectX 10.1 技术 - 最大共享内存 1760MB（见警告 5） - 支持三个 VGA 输出选项: D-Sub、DVI-D 和 HDMI（见警告 6） - 支持 HDMI 1.4a, 最高分辨率达 1920x1200 @ 60Hz - 支持 DVI, 最高分辨率达 1920x1200 @ 60Hz - 支持 D-Sub, 最高分辨率达 2048x1536 @ 75Hz

	<ul style="list-style-type: none"> - 支持 HDMI, 可支持 Auto Lip Sync、Deep Color (12bpc)、xvYCC 与 HBR(高位速音频)(需配备兼容 HDMI 的显示器) (详见警告 7) - 通过 DVI 和 HDMI 接口支持 HDCP 功能 - 通过 DVI 和 HDMI 接口可播放 1080 线蓝光光盘 (BD) / HD-DVD 光盘
音效	<ul style="list-style-type: none"> - 7.1 声道高保真音频, 支持内容保护功能 (Realtek ALC892 音频编解码器) - 支持优质蓝光音效 - 支持 THX TruStudio™
板载 LAN 功能	<ul style="list-style-type: none"> - PCIE x1 Gigabit LAN 10/100/1000 Mb/s - Realtek RTL8111E - 支持网路唤醒 (Wake-On-LAN) - 支持网路线侦测功能 - 支持 Energy Efficient Ethernet 802.3az - 支持 PXE
Rear Panel I/O (后面板输入/ 输出接口)	<p>I/O 界面</p> <ul style="list-style-type: none"> - 1 个 PS/2 键盘接口 - 1 个 D-Sub 接口 - 1 个 DVI-D 接口 - 1 个 HDMI 接口 - 1 个光纤 SPDIF 输出接口 - 4 个可直接使用的 USB 2.0 接口 - 1 个 eSATA3 接口 - 2 个可直接使用的 USB 3.0 接口 - 1 个 RJ-45 局域网接口与 LED 指示灯 (ACT/LINK LED 和 SPEED LED) - 高保真音频插孔: 后置喇叭 / 中置喇叭 / 低音喇叭 / 音频输入 / 前置喇叭 / 麦克风 (见警告 8)
SATA3	<ul style="list-style-type: none"> - 2 x Intel® Z77 的 SATA3 6.0Gb/s 连接头, 支持 RAID (RAID 0, RAID 1, RAID 5, RAID 10, Intel Rapid Storage 和 Intel Smart Response 技术), NCQ, AHCI 和热插拔功能 - 2 x ASMedia ASM1061 的 SATA3 6.0Gb/s 连接头, 支持 NCQ, AHCI 和热插拔功能 (SATA3_A1 连接头和 eSATA3 接口共享资源)
USB 3.0	<ul style="list-style-type: none"> - 2 x 后置 USB 3.0 接口, 支持 USB 1.0/2.0/3.0 到 5Gb/s - 1 x 前置 USB 3.0 接针 (支持 2 个 USB 3.0 接口), 支持 USB 1.0/2.0/3.0 到 5Gb/s
连接头	<ul style="list-style-type: none"> - 4 x SATA2 3.0Gb/s 连接头, 支持 RAID (RAID 0, RAID 1, RAID 5, RAID 10, Intel Rapid Storage 和 Intel Smart Response 技术), NCQ, AHCI 和热插拔功能 - 4 x SATA3 6.0Gb/s 连接头

	<ul style="list-style-type: none"> - 1 x 红外线模块接头 - 1 x 消费类红外线模块接头 - 1 x 打印机端口接针 - 1 x 串行接口 - 1 x HDMI_SPDIF 接头 - 1 x 电源指示灯连接排针 - CPU/ 机箱 / 电源风扇接头 - 24 针 ATX 电源接头 - 8 针 12V 电源接头 - 前置音频面板接头 - 3 x USB 2.0 接针 (可支持 6 个额外的 USB 2.0 接口) - 1 x USB 3.0 接针 (可支持 2 个额外的 USB 3.0 接口)
BIOS	<ul style="list-style-type: none"> - 64Mb AMI UEFI Legal BIOS, 支持 GUI - 支持即插即用 (Plug and Play,PnP) - ACPI 1.1 电源管理 - 支持 jumperfree 免跳线模式 - 支持 SMBIOS 2.3.1 - CPU Core, IGPU, DRAM, 1.8V PLL, VTT, VCCSA 电压多功能调节器
支持光盘	<ul style="list-style-type: none"> - 驱动程序, 工具软件, 杀毒软件 (测试版本),CyberLink MediaEspresso 6.5 试用版, 华擎 MAGIX 多媒体套件 - OEM
独家功能	<ul style="list-style-type: none"> - ASRock Extreme Tuning Utility (AXTU) (详见警告 9) - 华擎即时开机功能 - 华擎 Instant Flash (见警告 10) - 华擎 APP Charger (见警告 11) - 华擎 SmartView (见警告 12) - 华擎 XFast USB (见警告 13) - 华擎 XFast LAN (见警告 14) - 华擎 XFast RAM (见警告 15) - 华擎 Crashless BIOS (见警告 16) - 华擎 OMG (Online Management Guard) (见警告 17) - Lucid Virtu Universal MVP (见警告 18) - * 仅内置 GPU 的处理器可支持 Lucid Virtu Universal MVP。 - 华擎开 / 关播放技术 (见警告 19) - Hybrid Booster(安心超频技术): <ul style="list-style-type: none"> - 支持 CPU 无级频率调控 (见警告 20) - ASRock U-COP (见警告 21) - Boot Failure Guard (B.F.G., 启动失败恢复技术) - 组合散热器选项 (C.C.O.) (见警告 22) - 晚安指示灯
硬件监控器	<ul style="list-style-type: none"> - CPU 温度侦测 - 主板温度侦测

	<ul style="list-style-type: none"> - CPU/ 机箱 / 电源风扇转速计 - CPU/ 机箱静音风扇 (允许根据 CPU 温度自动调整机箱风扇速度) - CPU/ 机箱风扇多速控制 - 电压范围: +12V, +5V, +3.3V, 核心电压
操作系统	- Microsoft® Windows® 7/7 64 位元 / Vista™ / Vista™ 64 位元 / XP/XP 64 位元适用于此主板 (见警告 23)
认证	<ul style="list-style-type: none"> - FCC, CE, WHQL - 支持 ErP/EuP (需要同时使用支持 ErP/EuP 的电源供应器) (见警告 24)

* 请参阅华擎网站了解详细的产品信息: <http://www.asrock.com>

警告

请了解超频具有不可避免的风险, 这些超频包括调节 BIOS 设置、运用异步超频技术或使用第三方超频工具。超频可能会影响您的系统稳定性, 甚至会导致系统组件和设备的损坏。这种风险和代价须由您自己承担, 我们对超频可能导致的损坏不承担责任。

警告!

- 1、关于“Hyper-Threading Technology” (超线程技术) 的设置, 请参考 CD 光盘中的“User Manual”第 52 页。
- 2、这款主板支援双通道内存技术。在您实现双通道内存技术之前, 为能正确安装, 请确认您已经阅读了第 17 页的内存模组安装指南。
- 3、由于操作系统的限制, 在 Windows® 7 / Vista™ / XP 下, 供系统使用的实际内存容量可能小于 4GB。对于 Windows® 操作系统搭配 64 位元 CPU 来说, 不会存在这样的限制。您可以通过华擎 XFast RAM 来利用 Windows® 无法使用的内存。
- 4、只有 PCIe1 插槽支持 Gen 3 速度。若要使 PCI Express 运行于 Gen 3 速度, 您必须安装 Ivy Bridge CPU。若您安装了 Sandy Bridge CPU, 则 PCI Express 只能运行于 Gen 2 速度。
- 5、最大共享内存大小由芯片组厂商定义并且可以更改。请查阅 Intel® 网站了解最新资讯。
- 6、您只能从三种显示器中选择两种使用。D-Sub、DVI-D 与 HDMI 显示器不能同时使用。此外, 使用 DVI 转 HDMI 转接器, 可使 DVI-D 端口具备与 HDMI 端口一样的功能。
- 7、只有 Windows® 7 64 位元 / 7 可支持 xvYCC 与 Deep Color。只有当显示器在 EDID 中支持 12bpc 时, Deep Color 模式才会被开启。只有 Windows® 7 64 位元 / 7 / Vista™ 64 位元 / Vista™ 支持 HBR。
- 8、在麦克风输入方面, 这款主板支持立体声和单声道这两种模式。在音频输出方面, 这款主板支持 2 声道、4 声道、6 声道以及 8 声道模式。请查阅第 3 页的表格了解正确的连接方式。





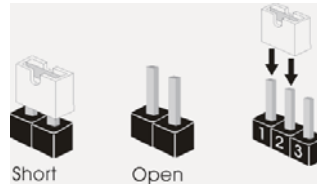

- 9、ASRock Extreme Tuning Utility (AXTU) 是一个多合一的工具，可在用户友好的界面中微调不同的系统功能，包括硬件监控、风扇控制、超频、OC DNA 和 IES。在 Hardware Monitor (硬件监控) 中，显示系统的主要参数。在 Fan Control (风扇控制) 中，显示风扇速度和温度，以便您进行调整。在 Overclocking (超频) 中，您可以对 CPU 进行超频，以优化系统性能。在 OC DNA 中，您可以将自己的 OC 设置保存为配置文件，并与您的朋友共享。您的朋友可以将您的 OC 配置文件加载他们的系统中，从而得到相同的 OC 设置。在 IES (智能节能) 中，电压调节器可以在 CPU 核心空闲时减少输出相位数，以提高效率且不影响运算性能。关于 ASRock Extreme Tuning Utility (AXTU) 的操作步骤，请访问我们的网站。
华擎网站：<http://www.asrock.com>
- 10、华擎 Instant Flash 是一个内建于 Flash ROM 的 BIOS 更新工具程序。这个方便的 BIOS 更新工具可让您无需进入操作系统 (如 MS-DOS 或 Windows®) 即可进行 BIOS 的更新。在系统开机自检过程中按下 <F6> 键或在 BIOS 设置菜单中按下 <F2> 键即可进入华擎 Instant Flash 工具程序。启动这一程序后，只需把新的 BIOS 文件保存在 U 盘、软盘或硬盘中，轻松点击鼠标就能完成 BIOS 的更新，而不再需要准备额外的软盘或其他复杂的更新程序。请注意：U 盘或硬盘必须使用 FAT32/64 文件系统。
- 11、若您想要更快速、更自由地为您的苹果设备，如 iPhone/iPad/iPod touch 充电，华擎为您提供了一个绝妙的解决方案 - 华擎 APP Charger。只需安装 APP Charger 驱动程序，用电脑为 iPhone 充电最多可比以往快 40%。华擎 APP Charger 允许您同时为多部苹果设备快速充电，甚至可以在电脑进入待机 (S1)、挂起至内存 (S3)、休眠 (S4) 或关机 (S5) 模式下持续为设备充电。只需安装了 APP Charger 驱动程序，您立刻就能拥有非凡的充电体验。
- 12、SmartView 是 Internet 浏览器的一项新功能，它作为 IE 的智能起始页面，在一个增强的视图中提供您经常访问的网站、您的游览历史记录、您的 Facebook 朋友、以及您的实时新闻来源，可为您提供更具个性化的 Internet 体验。华擎主板专门配备 SmartView 应用程序，可帮助您随时与朋友保持联系。为使用 SmartView 功能，请确保您操作系统的版本是 Windows® 7 / 7 64 位元 / Vista™ / Vista™ 64 位元，浏览器的版本是 IE8。
华擎网站：<http://www.asrock.com/Feature/SmartView/index.asp>
- 13、华擎 XFast USB 可以提升 USB 存储设备性能。性能可能因设备特性不同而存在差异。
- 14、华擎 XFast LAN 可提供更快的网络访问，包括以下诸多好处。网络应用程序优先级：您可以设置理想的应用程序优先级，并可以添加新程序。游戏更少延迟：将在线游戏设置为较高的优先级，可降低游戏中的延迟。流量定形：您可以在观看 Youtube 高清视频的同时进行文件下载。实时分析您的数据：通过状态窗口，您可以清楚地看到目前正在传输的是哪个数据流。
- 15、华擎 XFast RAM 是 ASRock Extreme Tuning Utility (AXTU) 中加入的一项新功能。它能充分利用 Windows® 操作系统 32-bit CPU 无法使用的内存空间。华擎 XFast RAM 可缩短之前访问过的网站的加载时间，从而加快网络冲浪速度。此外，它还能提升 Adobe Photoshop 运行的速度高达五倍之多。华擎 XFast RAM 的另一项优势是它能减少访问 SSD 或 HDD 的频次，从而延长它们的使用寿命。

- 16、华擎 Crashless BIOS 能让用户安心地更新他们的 BIOS，而不用担心发生故障。如果在 BIOS 更新过程中断电，华擎 Crashless BIOS 会在电源恢复后自动完成 BIOS 更新过程。请注意，BIOS 文件需存放在 USB 盘的根目录中。此功能只支持 USB2.0 端口。
- 17、管理员可通过 OMG 对指定的时间段对互联网设置禁用或限制访问。您可以选择 [Everyday] (每天)，[Day of the week] (指定星期几) 或 [Weekdays and weekends] (指定工作日或周末)，然后设置授权允许其他用户访问互联网的起始时间和结束时间。为防止用户绕过 OMG 的管控，必须新增无权更改系统时间的访客帐户。
- 18、VIRTU Universal MVP 包括 Virtu 通用技术的基本功能，可虚拟化集成的 GPU 和离散 GPU，使 Breed 功能达到最佳效果。此外，它还采用 Virtual Vsync™ 技术，提供优异的视觉效果。利用 HyperFormance 技术所带来的优点，VIRTU Universal MVP 通过智能地减少 CPU、GPU 和显示器之间数据流的冗余渲染任务，提高游戏性能。
- 19、华擎开 / 关播放技术能让用户通过将便携式音频设备（如 MP3 播放器或移动电话）连接到 PC 来享受美好的音频体验，即使 PC 处于关机状态（或处于 ACPI S5 模式）也没关系！此主板还提供一条免费 3.5mm 音频线（选购），确保用户建立最方便的计算环境。
- 20、尽管本主板提供无级频率调控，但不推荐用户超频使用。不同于标准 CPU 总线频率的非标准频率可能会使系统不稳定，甚至会损害 CPU 和主板。
- 21、当检测到 CPU 过热问题时，系统会自动关机。在您重新启动系统之前，请检查主板上的 CPU 风扇是否正常运转并拔出电源线，然后再将它插回。为了提高散热性，在安装 PC 系统时请在 CPU 和散热器之间涂一层导热胶。
- 22、组合散热器选项 (C.C.O.) 提供灵活的选项，让您可使用三种不同的 CPU 散热器类型，分别是 LGA775, LGA1155 与 LGA1156。请注意：并非所有的 775 和 1156 CPU 风扇都支持此功能。
- 23、Microsoft® Windows® XP / XP 64-bit 系统不支持华擎 XFast RAM。Microsoft® Windows® Vista™ / Vista™ 64-bit / XP / XP 64-bit 系统不支持 Intel® 智能连接技术和 Intel® USB 3.0 连接头。
- 24、EuP, 全称 Energy Using Product (能耗产品)，是欧盟用来定义完整系统耗电量的规定。根据 EuP 的规定，一个完整系统在关机模式下的交流电总消耗必须在 1.00W 以下。为满足 EuP 标准，您需要同时具备支持 EuP 的主板和支持 EuP 的电源供应器。根据 Intel® 的建议，支持 EuP 的电源供应器必须满足在 100mA 电流消耗时，5Vsb 电源效率高于 50%。有关支持 EuP 的电源供应器选择方面的更多细节，我们建议您咨询电源供应器的制造商。

1.3 跳线设置

插图所示的就是设置跳线的方法。当跳线帽放置在针脚上时，这个跳线就是“短接”。如果针脚上没有放置跳线帽，这个跳线就是“开路”。插图显示了一个 3 针脚的跳线，当跳线帽放置在针脚 1 和针脚 2 之间时就是“短接”。



接脚	设定		
清除 CMOS (CLRCMOS1, 3 针脚跳线) (见第 2 页第 15 项)	<table border="0"><tr><td style="text-align: center;">1_2  默认设置</td><td style="text-align: center;">2_3  清除 CMOS</td></tr></table>	1_2  默认设置	2_3  清除 CMOS
1_2  默认设置	2_3  清除 CMOS		

注意：CLRCMOS1 允许您清除 CMOS 中的数据。如要清除并将系统参数恢复至默认设置，请关闭计算机，然后从电源插座上拔掉电源线。等待 15 秒后，使用跳线帽将 CLRCMOS1 上的插针 2 和插针 3 短接 5 秒。但是，请勿在更新 BIOS 后立即清除 CMOS。如果需要在更新 BIOS 后立即清除 CMOS，必须在执行 CMOS 清除操作之前，先启动然后关闭系统。请注意，只有取出 CMOS 电池，密码、日期、时间、用户默认配置文件、1394 GUID 和 MAC 地址才会被清除。

1.4 板载接头和接口



板载接头和接口不是跳线。切勿将跳线帽放置在这些接头和接口上。将跳线帽放置在接头和接口上将会导致主板的永久性损坏！

Serial ATA2 接口

(SATA2_2_3: 见第 2 页第 14 项)
(SATA2_4: 见第 2 页第 21 项)
(SATA2_5: 见第 2 页第 20 项)

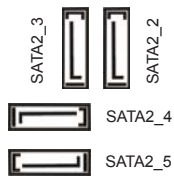

这里有四组 Serial ATA2 (SATA2) 接口支持 Serial (SATA) 数据线作为内部储存设置。目前 SATA2 界面理论上可提供高达 3.0Gb/s 的数据传输速率。

Serial ATA3 接口

(SATA3_A0_A1: 见第 2 页第 12 项)
(SATA3_0_1: 见第 2 页第 13 项)

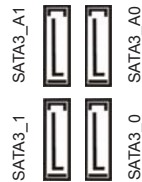

这里有四组 Serial ATA3 (SATA3) 接口支持 Serial (SATA) 数据线作为内部储存设置。目前 SATA3 界面理论上可提供高达 6.0Gb/s 的数据传输速率。如果后部 I/O 上的 eSATA3 端口已连接，内部 SATA3_A1 将不起作用。

Serial ATA (SATA) 数据线 (选配)



SATA 数据线的任意一端均可连接 SATA/SATA2/SATA3 硬盘或者主板上的 SATA2/SATA3 接口。

打印机端口接针

(25 针 LPT1)
(见第 2 页第 28 项)

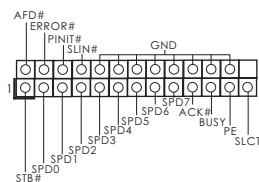

这是一个连接打印机端口的接口，方便您连接打印机设备。

USB 2.0 扩展接头
(9 针 USB_6_7)
(见第 2 页第 25 项)

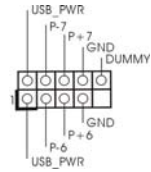

除了位於 I/O 面板的四个默认 USB 2.0 接口之外，这款主板有三组 USB 2.0 接针。这组 USB 2.0 接针可以支持两个 USB 2.0 接口。

(9 针 USB_8_9)
(见第 2 页第 24 项)

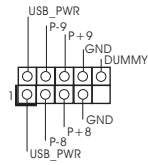

(9 针 USB_10_11)
(见第 2 页第 23 项)

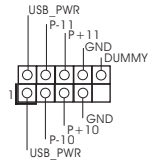

USB 3.0 扩展接头
(19 针 USB3_12_13)
(见第 2 页第 9 项)

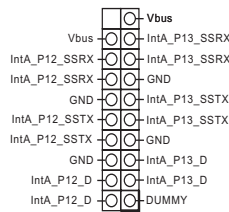

除了位於 I/O 面板的两个默认 USB 3.0 接口之外，这款主板有一组 USB 3.0 接针。这组 USB 3.0 接针可以支持两个 USB 3.0 接口。

红外线模块接头
(5 针 IR1)
(见第 2 页第 19 项)

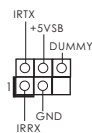

这个接头支持一个选配的无线发送和接受红外线的模块。

消费类红外线模块接头
(4 针 CIR1)
(见第 2 页第 26 项)

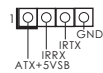

此接口可以连接遥控器。

前置音频面板接头

(9 针 HD_AUD101)
(见第 2 页第 33 项)

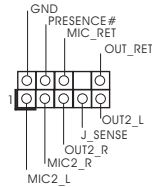

可以方便连接音频设备。



1. 高保真音频 (High Definition Audio, HDA) 支持智能音频接口检测功能 (Jack Sensing), 但是机箱面板的连线必须支持 HDA 才能正常使用。请按我们提供的手册和机箱手册上的使用说明安装您的系统。2. 如果您使用 AC' 97 音频面板, 请按照下面的步骤将它安装到前面板音频接头:

- 将 Mic_IN(MIC) 连接到 MIC2_L。
- 将 Audio_R(RIN) 连接到 OUT2_R, 将 Audio_L(LIN) 连接到 OUT2_L。
- 将 Ground(GND) 连接到 Ground(GND)。
- MIC_RET 和 OUT_RET 仅用于 HD 音频面板。您不必将它们连接到 AC' 97 音频面板。
- 开启前置麦克风。

在 Windows® XP / XP 64 位元操作系统中:

选择” Mixer”。选择” Recorder”。接著点击” FrontMic”。

在 Windows® 7 / 7 64 位元 / Vista™ / Vista™ 64 位元操作系统中:

在 Realtek 控制面板中点击” FrontMic”。调节” Recording Volume”。

系统面板接头

(9 针 PANEL1)
(见第 2 页第 18 项)

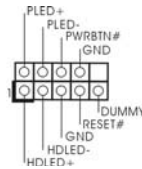

这个接头提供数个系统前面板功能。



根据下面的针脚说明连接机箱上的电源开关、重启按钮与系统状态指示灯到这个排针。根据之前请注意针脚的正负极。

PWRBTN (电源开关):

连接机箱前面板的电源开关。您可以设置用电源键关闭系统的方式。

RESET (重启开关):

连接机箱前面板的重启开关。当电脑死机且无法正常重新启动时, 可按下重启开关重新启动电脑。

PLED (系统电源指示灯):

连接机箱前面板的电源状态指示灯。当系统运行时, 此指示灯亮起。当系统处于 S1/S3 待机模式时, 此指示灯保持闪烁。当系统处于 S4 待机模式或关机 (S5) 模式时, 此指示灯熄灭。

HD LED (硬盘活动指示灯):

连接机箱前面板的硬盘动作指示灯。当硬盘正在读取或写入数据时, 此指示灯亮起。

前面板设计因机箱不同而有差异。前面板模块一般由电源开关、重启开关、电源指示灯、硬盘动作指示灯、喇叭等构成。将您的机箱前面板连接到此排针时，请确认连接线与针脚上的说明相对应。

机箱喇叭接头
(4 针 SPEAKER1)
(见第 2 页第 16 项)

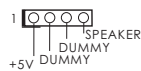

请将机箱喇叭连接到这个接头。

电源指示灯连接排针
(3 针 PLED1)
(见第 2 页第 17 项)



请将机箱电源指示灯连接到这一排针，以指示系统电源状态。当系统正在运行时，LED 指示灯亮。在 S1/S3 模式下，LED 指示灯会不停闪烁。在 S3/S4 或 S5 模式（关机）下，LED 指示灯会熄灭。

机箱，电源风扇接头
(4 针 CHA_FAN1)
(见第 2 页第 22 项)

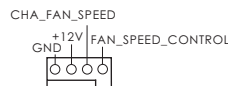

请将风扇连接线接到这个接头，并让黑线与接地的针脚相接。CHA_FAN1 和 CHA_FAN2 支持风扇控制。

(3 针 CHA_FAN2)
(见第 2 页第 35 项)

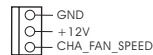

(3 针 PWR_FAN1)
(见第 2 页第 2 项)

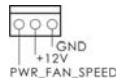

CPU 风扇接头
(4 针 CPU_FAN1)
(见第 2 页第 3 项)

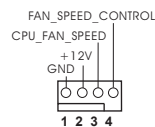

请将 CPU 风扇连接线接到这个接头，让黑线与接地的针脚相接。



虽然此主板支持 4-Pin CPU 风扇 (Quiet Fan, 静音风扇)，但是没有调速功能的 3-Pin CPU 风扇仍然可以在此主板上正常运行。如果您打算将 3-Pin CPU 风扇连接到此主板的 CPU 风扇接口，请将它连接到 Pin 1-3。

Pin 1-3 连接
3-Pin 风扇的安装

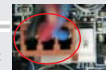

简体中文

(3 针 CPU_FAN2)
(见第 2 页第 1 项)

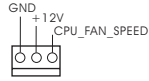

ATX 电源接头
(24 针 ATXPWR1)
(见第 2 页第 8 项)

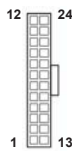

请将 ATX 电源供应器连接到这个接头。



虽然此主板提供 24-pin ATX 电源接口，但是您仍然可以使用传统的 20-pin ATX 电源。为了使用 20-pin ATX 电源，请顺著 Pin 1 和 Pin 13 插上电源接头。

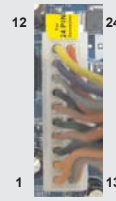

20-Pin ATX 电源安装说明

ATX 12V 接头
(8 针 ATX12V1)
(见第 2 页第 4 项)



请将一个 ATX 12V 电源供应器接到这个接头。



虽然此主板提供 8-pin ATX 12V 电源接口，但是您仍然可以使用传统的 4-pin ATX 12V 电源。为了使用 4-pin ATX 12V 电源，请顺著 Pin 1 和 Pin 5 插上电源接头。



4-Pin ATX 12V 电源安装说明

串行接口连接器
(9 针 COM1)
(见第 2 页第 27 项)

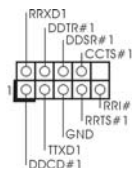

这个 COM1 端口支持一个串行接口的 外设。

HDMI_SPDIF 接头
(2 针 HDMI_SPDIF1)
(见第 2 页第 34 项)



HDMI_SPDIF 接头，提供 SPDIF 音频输出至 HDMI 显卡，支持将电脑连接至带 HDMI 的数字电视 / 投影仪 / 液晶显示器等设备。请将 HDMI 显卡的 HDMI_SPDIF 接口连接到这个接头。

2. BIOS 信息

主板上的 Flash Memory 存储了 BIOS 设置程序。请再启动电脑进行开机自检 (POST) 时按下 <F2> 或 键进入 BIOS 设置程序；此外，你也可以让开机自检 (POST) 进行常规检验。如果你需要在开机自检 (POST) 之后进入 BIOS 设置程序，请按下 <Ctrl>+<Alt>+<Delete> 键重新启动电脑，或者按下系统面板上的重启按钮。有关 BIOS 设置的详细信息，请查阅随机支持光盘里的用户手册 (PDF 文件)。

3. 支持光盘信息

本主板支持各种微软视窗操作系统：Microsoft® Windows® 7/7 64 位元 /Vista™/Vista™ 64 位元 /XP/XP 64 位元。主板随机支持光盘包含各种有助于提高主板效能的必要驱动和实用程序。请将随机支持光盘放入光驱里，如果电脑的“自动运行”功能已启用，屏幕将会自动显示主菜单。如果主菜单不能自动显示，请查找支持光盘内 BIN 文件夹下的“ASSETUP.EXE”，并双击它，即可调出主菜单。

电子信息产品污染控制标示

依据中国发布的「电子信息产品污染控制管理办法」及 SJ/T 11364-2006「电子信息产品污染控制标示要求」，电子信息产品应进行标示，藉以向消费者揭露产品中含有的有毒有害物质或元素不致发生外泄或突变从而对环境造成污染或对人身、财产造成严重损害的期限。依上述规定，您可于本产品之印刷电路板上看见图一之标示。图一中之数字为产品之环保使用期限。由此可知此主板之环保使用期限为 10 年。



图一

有毒有害物质或元素的名称及含量说明

若您欲了解此产品的有毒有害物质或元素的名称及含量说明，请参照以下表格及说明。

部件名称	有害物质或元素					
	铅 (Pb)	镉 (Cd)	汞 (Hg)	六价铬 (Cr (VI))	多溴联苯 (PBB)	多溴二苯醚 (PBDE)
印刷电路板及电子组件	X	O	O	O	O	O
外部信号连接头及线材	X	O	O	O	O	O

O: 表示该有毒有害物质在该部件所有均质材料中的含量均在 SJ/T 11363-2006 标准规定的限量要求以下。

X: 表示该有毒有害物质至少在该部件的某一均质材料中的含量超出 SJ/T 11363-2006 标准规定的限量要求，然该部件仍符合欧盟指令 2002/95/EC 的规范。

备注：此产品所标示之环保使用年限，系指在一般正常使用状况下。

1. 主機板簡介

謝謝你採用了華擎 **Z77 Pro4-M** 主機板，本主機板由華擎嚴格製造，品質可靠，穩定性好，能夠獲得卓越的性能。此快速安裝指南包括了主機板介紹和分步驟安裝指導。您可以查看支持光碟裡的使用手冊了解更詳細的資料。



由於主機板規格和 BIOS 軟體將不斷更新，本手冊之相關內容變更恕不另行通知。請留意華擎網站上公布的更新版本。你也可以在華擎網站找到最新的顯示卡和 CPU 支援列表。

華擎網址：<http://www.asrock.com>

如果您需要與此主機板有關的技術支援，請參觀我們的網站以了解您使用機種的規格訊息。

www.asrock.com/support/index.asp

1.1 包裝盒內物品

華擎 **Z77 Pro4-M** 主機板

(Micro ATX 規格：9.6 英吋 x 9.6 英吋，24.4 公分 x 24.4 公分)

華擎 **Z77 Pro4-M** 快速安裝指南

華擎 **Z77 Pro4-M** 支援光碟

兩條 Serial ATA(SATA) 數據線 (選配)

一塊 I/O 擋板



ASRock提醒您...

若要在 Windows® 7 / 7 64位元 / Vista™ / Vista™ 64位元中發揮更好的效能，建議您將儲存裝置組態中的 BIOS 選項設為 AHCI 模式。有關 BIOS 設定的詳細資訊，請參閱支援光碟中的「使用者手冊」。

1.2 主機板規格

架構	<ul style="list-style-type: none"> - Micro ATX 規格： 9.6 英吋 x 9.6 英吋，24.4 公分 x 24.4 公分 - 全固態電容設計（百分百日本製造的高品質導電高分子電容器）
處理器	<ul style="list-style-type: none"> - 支援第三代和二代 Intel® Core™ i7 / i5 / i3 處理器（LGA1155 腳位） - Digi 電源設計 - 4 + 2 電源相位設計 - 支援 Intel® Turbo Boost 2.0 技術 - 支援 K 系列解除鎖定 CPU - 支援 Hyper-Threading 技術（詳見警告 1） - Intel® Ivy Bridge CPU 支援 Intel® 快速啟動技術和 Intel® 智能連接技術
晶片組	<ul style="list-style-type: none"> - Intel® Z77
系統記憶體	<ul style="list-style-type: none"> - 支援雙通道 DDR3 記憶體技術（見警告 2） - 4 個 DDR3 DIMM 插槽 - 支援 DDR3 2800+(超頻)/2400(超頻)/2133(超頻)/1866(超頻)/1600/1333/1066 non-ECC、un-buffered 記憶體 - 最高支援 32GB 系統容量（見警告 3） - 支援 Intel® Extreme Memory Profile(XMP)1.3/1.2
擴充插槽	<ul style="list-style-type: none"> - 1 x PCI Express 3.0 x16 插槽 (PCIe1:x16 模式) (見警告 4) * PCIe 3.0 僅適用 Intel® Ivy Bridge CPU。Intel® Sandy Bridge CPU 僅支援 PCIe 2.0。 - 2 x PCI Express 2.0 x16 插槽 (PCIe3:x1 模式；PCIe4:x4 模式) - 1 x PCI Express 2.0 x1 插槽 - 支援 AMD Quad CrossFire™ 和 CrossFire™ 技術
內建顯示	<ul style="list-style-type: none"> * 只有整合 GPU 的處理器才支援 Intel® HD Graphics 內建視覺技術 (Built-in Visuals) 與 VGA 輸出。 - 支援 Intel® HD Graphics 內建視覺技術 (Built-in Visuals)：Intel® Quick Sync Video 2.0、Intel® InTru™ 3D、Intel® Clear Video HD Technology、Intel® Insider™、Intel® HD Graphics 2500/4000 - Intel® Ivy Bridge CPU 支援 Pixel Shader 5.0、DirectX 11 技術。Intel® Sandy Bridge CPU 支援 Pixel Shader 4.1、DirectX 10.1 技術 - 最大共享記憶體 1760MB（見警告 5） - 支援三個 VGA 輸出選項：D-Sub、DVI-D 和 HDMI（見警告 6） - 支援 HDMI 1.4a，最高解析度達 1920x1200 @ 60Hz

	<ul style="list-style-type: none"> - 支援 DVI, 最高解析度達 1920x1200 @ 60Hz - 支援 D-Sub, 最高解析度達 2048x1536 @ 75Hz - 支援 HDMI, 可支援 Auto Lip Sync、Deep Color (12bpc)、xvYCC 與 HBR(高位元率音效)(需具備相容 HDMI 的銀幕)(詳見警告 7) - DVI 和 HDMI 接口支援 HDCP 功能 - DVI 和 HDMI 接口可播放 1080p 藍光光碟 (BD) / HD-DVD 光碟
音效	<ul style="list-style-type: none"> - 7.1 聲道高清晰音效, 支援內容保護功能 (Realtek ALC892 音效編解碼器) - 支援高級藍光音效 - 支援 THX TruStudio™
網路功能	<ul style="list-style-type: none"> - PCIE x1 Gigabit LAN 10/100/1000 Mb/s - Realtek RTL8111E - 支援網路喚醒 (Wake-On-LAN) - 支援網路線偵測功能 - 支援 Energy Efficient Ethernet 802.3az - 支援 PXE
Rear Panel I/O (後背板輸入/ 輸出接口)	<p>I/O 界面</p> <ul style="list-style-type: none"> - 1 個 PS/2 鍵盤接口 - 1 個 D-Sub 接口 - 1 個 DVI-D 接口 - 1 個 HDMI 接口 - 1 個光纖 SPDIF 輸出接口 - 4 個可直接使用的 USB 2.0 接口 - 1 個 eSATA3 接口 - 2 個可直接使用的 USB 3.0 接口 - 1 個 RJ-45 區域網接口與 LED 指示燈 (ACT/LINK LED 和 SPEED LED) - 高清晰音效插孔: 後置喇叭 / 中置喇叭 / 低音喇叭 / 音效輸入 / 前置喇叭 / 麥克風 (見警告 8)
SATA3	<ul style="list-style-type: none"> - 2 x Intel® Z77 的 SATA3 6.0Gb/s 接頭, 支援 RAID (RAID 0, RAID 1, RAID 5, RAID 10, Intel Rapid Storage 和 Intel Smart Response 技術), NCQ, AHCI 和熱插拔功能 - 2 x ASMedia ASM1061 的 SATA3 6.0Gb/s 接頭, 支援 NCQ, AHCI 和熱插拔功能 (SATA3_A1 接頭和 eSATA3 接口共享資源)
USB 3.0	<ul style="list-style-type: none"> - 2 x 後置 USB 3.0 接口, 支援 USB 1.0/2.0/3.0 到 5Gb/s - 1 x 前置 USB 3.0 接頭 (支援 2 個 USB 3.0 接口), 支援 USB 1.0/2.0/3.0 到 5Gb/s
接頭	<ul style="list-style-type: none"> - 4 x SATA2 3.0Gb/s 接頭, 支援 RAID (RAID 0, RAID 1, RAID 5, RAID 10, Intel Rapid Storage 和 Intel Smart Response 技術), NCQ, AHCI 和熱插拔功能

	<ul style="list-style-type: none"> - 4 x SATA3 6.0Gb/s 接頭 - 1 x 紅外線模組接頭 - 1 x 消費性紅外線模組插座 - 1 x 印表機接針 - 1 x 序列埠 - 1 x HDMI_SPDIF 接頭 - 1 x 電源指示燈接頭 - CPU/ 機箱 / 電源風扇接頭 - 24 針 ATX 電源接頭 - 8 針 12V 電源接頭 - 前置音效接頭 - 3 x USB 2.0 接頭 (可支援 6 個額外的 USB 2.0 接口) - 1 x USB 3.0 接頭 (可支援 2 個額外的 USB 3.0 接口)
BIOS	<ul style="list-style-type: none"> - 64Mb AMI UEFI Legal BIOS (支援 GUI) - 支援即插即用 (Plug and Play, PnP) - ACPI 1.1 電源管理 - 支援 jumperfree 免跳線模式 - 支援 SMBIOS 2.3.1 - CPU Core, iGPU, DRAM, 1.8V PLL, VTT, VCCSA 電壓多功能調節
支援光碟	<ul style="list-style-type: none"> - 驅動程式, 工具軟體, 防毒軟體 (試用版本), CyberLink MediaEspresso 6.5 試用版, 華擎 MAGIX 多媒體套餐 - OEM
獨家功能	<ul style="list-style-type: none"> - ASRock Extreme Tuning Utility (AXTU) (詳見警告 9) - 華擎即時開機功能 - 華擎 Instant Flash (見警告 10) - 華擎 APP Charger (見警告 11) - 華擎 SmartView (見警告 12) - 華擎 XFast USB (見警告 13) - 華擎 XFast LAN (見警告 14) - 華擎 XFast RAM (見警告 15) - 華擎 Crashless BIOS (見警告 16) - 華擎 OMG (Online Management Guard) (見警告 17) - Lucid Virtu Universal MVP (見警告 18) * 只有整合 GPU 的處理器才支援 Lucid Virtu Universal MVP。 - 華擎 On/Off Play 技術 (見警告 19) - Hybrid Booster(安心超頻技術): <ul style="list-style-type: none"> - 支援 CPU 無級頻率調控 (見警告 20) - ASRock U-COP (見警告 21) - Boot Failure Guard (B.F.G., 啟動失敗恢復技術) - 組合散熱片選項 (C.C.O.) (見警告 22) - 晚安 LED 指示燈

硬體監控	<ul style="list-style-type: none"> - CPU 溫度偵測 - 主機板溫度偵測 - CPU/ 機箱 / 電源風扇轉速計 - CPU/ 機箱靜音風扇 (可透過 CPU 溫度自動調節機箱的風扇速度) - CPU/ 機箱風扇多速控制 - 電壓範圍: +12V, +5V, +3.3V, 核心電壓
操作系統	<ul style="list-style-type: none"> - Microsoft® Windows® 7/7 64 位元 /Vista™/Vista™ 64 位元 / XP/XP 64 位元 (見警告 23)
認證	<ul style="list-style-type: none"> - FCC, CE, WHQL - 支援 ErP/EuP (需要同時使用支援 ErP/EuP 的電源供應器) (見警告 24)

* 請參閱華擎網站了解詳細的產品訊息: <http://www.asrock.com>

警告

請了解超頻具有不可避免的風險，這些超頻包括調節 BIOS 設置、運用非同步超頻技術或使用第三方超頻工具。超頻可能會影響您的系統穩定性，甚至會導致系統組件和設備的損壞。這種風險和代價須由您自己承擔，我們對超頻可能導致的損壞不承擔責任。

警告！

- 1、關於“Hyper-Threading Technology”的設置，請參考 CD 光碟中的“User Manual”第 52 頁。
- 2、此款主機板支援雙通道記憶體技術。在您使用雙通道記憶體技術之前，為能正確安裝，請確認您已經閱讀了第 17 頁的記憶體安裝指南。
- 3、由於作業系統的限制，在 Windows® 7 / Vista™ / XP 下，供系統使用的實際記憶體容量可能小於 4GB。對於 Windows® 作業系統搭配 64 位元 CPU 來說，不會存在這樣的限制。您可以透過華擎 XFast RAM 來利用 Windows® 無法使用的記憶體。
- 4、僅 PCI-E 插槽可支援 Gen 3 速度。若要以 Gen 3 速度執行 PCI Express，請務必安裝 Ivy Bridge CPU。如果安裝 Sandy Bridge CPU，則僅能以 PCI Express Gen 2 速度執行 PCI Express。
- 5、最大共享記憶體大小由晶片組廠商定義並且可能更改。請查閱 Intel® 網站了解最新訊息。
- 6、您只能從三種銀幕中選擇兩種使用。D-Sub、DVI-D 與 HDMI 銀幕不能同時使用。此外，使用 DVI 轉 HDMI 轉接頭，可使 DVI-D 接口具有與 HDMI 接口一樣的功能。
- 7、只有 Windows® 7 64 位元 /7 可支持 xvYCC 與 Deep Color。只有當銀幕在 EDID 中支援 12bpc 時，Deep Color 模式才會被開啟。只有 Windows® 7 64 位元 /7/Vista™ 64 位元 /Vista™ 支援 HBR。
- 8、在麥克風輸入方面，此款主機板支援立體聲和單聲道這兩種模式。在音效輸出方面，此款主機板支援 2 聲道、4 聲道、6 聲道以及 8 聲道模式。請參閱第 3 頁的表格瞭解正確的連接方式。





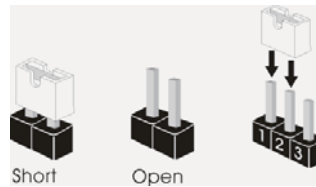

- 9、ASRock Extreme Tuning Utility (AXTU) 是一款多合一的工具，易於操作的使用者介面便於微調不同的系統功能（例如：Hardware Monitor、Fan Control、Overclocking、OC DNA 及 IES）。Hardware Monitor 可顯示系統的主要讀數；Fan Control 可顯示並可供您調整風扇速度及溫度；Overclocking 可供您進行 CPU 超頻以獲得最佳系統效能。透過 OC DNA，您可將自己的 OC 設定另存為設定檔並與朋友分享，您的朋友可將此 OC 設定檔上傳至自己的系統中，以取得相同的 OC 設定。透過 IES (Intelligent Energy Saver)，當 CPU 處於閒置狀態時，電壓調整器能降低輸出相位數量以改善效率，並可兼顧運算效能。有關 ASRock Extreme Tuning Utility (AXTU) 的操作程序說明，請造訪 ASRock 網站。
華擎網站：<http://www.asrock.com>
- 10、華擎 Instant Flash 是一個內建於 Flash ROM 的 BIOS 更新工具程式。這個方便的 BIOS 更新工具可讓您無需進入操作系統（如 MS-DOS 或 Windows®）即可進行 BIOS 的更新。在系統開機自檢過程中按下 <F6> 鍵或在 BIOS 設置菜單中按下 <F2> 鍵即可進入華擎 Instant Flash 工具程式。啟動這一程式後，只需把新的 BIOS 文件保存在隨身碟、磁盤或硬碟中，輕鬆點選滑鼠就能完成 BIOS 的更新，而不再需要準備額外的磁碟片或其他複雜的更新程式。請注意：隨身碟或硬碟必須使用 FAT32/64 文件系統。
- 11、若您想要更快速、更自由地為您的蘋果設備，如 iPhone/iPad/iPod touch 充電，華擎為您提供了一個絕妙的解決方案 - 華擎 APP Charger。只需安裝 APP Charger 驅動程式，用電腦為 iPhone 充電最多可比以往快 40%。華擎 APP Charger 讓您可以同時為多部蘋果設備快速充電，甚至可以在電腦進入待命 (S1)、待命 (S3)、休眠 (S4) 或關機 (S5) 模式下持續為設備充電。只需安裝了 APP Charger 驅動程式，您立刻就能擁有非凡的充電體驗。
- 12、SmartView 是網際網路瀏覽器的新功能，也是 IE 的起始頁面，其中結合了您最常瀏覽的網站、您的記錄、Facebook 朋友和即時新聞摘要，並全數整合在一個更好的檢視中，以提供更貼近您個人使用習慣的網際網路功能。ASRock 主機板獨家配備 SmartView 公用程式，協助您隨時隨地與朋友保持聯繫。若要使用 SmartView 功能，請確定您所使用的作業系統版本為 Windows® 7 / 7 64 位元 / Vista™ / Vista™ 64 位元，而且您的瀏覽器版本是 IE8。
ASRock 網站：<http://www.asrock.com/Feature/SmartView/index.asp>
- 13、華擎 XFast USB 可提升 USB 儲存裝置的效能（效能可能須視裝置特性而定）。
- 14、華擎 XFast LAN 可提供更快的互聯網連接，包含以下諸多優勢。局域網優先應用：您可以設置理想的優先應用程式，並可以添加新程式。減少遊戲延遲：在設置優先級更高的網路遊戲時，可降低遊戲中的延遲。流量定形：您可以在觀看 Youtube 高解析影片的同時還進行文件下載。及時分析您的數據：透過狀態窗口，您可以清楚地看到目前正在傳輸的是哪個數據流。
- 15、華擎 XFast RAM 是 ASRock Extreme Tuning Utility (AXTU) 中加入的一項新功能。它能充分利用 Windows® 操作系統 32-bit CPU 無法使用的記憶體空間。華擎 XFast RAM 可縮短之前訪問過的網站的讀取時間，從而加快網路瀏覽速度。此外，它還能提升 Adobe Photoshop 執行的速度高達五倍之多。華擎 XFast RAM 的另一項優勢是它能減少使用 SSD 或 HDD 的頻率，從而延長它們的使用壽命。

- 16、華擎 Crashless BIOS 能讓使用者安心地更新他們的 BIOS，而不用擔心發生故障。如果在 BIOS 更新過程中斷電，華擎 Crashless BIOS 會在電源恢復後自動完成 BIOS 更新程序。請注意，BIOS 文件需存放在 USB 的根目錄中。此功能只支援 USB2.0 插槽。
- 17、系統管理員能夠透過 OMG 制定網際網路的限制使用時間，或限制只可在規定的時間存取網際網路。您可從 [每日]、[星期幾] 或 [工作日與週末] 中選擇，排程授予其他使用者進行網際網路存取的開始與結束時間。為防止使用者規避 OMG 的限制，必須新增無權更改系統時間的訪客帳號。
- 18、VIRTU Universal MVP 包括 Virtu 通用技術的基本功能，可虛擬化整合式 GPU 和獨立式 GPU，使 Breed 功能達到最佳效果。此外，它還採用 Virtual Vsync™ 技術，提供優良的視覺效果。利用 Hyperformance 技術所帶來的優勢，VIRTU Universal MVP 透過智慧地減少 CPU、GPU 和顯示器之間數據流的冗餘渲染任務，提高遊戲效能。
- 19、華擎 On/Off Play 技術可讓使用者享受攜帶式音訊裝置的絕妙音訊體驗，例如連接至 PC 的 MP3 播放機或手機，甚至在 PC 關機時（或在 ACPI S5 模式）也能享受！此主機板亦提供免費的 3.5mm 音訊線（選購），以確保使用者身處於最便利的運算環境內。
- 20、儘管本主機板提供無級頻率調控，但不推薦用戶超頻使用。不同於標準 CPU 側匯流排頻率的非標準頻率可能會使系統不穩定，甚至會損害 CPU 和主機板。
- 21、當檢測到 CPU 過熱問題時，系統會自動關機。在您重新啟動系統之前，請檢查主機板上的 CPU 風扇是否正常運轉並拔出電源線，然後再將它插回。為了提高散熱性，在安裝 PC 系統時請在 CPU 和散熱器之間塗一層散熱膏。
- 22、組合散熱片選項 (C.C.O.) 提供具有彈性的選項，讓您可以使用三種不同的 CPU 散熱片類型，分別是 LGA775、LGA1155 與 LGA1156。請注意：並非所有的 775 和 1156 CPU 風扇都支援此功能。
- 23、Microsoft® Windows® XP / XP 64-bit 系統不支援華擎 XFast RAM。Microsoft® Windows® Vista™ / Vista™ 64-bit / XP / XP 64-bit 系統不支援 Intel® 智能連接技術和 Intel® USB 3.0 接頭。
- 24、EuP, 全稱 Energy Using Product (能耗產品), 是歐盟用來定義完整系統耗電量的規定。根據 EuP 的規定，一個完整系統在關機模式下的交流電總消耗必須在 1.00W 以下。為符合 EuP 標準，您需要同時具備支援 EuP 的主機板和支援 EuP 的電源供應器。根據 Intel® 的建議，支援 EuP 的電源供應器必須符合在 100mA 電流消耗時，5Vsb 電源效率高於 50%。有關支援 EuP 的電源供應器選擇方面的詳情，我們建議您諮詢電源供應器的製造商。

1.3 跳線設置

插圖所示的就是設置跳線的方法。當跳線帽放置在針腳上時，這個跳線就是“短接”。如果針腳上沒有放置跳線帽，這個跳線就是“開路”。插圖顯示了一個3針腳的跳線，當跳線帽放置在針腳1和針腳2之間時就是“短接”。



接腳	設定		
清除 CMOS (CLRCMOS1, 3 針腳跳線) (見第 2 頁第 15 項)	<table border="0"><tr><td style="text-align: center;"> 1_2 默認設置</td><td style="text-align: center;"> 2_3 清除 CMOS</td></tr></table>	 1_2 默認設置	 2_3 清除 CMOS
 1_2 默認設置	 2_3 清除 CMOS		

註： CLRCMOS1 可供您清除 CMOS 中的資料。若要清除及重設系統參數並恢復為預設設定，請先關閉電腦電源，並從電源插座中拔下電源線，等待 15 秒鐘之後，使用跳線帽使 CLRCMOS1 的 pin2 及 pin3 短路 5 秒的時間。但請勿於更新 BIOS 後立即清除 CMOS。如需於更新 BIOS 後立即清除 CMOS，您必須先開機再關機，然後再執行 CMOS 清除操作。請注意，只有在移除 CMOS 電池的情況下，密碼、日期、時間、使用者預設設定檔、1394 GUID 及 MAC 位址才會清除。

1.4 接頭



此類接頭是不用跳線帽連接的，請不要用跳線帽短接這些接頭。
跳線帽不正確的放置將會導致主機板的永久性損壞！

Serial ATA2 接口

(SATA2_2_3: 見第 2 頁第 14 項)
(SATA2_4: 見第 2 頁第 21 項)
(SATA2_5: 見第 2 頁第 20 項)

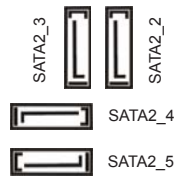

這裡有四組 Serial ATA2 (SATA2) 接口支援 SATA 數據線作為內部儲存設置。目前 SATA2 界面理論上可提供高達 3.0Gb/s 的數據傳輸速率。

Serial ATA3 接口

(SATA3_A0_A1: 見第 2 頁第 12 項)
(SATA3_0_1: 見第 2 頁第 13 項)

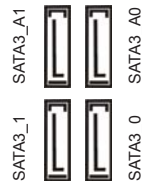

這裡有四組 Serial ATA3 (SATA3) 接口支援 SATA 數據線作為內部儲存設置。目前 SATA3 界面理論上可提供高達 6.0Gb/s 的數據傳輸速率。如果後面 I/O 上的 eSATA3 端口已連接，內部 SATA3_A1 將不起作用。

Serial ATA (SATA) 數據線

(選配)



SATA 數據線的任意一端均可連接 SATA/SATA2/SATA3 硬碟或者主機板上的 SATA2/SATA3 接口。

印表機接針

(25 針 LPT1)
(見第 2 頁第 28 項)

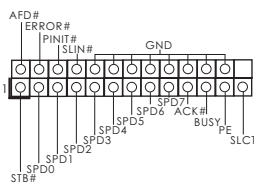

這是一個連接印表機的接口，方便您連接印表機設備。

USB 2.0 擴充接頭

(9 針 USB_6_7)

(見第 2 頁第 25 項)

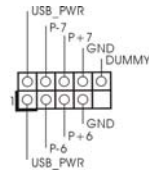

除了位於 I/O 面板的四個 USB 2.0 接口之外，這款主機板有三組 USB 2.0 接針。每組 USB 2.0 接針可以支援兩個 USB 2.0 接口。

(9 針 USB_8_9)

(見第 2 頁第 24 項)

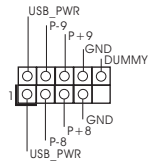

(9 針 USB_10_11)

(見第 2 頁第 23 項)

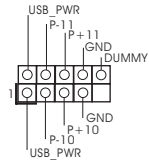

USB 3.0 擴充接頭

(19 針 USB3_12_13)

(見第 2 頁第 9 項)

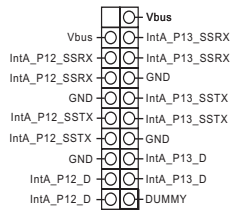

除了位於 I/O 面板的兩個 USB 3.0 接口之外，這款主機板有一組 USB 3.0 接針。這組 USB 3.0 接針可以支援兩個 USB 3.0 接口。

紅外線模組接頭

(5 針 IRI1)

(見第 2 頁第 19 項)

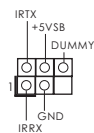

這個接頭支援一個選配的模組，可用來無線傳輸和接收紅外線。

消費性紅外線模組插座

(4 針 CIR1)

(見第 2 頁第 26 項)



此插座可用於連接遙控器。

前置音效接頭
(9 針 HD_AUDI01)
(見第 2 頁第 33 項)

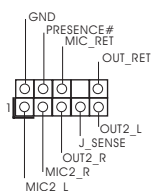

可以方便連接音效設備。



1. 高清晰音效 (High Definition Audio, HDA) 支援智能音效接口檢測功能 (Jack Sensing), 但是機箱面板的連線必須支持 HDA 才能正常使用。請按我們提供的手冊和機箱手冊上的使用說明安裝您的系統。
2. 如果您使用 AC' 97 音效面板, 請按照下面的步驟將它安裝到前面板音效接針:
 - A. 將 Mic_IN(MIC) 連接到 MIC2_L。
 - B. 將 Audio_R(RIN) 連接到 OUT2_R, 將 Audio_L(LIN) 連接到 OUT2_L。
 - C. 將 Ground(GND) 連接到 Ground(GND)。
 - D. MIC_RET 和 OUT_RET 僅用於 HD 音效面板。您不必將它們連接到 AC' 97 音效面板。
 - E. 開啟前置麥克風。
 在 Windows® XP / XP 64 位元作業系統中:
 選擇 "Mixer"。選擇 "Recorder"。接著點選 "FrontMic"。
 在 Windows® 7 / 7 64 位元 / Vista™ / Vista™ 64 位元作業系統中:
 在 Realtek 控制面板中點選 "FrontMic"。調整 "Recording Volume"。

系統面板接頭
(9 針 PANEL1)
(見第 2 頁第 18 項)

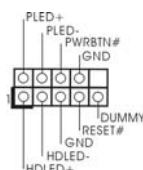

可接各種不同燈, 電源開關及重啟鍵等各種連線。



請根據下面的腳位說明連接機箱上的電源開關、重開按鈕與系統狀態指示燈到這個接頭。請先注意針腳的正負極。

- PWRBTN(電源開關):**
連接機箱前面板的電源開關。您可以設定用電源鍵關閉系統的方式。
- RESET(重開開關):**
連接機箱前面板的重開開關。當電腦當機且無法正常重新啟動時, 可按下重開開關重新啟動電腦。
- PLED(系統電源指示燈):**
連接機箱前面板的電源狀態指示燈。當系統運行時, 此指示燈亮起。當系統處於 S1/S3 待命模式時, 此指示燈保持閃爍。當系統處於 S4 待命模式或關機 (S5) 模式時, 此指示燈熄滅。
- HD LED(硬碟活動指示燈):**
連接機箱前面板的硬碟動作指示燈。當硬碟正在讀取或寫入數據時, 此指示燈亮起。

前面板設計因機箱不同而有差異。前面板模組一般由電源開關、重開開關、電源指示燈、硬碟活動指示燈、喇叭等構成。將您的機箱前面板連接到此接頭時，請確認連接線與針腳上的說明相對應。

機箱喇叭接頭
(4 針 SPEAKER1)
(見第 2 頁第 16 項)

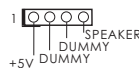

請將機箱喇叭連接到這個接頭。

電源指示燈接頭
(3 針 PLED1)
(見第 2 頁第 17 項)



請將機箱電源指示燈連接到此接頭，以指示系統電源狀態。當系統正在運行時，LED 指示燈亮。在 S1/S3 模式下，LED 指示燈會不停閃爍。在 S4 或 S5 模式（關機）下，LED 指示燈會熄滅。

機箱，電源風扇接頭
(4 針 CHA_FAN1)
(見第 2 頁第 22 項)

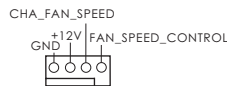

請將風扇連接線接到這個接頭，並讓黑線與接地的針腳相接。CHA_FAN1 和 CHA_FAN2 支援風扇控制。

(3 針 CHA_FAN2)
(見第 2 頁第 35 項)

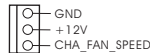

(3 針 PWR_FAN1)
(見第 2 頁第 2 項)

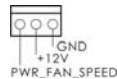

CPU 風扇接頭
(4 針 CPU_FAN1)
(見第 2 頁第 3 項)

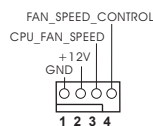

請將 CPU 風扇連接線接到這個接頭，並讓黑線與接地的針腳相接。



雖然此主板支持 4-Pin CPU 風扇 (Quiet Fan, 靜音風扇)，但是沒有調速功能的 3-Pin CPU 風扇仍然可以在此主板上正常運行。如果您打算將 3-Pin CPU 風扇連接到此主板的 CPU 風扇接口，請將它連接到 Pin 1-3。

Pin 1-3 連接
3-Pin 風扇的安裝



(3 針 CPU_FAN2)
(見第 2 頁第 1 項)

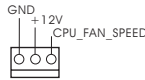

ATX 電源接頭
(24 針 ATXPWR1)
(見第 2 頁第 8 項)

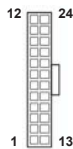

請將 ATX 電源供應器連接到這個接頭。



雖然此主機板提供 24-pin ATX 電源接口，但是您仍然可以使用傳統的 20-pin ATX 電源。為了使用 20-pin ATX 電源，請順著 Pin 1 和 Pin 13 插上電源接頭。

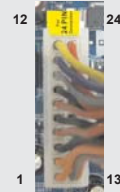

20-Pin ATX 電源安裝說明

ATX 12V 電源接口
(8 針 ATX12V1)
(見第 2 頁第 4 項)



請將 ATX 12V 電源供應器連接到這個接頭。



雖然此主機板提供 8-pin ATX 12V 電源接口，但是您仍然可以使用傳統的 4-pin ATX 12V 電源。為了使用 4-pin ATX 12V 電源，請順著 Pin 1 和 Pin 5 插上電源接頭。



4-Pin ATX 12V 電源安裝說明

序列埠
(9 針 COM1)
(見第 2 頁第 27 項)

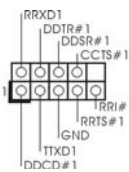

這個序列埠 COM1 支援一個序列埠的裝置。

HDMI_SPDIF 接頭
(2 針 HDMI_SPDIF1)
(見第 2 頁第 34 項)



HDMI_SPDIF 接頭，提供 SPDIF 音效輸出至 HDMI 顯示卡，支援將電腦連接至帶 HDMI 的數位電視 / 投影機 / 液晶銀幕等設備。請將 HDMI 顯示卡的 HDMI_SPDIF 接口連接到這個接頭。

2. BIOS 訊息

主板上的 Flash Memory 晶片存儲了 BIOS 設置程序。啟動系統，在系統開機自檢 (POST) 的過程中按下 <F2> 或 鍵，就可進入 BIOS 設置程序，否則將繼續進行開機自檢之常規檢驗。如果需要在開機自檢後進入 BIOS 設置程序，請按下 <Ctl> + <Alt> + <Delete> 鍵重新啟動電腦，或者按下系統面板上的重開按鈕。功能設置程序儲存有主板自身的和連接在其上的設備的缺省和設定的參數。這些訊息用於在啟動系統和系統運行需要時，測試和初始化元件。有關 BIOS 設置的詳細訊息，請查閱隨機支援光碟裡的使用手冊 (PDF 文件)。

3. 支援光碟訊息

本主板支援各種微軟 Windows[®] 操作系統：Microsoft[®] Windows[®] 7/7 64 位元 / Vista[™]/Vista[™] 64 位元 /XP/XP 64 位元。主板附帶的支援光碟包含各種有助於提高主板效能的必要驅動和實用程式。請將隨機支援光碟放入光碟機裡，如果系統的“自動運行”功能已啟用，銀幕將會自動顯示主菜單。如果主菜單不能自動顯示，請查閱支援光碟內 BIN 文件夾下的 ASSETUP.EXE 文件並雙點它，即可調出主菜單。

1. Penjelasan

Terima kasih telah membeli motherboard ASRock **Z77 Pro4-M**, motherboard andal yang diproduksi berdasarkan kontrol kualitas tinggi ASRock secara konsisten.

Motherboard ini memberikan performa terbaik dengan desain yang kokoh sesuai komitmen ASRock untuk kualitas dan daya tahan.

Panduan Pemasangan Ringkas ini berisi pendahuluan tentang motherboard dan panduan pemasangan langkah demi langkah. Informasi lengkap lainnya tentang motherboard ini tersedia di buku panduan yang diberikan bersama Support CD (CD Pendukung).



Karena spesifikasi papan induk dan software BIOS barangkali dapat diperbarui, isi dalam buku pedoman ini akan mengikuti perubahan tanpa peringatan. Dalam kondisi terjadinya modifikasi buku pedoman ini, versi baru akan diperlihatkan dalam website ASRock tanpa peringatan lebih. Anda dapat mendapatkan kartu- kartu yang paling baru dan daftar bantuan CPU pada website ASRock.
Website ASRock <http://www.asrock.com>

1.1 Isi Paket

Papan Induk **Z77 Pro4-M** ASRock

(Faktor Form Mikro ATX: 9.6-in x 9.6-in, 24.4 cm x 24.4 cm)

Pemimpin Instalasi Cepat **Z77 Pro4-M** ASRock

Support CD **Z77 Pro4-M** ASRock

2 x Kabel satu serial Data ATA (SATA) (bebas-pilih)

1 x Satu Pelindung I/O



ASRock Mengingatkan...

Untuk mendapatkan performa lebih baik di Windows® 7/ 7 64-bit/ Vista™/ Vista™ 64-bit, sebaiknya atur pilihan BIOS dalam Storage Configuration (Konfigurasi Penyimpanan) ke mode AHCI. Untuk konfigurasi BIOS, lihat "Panduan Pengguna" dalam CD dukungan kami untuk informasi rinci.

1.2 Spesifikasi

Podium	<ul style="list-style-type: none"> - Faktor Form Mikro ATX: 9.6-in x 9.6-in, 24.4 cm x 24.4 cm - Desain All Solid Capacitor (100% Kapasitor Polimer Konduktif buatan Jepang berkualitas tinggi)
CPU	<ul style="list-style-type: none"> - Mendukung Intel® Core™ i7 / i5 / i3 Generasi Ke-3 dan Ke-2 dalam Paket LGA1155 - Digi Power Desain - Desain daya 4+2 fase - Menggunakan Teknologi Intel® Turbo Boost 2.0 - Mendukung CPU K-Series jenis “unlocked” - Menggunakan Teknologi Hyper-Threading - Mendukung Intel® Rapid Start Technology dan Smart Connect Technology dengan Intel® Ivy Bridge CPU
Grup Chip	<ul style="list-style-type: none"> - Intel® Z77
Ingatan	<ul style="list-style-type: none"> - Teknologi ingatan DDR3 dwisaluran - 4 x Alur DDR3 DIMM - Mendukung memori DDR3 2800+(OC)/2400(OC)/2133(OC) /1866(OC)/1600/1333/1066 non-ECC yang tidak di-buffer - Kapasitas paling banyak: 32GB - Mendukung Intel® Extreme Memory Profile (XMP)1.3/1.2
Alur Ekspansi	<ul style="list-style-type: none"> - 1 x PCI Express 3.0 x16 slots (PCIe1: x16 mode) * PCIe 3.0 hanya didukung dengan Intel® Ivy Bridge CPU. Dengan Intel® Sandy Bridge CPU, hanya PCIe 2.0 yang didukung. - 2 x PCI Express 2.0 x16 slot (PCIe3: x1 mode; PCIe4: x4 mode) - 1 x PCI Express 2.0 x1 slot - Mendukung AMD Quad CrossFireX™ dan CrossFireX™
Diagram	<ul style="list-style-type: none"> * Intel® HD Graphics Built-in Visual dan output VGA hanya dapat didukung dengan prosesor yang mengintegrasikan GPU. - Mendukung Intel® HD Graphics Built-in Visuals: Intel® Quick Sync Video 2.0, Intel® InTru™ 3D, Intel® Clear Video HD Technology, Intel® Insider™, Intel® HD Graphics 2500/4000 - Pixel Shader 5.0, DirectX 11 dengan Intel® Ivy Bridge CPU, Pixel Shader 4.1, DirectX 10.1 dengan Intel® Sandy Bridge CPU - Ingatan sama Max. 1760MB - Tiga pilihan VGA Output: D-Sub, DVI-D dan HDMI - Mendukung HDMI 1.4a Technology dengan resolusi

	<p>maksimal hingga 1920x1200 @ 60Hz</p> <ul style="list-style-type: none"> - Mendukung DVI dengan resolusi maksimal hingga 1920x1200 @ 60Hz - Mendukung D-Sub dengan resolusi maksimal hingga 2048x1536 @ 75Hz - Mendukung Auto Lip Sync, Deep Color (12bpc), xvYCC dan HBR (High Bit Rate Audio) dengan HDMI (memerlukan monitor HDMI yang kompatibel) - Mendukung fungsi HDCP dengan port DVI dan HDMI - Mendukung pemutaran 1080p Blu-ray (BD) / HD-DVD dengan port DVI dan HDMI
Audio	<ul style="list-style-type: none"> - 7.1 CH HD Audio dengan Content Protection (Realtek ALC892 Audio Codec) - Menggunakan Premium Blu-ray audio - Menggunakan THX TruStudio™
LAN	<ul style="list-style-type: none"> - PCIE x1 Gigabit LAN 10/100/1000 Mb/s - Realtek RTL8111E - Menggunakan Wake-On-LAN - Mendukung Deteksi Kabel LAN - Mendukung Energy Efficient Ethernet 802.3az - Mendukung PXE
Papan Belakang I/O	<p>I/O Panel</p> <ul style="list-style-type: none"> - 1 x Port Keyboard PS/2 - 1 x Port D-Sub - 1 x Port DVI-D - 1 x Port HDMI - 1 x Port Keluaran Optical SPDIF - 4 x Port USB 2.0 siap-dipakai - 1 x Port eSATA3 - 2 x Port USB 3.0 siap-dipakai - 1 x RJ-45 LAN Port LED (ACT/LINK LED dan SPEED LED) - HD Audio Jack: Penyuar Belakang/Pusat/Bass/Line in/ Penyuar Depan/mikropon
SATA3	<ul style="list-style-type: none"> - 2 x penghubung Intel® Z77 SATA3 6.0Gb/s, dapat digunakan RAID (RAID 0, RAID 1, RAID 5, RAID 10, Intel Rapid Storage dan Intel Smart Response Technology), NCQ, AHCI dan fungsi fungsi Hot Plug - 2 x penghubung ASMedia ASM1061 SATA3 6.0Gb/s, dapat digunakan NCQ, AHCI dan fungsi fungsi "Hot Plug" (konektor SATA3_A1 dibagi dengan port eSATA3)

USB 3.0	<ul style="list-style-type: none"> - 2 x Port Belakang USB 3.0, mendukung USB 1.0/2.0/3.0 hingga 5Gb/s - 1 x Port Depan USB 3.0 (menggunakan 2 port USB 3.0), mendukung USB 1.0/2.0/3.0 hingga 5Gb/s
Penghubung	<ul style="list-style-type: none"> - 4 x penghubung SATA2 3.0Gb/s, dapat menggunakan RAID (RAID 0, RAID 1, RAID 5, RAID 10, Intel Rapid Storage dan Intel Smart Response Technology), NCQ, AHCI dan fungsi Hot Plug - 4 x penghubung SATA3 6.0Gb/s - 1 x IR header - 1 x CIR header - 1 x port header Print - 1 x port header COM - 1 x HDMI_SPDIF header - 1 x header power LED - Penghubung KIPAS CPU/casis/power - Penghubung power 24 pin ATX - Penghubung power 8 pin 12V - Penghubung audio panel dapan - 3 x USB 2.0 header (menggunakan 6 port USB 2.0) - 1 x USB 3.0 header (menggunakan 2 port USB 3.0)
Ciri-ciri BIOS	<ul style="list-style-type: none"> - 64Mb AMI UEFI Legal BIOS dengan dukungan GUI - Menggunakan "Plug and Play" - ACPI 1.1 Compliance Wake Up Events - Menggunakan jumperfree - Penyokong AMBIOS 2.3.1 - Penyesuaian berbagai tegangan CPU Core, IGPU, DRAM, 1.8V PLL, VTT, VCCSA
Sokongan CD	<ul style="list-style-type: none"> - Driver, Utilitas, Perangkat Lunak Antivirus (Versi Percobaan), CyberLink MediaEspresso 6.5 Versi Percobaan, ASRock MAGIX Multimedia Suite - OEM
Fitur Unik	<ul style="list-style-type: none"> - ASRock Extreme Tuning Utility (AXTU) - ASRock Instant Boot - ASRock Instant Flash - ASRock APP Charger - ASRock SmartView - ASRock XFast USB - ASRock XFast LAN - ASRock XFast RAM - ASRock Crashless BIOS - ASRock OMG (Online Management Guard)

	<ul style="list-style-type: none"> - Lucid Virtu Universal MVP * Lucid Virtu Universal MVP hanya dapat didukung dengan prosesor yang mengintegrasikan GPU. - ASRock On/Off Play Technology - Hybrid Booster: <ul style="list-style-type: none"> - Kontrol tanpa langkah Frekwensi CPU - ASRock U-COP - Penjaga kegagalan input (B.F.G.) - Combo Cooler Option (C.C.O.) - Good Night LED
Penjaga Hardware	<ul style="list-style-type: none"> - Perasa Suhu CPU - Perasa Suhu Casis - Pengukur Kipas CPU/casis/power - Kipas CPU/Sasis Senyap (Kecepatan Kipas Sasis Otomatis Disesuaikan Berdasarkan Temperatur CPU) - Kontrol Multi-Kecepatan Kipas CPU/casis - Penjagaan voltasi: +12V, +5V, +3.3V, Vcore
OS	<ul style="list-style-type: none"> - dapat digunakan Microsoft® Windows® 7 / 7 64-bit / Vista™ / Vista™ 64-bit / XP / XP 64-bit
Sertifikasi	<ul style="list-style-type: none"> - FCC, CE, WHQL - ErP/EuP Ready (memerlukan catu daya ErP/EuP ready)

* Untuk informasi rinci, silakan kunjungi website kami: <http://www.asrock.com>

Installing OS on a HDD Larger Than 2TB

This motherboard adopts UEFI BIOS that allows Windows® OS to be installed on a large size HDD (>2TB). Please follow the procedures below to install the operating system.

1. Please make sure to use **Windows® Vista™ 64-bit (with SP2 or above)** or **Windows® 7 64-bit (with SP1 or above)**.
2. Press <F2> or <Delete> at system POST. Set **AHCI Mode** in UEFI Setup Utility > Advanced > Storage Configuration > SATA Mode.
3. Choose the item "**UEFI:xxx**" to boot in UEFI Setup Utility > Boot > Boot Option #1. ("xxx" is the device which contains your Windows® installation files. Normally it is an optical drive.) You can also press <F11> to launch boot menu at system POST and choose the item "**UEFI:xxx**" to boot.
4. Start Windows® installation.

Installing OS on a HDD Larger Than 2TB in RAID Mode

This motherboard adopts UEFI BIOS that allows Windows® OS to be installed on a large size HDD (>2TB). Please follow the procedures below to install the operating system.

1. Please make sure to use **Windows® Vista™ 64-bit (with SP2 or above)** or **Windows® 7 64-bit (with SP1 or above)**.
2. Copy Intel® RAID drivers into a USB flash disk. You can download the driver from ASRock's website and unzip the file into a USB flash disk **OR** copy the file from ASRock motherboard support CD. (please copy the files under the following directory:
32 bit: ..\i386\Win7_Vista_Intel_v11.0.0.1032
64-bit: ..\AMD64\Win7-64_Vista64_Intel_v11.0.0.1032
3. Create a RAID array for you system. Please refer to "Intel RAID Installation Guide" file for details.
4. Install Windows® Vista™ 64-bit / 7 64-bit:
 - A. Insert your Windows® Vista™ 64-bit / 7 64-bit installation disc to the optical drive.
 - B. Press <F11> to launch boot menu at system POST and choose the item "UEFI:xxx" to boot.
 - C. Start Windows® Installation. When you see "Where do you want to install Windows?" page, please click "Load Driver".



- D. Plug the USB flash disk into your USB port; select "Browse" to find the RAID driver. Then choose the directory (xx\AMD64\) you have copied in the first step.

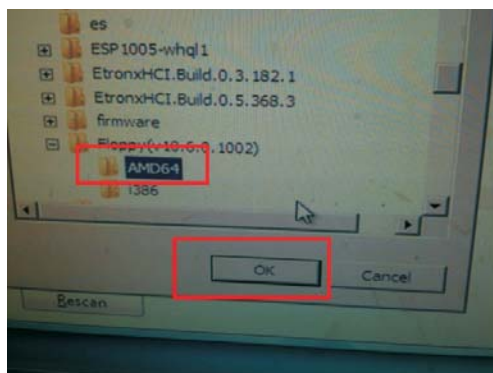

- E. Please keep the USB flash disk installed until the system first reboot.
F. Continue to install OS by following the Windows® instructions.
5. Follow Windows® Installation Guide to install OS.

If you install Windows® 7 64-bit / Vista™ 64-bit in a large hard disk (ex. Disk volume > 2TB), it may take more time to boot into Windows® or install driver/utilities. If you encounter this problem, you will need to following instructions to fix this problem.

Windows® Vista™ 64-bit:

Microsoft® does not provide hotfix for this problem. The steps listed below are Microsoft®'s suggested solution:

A. Disable System Restore.

- a. Type "systempropertiesprotection" in the Start Menu. Then press "Enter".



- b. De-select Local Disks for System Restore. Then Click "Turn System Restore Off" to confirm. Then Press "Ok".

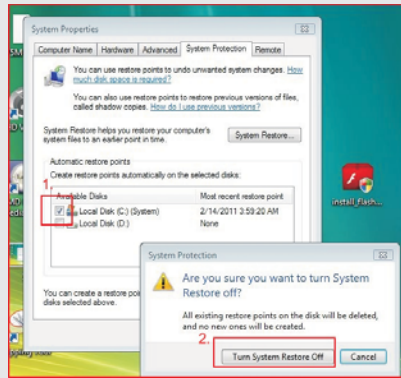

B. Disable "Volume Shadow Copy" service.

a. Type "computer management" in the Start Menu, then press "Enter".

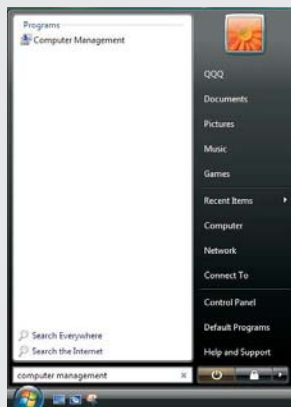

b. Go to "Services and Applications>Services"; Then double click "Volume Shadow Copy".

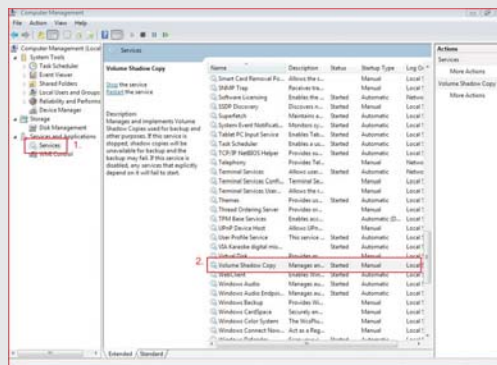

English

c. Set "Startup type" to "Disable" then Click "OK".

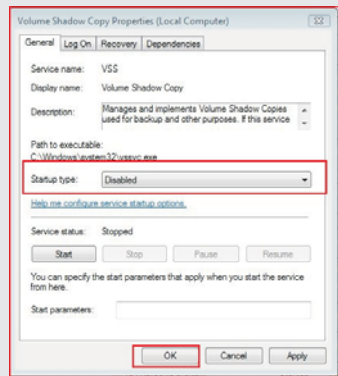

C. Reboot your system.

D. After reboot, please start to install motherboard drivers and utilities.

Windows® 7 64-bit:

A. Please request the hotfix KB2505454 through this link:

<http://support.microsoft.com/kb/2505454/>

B. After installing Windows® 7 64-bit, install the hotfix kb2505454.

(This may take a long time; >30 mins.)

C. Reboot your system. (It may take about 5 minutes to reboot.)

D. Windows® will install this hotfix then reboot by itself.

E. Please start to install motherboard drivers and utilities.

6. Finish.