



When you installing AGP card, please make sure the following notice is fully understood and practiced. If your AGP card has "AGP 4X/8X(1.5V) notch"(show below), please make sure your AGP card is AGP 4X/8X(1.5V).



Caution: AGP 2X(3.3V) card is not supported by VIA® KT400. You might experience system unable to boot up normally. Please insert an AGP 4X/8X(1.5V) card

Example 1: Diamond Vipper V770 golden finger is compatible with 2X/4X mode AGP slot. It can be switched between AGP 2X(3.3V) or 4X(1.5V) mode by adjusting the jumper. The factory default for this card is 2X(3.3V).

The GA-7VAX / GA-7VAX1394 / GA-7VAXP / GA-7VAXP Ultra (or any AGP 4X only) motherboards might not function properly, if you install this card without switching the jumper to 4X(1.5) mode in it.

Example 2: Some ATi Rage 128 Pro graphics cards made by "Power Color", the graphics card manufacturer & some SiS 305 cards, their golden finger is compatible with 2X(3.3V)/4X(1.5V) mode AGP slot, but they support 2X(3.3V) only. The GA-7VAX / GA-7VAX1394 / GA-7VAXP / GA-7VAXP Ultra (or any AGP 4X only) motherboards might not function properly, if you install this card in it.

Note : Although Gigabyte's AG32S(G) graphics card is based on ATi Rage 128 Pro chip, the design of AG32S(G) is compliance with AGP 4X(1.5V) specification. Therefore, AG32S (G) will work fine with VIA® KT400 based motherboards.



Before you install PCI cards, please remove the Dual BIOS label from PCI slots if there is one.



- ⚠ The author assumes no responsibility for any errors or omissions that may appear in this document nor does the author make a commitment to update the information contained herein.
- ⚠ Third-party brands and names are the property of their respective owners.
- ⚠ Please do not remove any labels on motherboard, this may void the warranty of this motherboard.
- ⚠ Due to rapid change in technology, some of the specifications might be out of date before publication of this booklet.



WARNING: Never run the processor without the heatink properly and firmly attached. PERMANENT DAMAGE WILL RESULT!

Mise en garde : Ne faites jamais tourner le processeur sans que le dissipateur de chaleur soit fixé correctement et fermement. UN DOMMAGE PERMANENT EN RÉSULTERA !

Achtung: Der Prozessor darf nur in Betrieb genommen werden, wenn der Wärmeableiter ordnungsgemäß und fest angebracht ist. DIES HAT EINEN PERMANENTEN SCHADEN ZUR FOLGE!

Advertencia: Nunca haga funcionar el procesador sin el dissipador de calor instalado correctamente y firmemente. SE PRODUCIRÁ UN DAÑO PERMANENTE!

Aviso: Nunca execute o procesador sem o dissipador de calor estar adequado e firmemente conectado. O RESULTADO SERÁ UM DANO PERMANENTE!

警告: 將處理器牢固地安裝到處理器上之前，不要運行處理器。否則將永遠損壞處理器！

警告: 將處理器牢固地安裝到處理器上之前，不要運行處理器。否則將永遠損壞處理器！

경고: 미드얼트를 제대로 조여지지 않을 때까지 또는 프로세서를 다루지 않을 때까지도 영구적 손상이 발생할 수 있습니다!

警告: 永久的な損傷を防ぐため、ヒートシンクを正しくしっかりと取り付けるまでは、プロセッサを動作させないようにしてください。

Declaration of Conformity

We, Manufacturer/Importer
(full address)

G.B.T. Technology Trading GmbH
Ausschlagweg 41, 1F, 20537 Hamburg, Germany

declare that the product
(description of the apparatus, system, installation to which it refers)

Mother Board

GA-7VAX / GA-7VAX1394 / GA-7VAXP / GA-7VAXP Ultra
is in conformity with

(reference to the specification under which conformity is declared)
in accordance with 89/336 EEC-EMC Directive

| | | | |
|--|--|--|--|
| <input type="checkbox"/> EN 55011 | Limits and methods of measurement of radio disturbance characteristics of industrial, scientific and medical (ISM) high frequency equipment | <input type="checkbox"/> EN 61000-3-2* <input checked="" type="checkbox"/> EN 60555-2 | Disturbances in supply systems cause by household appliances and similar electrical equipment "Harmonics" |
| <input type="checkbox"/> EN 55013 | Limits and methods of measurement of radio disturbance characteristics of broadcast receivers and associated equipment | <input type="checkbox"/> EN 61000-3-3* <input checked="" type="checkbox"/> EN 60555-3 | Disturbances in supply systems cause by household appliances and similar electrical equipment "Voltage fluctuations" |
| <input type="checkbox"/> EN 55014 | Limits and methods of measurement of radio disturbance characteristics of household electrical appliances, portable tools and similar electrical apparatus | <input checked="" type="checkbox"/> EN 50081-1 <input checked="" type="checkbox"/> EN 50082-1 | Generic emission standard Part 1: Residual commercial and light industry Generic immunity standard Part 1: Residual commercial and light industry |
| <input type="checkbox"/> EN 55015 | Limits and methods of measurement of radio disturbance characteristics of fluorescent lamps and luminaries | <input type="checkbox"/> EN 55081-2 | Generic emission standard Part 2: Industrial environment |
| <input type="checkbox"/> EN 55020 | Immunity from radio interference of broadcast receivers and associated equipment | <input type="checkbox"/> EN 55082-2 | Generic emission standard Part 2: Industrial environment |
| <input checked="" type="checkbox"/> EN 55022 | Limits and methods of measurement of radio disturbance characteristics of information technology equipment | <input type="checkbox"/> ENV 55104 | Immunity requirements for household appliances tools and similar apparatus |
| <input type="checkbox"/> DIN VDE 0 855 <input type="checkbox"/> part 10 <input type="checkbox"/> part 12 | Cabled distribution systems; Equipment for receiving and/or distribution from sound and television signals | <input type="checkbox"/> EN 50091-2 | EMC requirements for uninterruptible power systems (UPS) |
| <input checked="" type="checkbox"/> CE marking | |  | (EC conformity marking) |

The manufacturer also declares the conformity of above mentioned product
with the actual required safety standards in accordance with LVD 73/23 EEC

| | | | |
|-----------------------------------|---|-------------------------------------|---|
| <input type="checkbox"/> EN 60065 | Safety requirements for mains operated electronic and related apparatus for household and similar general use | <input type="checkbox"/> EN 60950 | Safety for information technology equipment including electrical business equipment |
| <input type="checkbox"/> EN 60335 | Safety of household and similar electrical appliances | <input type="checkbox"/> EN 50091-1 | General and Safety requirements for uninterruptible power systems (UPS) |

Manufacturer/Importer

Date : December 27, 2002

Signature:

Name:

Timmy Huang
Timmy Huang

DECLARATION OF CONFORMITY

Per FCC Part 2 Section 2.1077(a)



Responsible PartName: G.B.T. INC. (U.S.A.)

Address: 17358 Railroad Street
City of Industry, CA 91748

Phone/FaxNo: (818) 854-9338/ (818) 854-9339

hereby declares that the product

Product Name: Motherboard

Model Number: GA-7VAX/GA-7VAX1394
GA-7VAXP/GA-7VAXP Ultra

Conforms to the following specifications:

FCC Part 15, Subpart B, Section 15.107(a) and Section 15.109
(a), Class B Digital Device

Supplementary Information:

This device complies with part 15 of the FCC Rules. Operation is subject to the following two conditions: (1) This device may not cause harmful and (2) this device must accept any interference received, including that may cause undesired operation.

Representative Person's Name: ERIC LU

Signature: Eric Lu

Date: December27,2002

GIGABYTE obtained of the event to validate the performance of ATi and Nvidia based graphics cards (AGP 8X) with VIA Chipset based motherboards running Microsoft operating systems. Certificates of Validation will be supplied by VIA, ATi and nVIDIA for GA-7VAXP Ultra; GA-7VAXP; GA-7VAX1394; GA-7VAX and GA-7VA that successfully passed in the AGP 8X standard validation



KT400 Series
AMD Socket A Processor Motherboard

USER'S MANUAL

AMD Athlon™/Athlon™ XP/Duron™ SocketA Processor Motherboard

Rev. 1202

12ME-7VAXPU-1202

Table of Content

| | |
|--|----|
| Item Checklist | 4 |
| WARNING! | 4 |
| Chapter 1 Introduction | 5 |
| Features Summary | 5 |
| KT400 Series Motherboard Layout | 8 |
| Chapter 2 Hardware Installation Process | 9 |
| Step 1: Install the Central Processing Unit (CPU) | 10 |
| Step1-1: CPU Speed Setup | 10 |
| Step1-2: CPU Installation | 11 |
| Step1-3: CPU Heat Sink Installation | 12 |
| Step 2: Install memory modules | 13 |
| Step 3: Install expansion cards | 14 |
| Step 4: Connect ribbon cables, cabinet wires, and power supply | 15 |
| Step4-1 : I/O Back Panel Introduction | 15 |
| Step4-2 : Connectors Introduction | 17 |
| Chapter 3 BIOS Setup | 25 |
| The Main Menu (For example: BIOS Ver. : F8) | 26 |
| Standard CMOS Features | 28 |
| Advanced BIOS Features | 31 |
| Integrated Peripherals | 33 |
| Power Management Setup | 38 |
| PnP/PCI Configurations | 41 |
| PC Health Status | 42 |

| | |
|---|----|
| Frequency/Voltage Control | 44 |
| Top Performance | 47 |
| Load Fail-Safe Defaults | 48 |
| Load Optimized Defaults | 49 |
| Set Supervisor/User Password | 50 |
| Save & Exit Setup | 51 |
| Exit Without Saving | 52 |
| | |
| Chapter 4 Technical Reference | 55 |
| Block Diagram | 55 |
| Dual BIOS / Q-Flash Introduction | 67 |
| @ BIOS Introduction | 76 |
| Easy Tune™ 4 Introduction | 77 |
| 2-/4-/6-Channel Audio Function Introduction | 78 |
| | |
| Chapter 5 Appendix | 85 |

Item Checklist

- | | |
|---|---|
| <input checked="" type="checkbox"/> The KT400 Series motherboard | <input checked="" type="checkbox"/> RAID Manual ** |
| <input checked="" type="checkbox"/> IDE cable x 1/ Floppy cable x 1 | <input checked="" type="checkbox"/> 4 Port USB Cable x 1 |
| <input checked="" type="checkbox"/> IDE cable x 2 ** | <input checked="" type="checkbox"/> Audio combo Kit x1 ** |
| <input checked="" type="checkbox"/> CD for motherboard driver & utility | <input checked="" type="checkbox"/> IEEE 1394 Cable x1 *** |
| <input checked="" type="checkbox"/> KT400 Series user's manual | <input type="checkbox"/> SPD Kit x1 |
| <input checked="" type="checkbox"/> I/O Shield | <input checked="" type="checkbox"/> Quick PC Installation Guide |
| <input checked="" type="checkbox"/> Motherboard Settings Label | <input checked="" type="checkbox"/> SATA RAID Manual * |
| <input checked="" type="checkbox"/> SATA cable x 2 * | <input type="checkbox"/> GC-SATA Card * (Optional) |
- (Manual ; SATA cable x1 ; Power cable x1)



WARNING!

Computer motherboards and expansion cards contain very delicate Integrated Circuit (IC) chips. To protect them against damage from static electricity, you should follow some precautions whenever you work on your computer.

1. Unplug your computer when working on the inside.
2. Use a grounded wrist strap before handling computer components. If you do not have one, touch both of your hands to a safely grounded object or to a metal object, such as the power supply case.
3. Hold components by the edges and try not to touch the IC chips, leads or connectors, or other components.
4. Place components on a grounded antistatic pad or on the bag that came with the components whenever the components are separated from the system.
5. Ensure that the ATX power supply is switched off before you plug in or remove the ATX power connector on the motherboard.

Installing the motherboard to the chassis...

If the motherboard has mounting holes, but they don't line up with the holes on the base and there are no slots to attach the spacers, do not become alarmed you can still attach the spacers to the mounting holes. Just cut the bottom portion of the spacers (the spacer may be a little hard to cut off, so be careful of your hands). In this way you can still attach the motherboard to the base without worrying about short circuits. Sometimes you may need to use the plastic springs to isolate the screw from the motherboard PCB surface, because the circuit wire may be near by the hole. Be careful, don't let the screw contact any printed circuit wire or parts on the PCB that are near the fixing hole, otherwise it may damage the board or cause board malfunctioning.

** * FOR GA-7VAXP Ultra Only.

** * FOR GA-7VAXP Ultra / GA-7VAXP Only.

** * * For GA-7VAXP Ultra / GA-7VAXP / GA-7VAX1394 Only.

Chapter 1 Introduction

Features Summary

| | |
|----------------------|--|
| Form Factor | <ul style="list-style-type: none"> 30.5cm x 24.3cm ATX size form factor, 4 layers PCB. |
| Motherboard | <ul style="list-style-type: none"> KT400 Series: GA-7VAX / GA-7VAX1394 / GA-7VAXP / GA-7VAXP Ultra |
| CPU | <ul style="list-style-type: none"> Socket A processor AMD Athlon™/Athlon™ XP/ Duron™ (K7) 128K L1 & 256K/64K L2 cache on die 200/266/333^{<Note 1>} MHz FSB and DDR bus speeds Supports 1.4GHz and faster |
| Chipset | <ul style="list-style-type: none"> VIA KT400 Memory/AGP/PCI Controller (PAC) VIA VT8235 Integrated Peripheral Controller (PSIPC) |
| Memory | <ul style="list-style-type: none"> 3 184-pin DDR sockets Supports DDR DRAM PC1600/PC2100/PC2700/PC3200^{<Note 2>} Supports up to 3.0GB DDR (Max) Supports only 2.5V DDR DIMM |
| I/O Control | <ul style="list-style-type: none"> IT8705 |
| Slots | <ul style="list-style-type: none"> 1 AGP slot supports 8X/4X/2X mode (1.5V) & AGP 3.0 Compliant 5 PCI slots supports 33MHz & PCI 2.2 compliant |
| On-Board IDE | <ul style="list-style-type: none"> 2 IDE controllers provides IDE HDD/CD-ROM (IDE1, IDE2) with PIO, Bus Master (Ultra DMA33/ATA66/ATA100/ATA133) operation modes. IDE3 and IDE4 Compatible with RAID, Ultra ATA133/100, EIDE ** |
| On-Board Peripherals | <ul style="list-style-type: none"> 1 Floppy port supports 2 FDD with 360K, 720K, 1.2M, 1.44M and 2.88M bytes. 1 Parallel port supports Normal/EPP/ECP mode 2 Serial port (COMA & COMB) 6 x USB 2.0/1.1 (4 by cable) 3 x IEEE1394 by cable *** 1 IrDA connector for IR 1 Smart Card Reader connector for SCR |
| Hardware Monitor | <ul style="list-style-type: none"> CPU/System Fan Revolution detect CPU/System temperature detect System Voltage Detect Thermal shutdown function |

<Note 1> FSB333 MHz only support DDR333 DIMM module.

<Note 2> PC3200 only support by Micro, Samsung, Apacer DDR module as we verified, more detail pls refer to P.99 to be continued.....

" *** " For GA-7VAXP Ultra / GA-7VAXP / GA-7VAX1394 Only.

| | |
|-----------------------|--|
| On-Board Sound | <ul style="list-style-type: none"> • Realtek ALC650 CODEC • Line Out/ 2 front speaker • Line In / 2 rear speaker (by s/w switch) • Mic In / center & subwoofer (by s/w switch) • SPDIF Out / SPDIF In • CD In / AUX In / Game port |
| On-Board USB 2.0 | <ul style="list-style-type: none"> • Built in VIA VT8235 Chipset |
| On-Board RAID ** | <ul style="list-style-type: none"> • Onboard Promise PDC20276 • Supports data striping (RAID 0) or mirroring (RAID 1) • Supports concurrent dual IDE controller operation • Supports IDE bus master operation • Displays status and error checking messages during boot-up • Mirroring supports automatic background rebuilds • Features LBA and Extended Interrupt 13 drive translation in controller onboard BIOS |
| On-Board SATA RAID * | <ul style="list-style-type: none"> • Onboard Silicon Image SiI3112A • Supports Disk striping (RAID0) or DISK Mirroring (RAID1) • Supports UDMA up to 150 MB/sec • All UDMA and PIO Modes • Up to 2 SATA Device • ACPI and ATA/ATAPI6 |
| On-Board LAN | <ul style="list-style-type: none"> • Realtek RTL8100BL |
| On-Board IEEE1394 *** | <ul style="list-style-type: none"> • VT6306 |
| PS/2 Connector | <ul style="list-style-type: none"> • PS/2 Keyboard interface and PS/2 Mouse interface |
| BIOS | <ul style="list-style-type: none"> • Licensed Award BIOS, 2M bit flash ROM • Supports Dual BIOS / Q-Flash |
| Additional Features | <ul style="list-style-type: none"> • PS/2 Keyboard power on by password, PS/2 Mouse power on • External Modem wake up • STR (Suspend-To-RAM) • Wake on LAN (WOL) • AC Recovery • Polyfuse for keyboard over-current protection • USB KB/Mouse wake up from S3 • Supports @BIOS • Supports EasyTune 4 |
| Overclocking | <ul style="list-style-type: none"> • Over Voltage (DDR/AGP/CPU) by BIOS • Over Clock (DDR/AGP/CPU/PCI) by BIOS |

" * " FOR GA-7VAXP Ultra Only.

" ** " FOR GA-7VAXP Ultra / GA-7VAXP Only.

" *** " For GA-7VAXP Ultra / GA-7VAXP / GA-7VAX1394 Only.



Please set the CPU host frequency in accordance with your processor's specifications. We don't recommend you to set the system bus frequency over the CPU's specification because these specific bus frequencies are not the standard specifications for CPU, chipset and most of the peripherals. Whether your system can run under these specific bus frequencies properly will depend on your hardware configurations, including CPU, Chipsets, SDRAM, Cards...etc.

KT400 Series Motherboard Layout

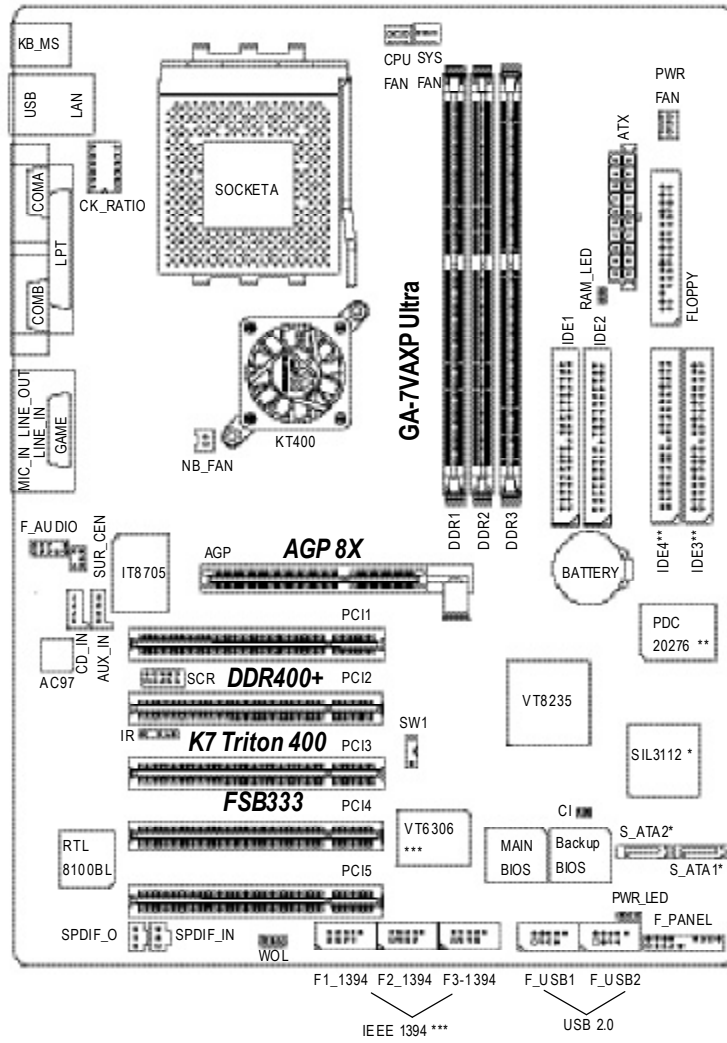

- " * " FOR GA-7VAXP Ultra Only.
- " ** " FOR GA-7VAXP Ultra / GA-7VAXP Only.
- " *** " For GA-7VAXP Ultra / GA-7VAXP / GA-7VAX1394 Only.

Chapter 2 Hardware Installation Process

To set up your computer, you must complete the following steps:

- Step 1- Set Dip Switch (CK_RATIO) and system Switch (SW1)
- Step 2- Install the Central Processing Unit (CPU)
- Step 3- Install memory modules
- Step 4- Install expansion cards
- Step 5- Connect ribbon cables, cabinet wires, and power supply
- Step 6- Setup BIOS software
- Step 7- Install supporting software tools

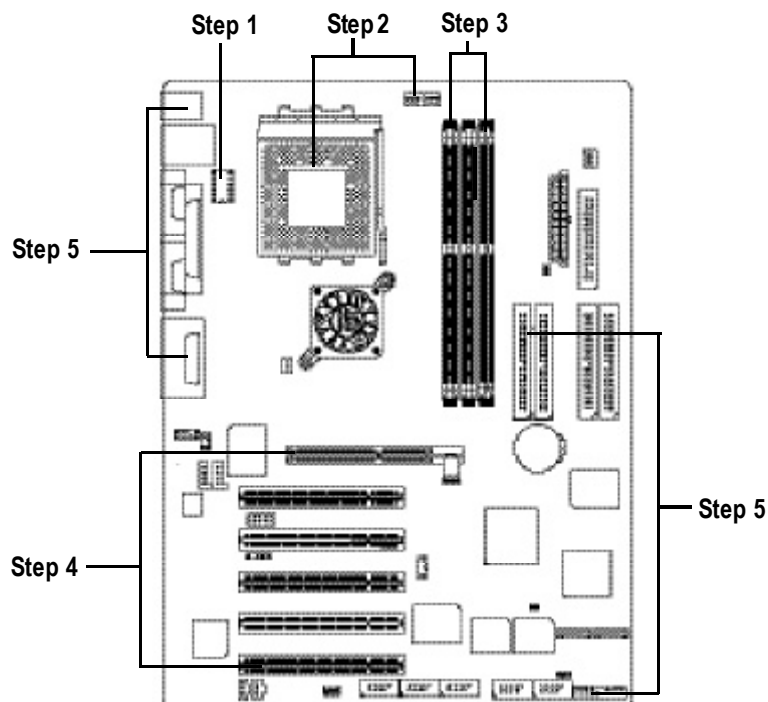

Step 1: Install the Central Processing Unit (CPU)

Step1-1: CPU Speed Setup

The clock ratio can be switched by CK_RATIO and refer to below table.

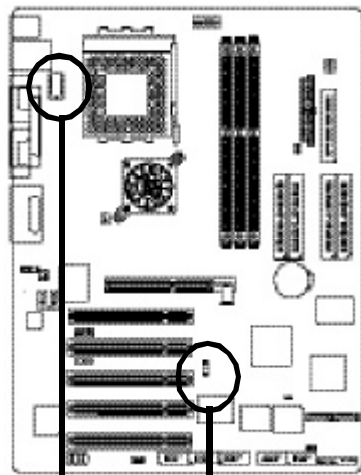

Default Setting :
Auto (X X X X X X)

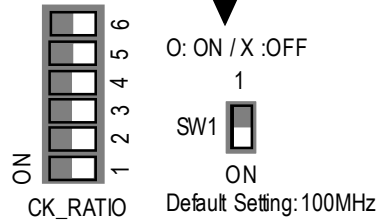

| SW1 | CPU CLOCK | |
|-----|-----------|--------|
| | | 100MHz |
| 1 | ON | OFF |

100MHz : Fix FSB 200MHz CPU

Auto : Support FSB 266/333 MHz CPU



You must set SW1 to 100MHz when you used FSB 200MHz CPU.

| CLK_RATIO | O: ON / X :OFF | | | | | |
|-------------------|----------------|---|---|---|---|---|
| RATIO | 1 | 2 | 3 | 4 | 5 | 6 |
| AUTO (Default) | X | X | X | X | X | X |
| 5x | O | O | X | O | O | O |
| 5.5x | X | O | X | O | O | O |
| 6x | O | X | X | O | O | O |
| 6.5x | X | X | X | O | O | O |
| 7x | O | O | O | X | O | O |
| 7.5x | X | O | O | X | O | O |
| 8x | O | X | O | X | O | O |
| 8.5x | X | X | O | X | O | O |
| 9x | O | O | X | X | O | O |
| 9.5x | X | O | X | X | O | O |
| 10x | O | X | X | X | O | O |
| 10.5x | X | X | X | X | O | O |
| 11x | O | O | O | O | O | O |
| 11.5x | X | O | O | O | O | O |
| 12x | O | X | O | O | O | O |
| 12.5x | X | X | O | O | O | O |
| 13x | O | O | X | O | X | O |
| 13.5x | X | O | X | O | X | O |
| 14x | O | X | X | O | X | O |
| 15x | O | O | O | X | X | O |
| 16x | O | X | O | X | X | O |
| 16.5x | X | X | O | X | X | O |
| 17x | O | O | X | X | X | O |
| 18x | X | O | X | X | X | O |

Note: In order to BIOS can auto detecting when your CPU multiplier over 18x, please adjust multiplier switch in CK Ratio to "AUTO."

Step1-2: CPU Installation

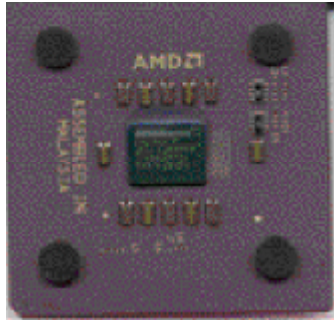

CPU Top View

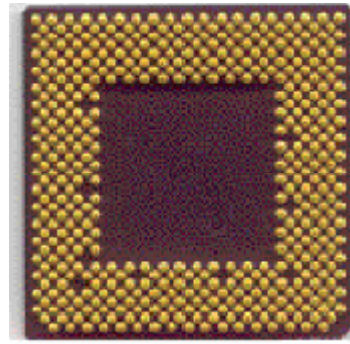

CPU Bottom View

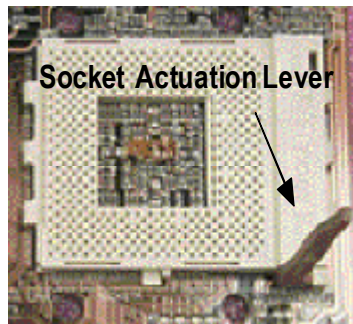

1. Pull up the CPU socket lever and up to 90-degree angle.

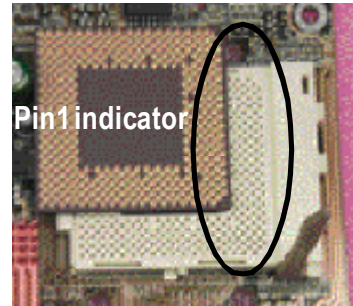

2. Locate Pin 1 in the socket and look for a (golden) cut edge on the CPU upper corner. Then insert the CPU into the socket.

- Please make sure the CPU type is supported by the motherboard.
- If you do not match the CPU socket Pin 1 and CPU cut edge well, it will cause improper installation. Please change the insert orientation.

Step1-3:CPU Heat Sink Installation

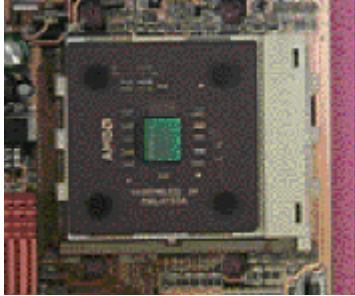

1. Press down the CPU socket lever and finish CPU installation.



2. Use qualified fan approved by AMD.

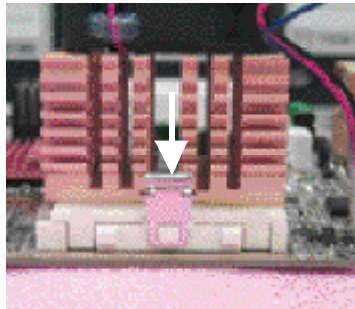

3. Fasten the heatsink supporting-base onto the CPU socket on the main-board.

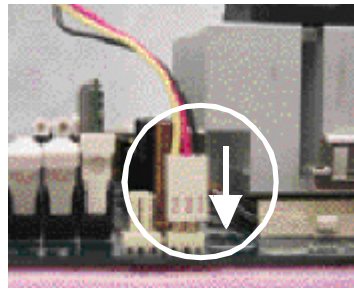

4. Make sure the CPU fan is plugged to the CPU fan connector, than install complete.

- Please use AMD approved cooling fan.
- We recommend you to apply the thermal paste to provide better heat conduction between your CPU and heatsink.
- Make sure the CPU fan power cable is plugged in to the CPU fan connector, this completes the installation.
- Please refer to CPU heat sink user's manual for more detail installation procedure.

Step 2: Install memory modules

The motherboard has 3 dual inline memory module (DIMM) sockets. The BIOS will automatically detect memory type and size. To install the memory module, just push it vertically into the DIMM Slot.

The DIMM module can only fit in one direction due to the notch. Memory size can vary between sockets.

Total Memory Sizes With Unbuffered DDR DIMM

| Devices used on DIMM | 1 DIMMx64/x72 | 2 DIMMsx64/x72 | 3 DIMMsx64/x72 |
|--------------------------|---------------|----------------|----------------|
| 64 Mbit (2Mx8x4 banks) | 128 MBytes | 256 MBytes | 384 MBytes |
| 64 Mbit (1Mx16x4 banks) | 64 MBytes | 128 MBytes | 192 MBytes |
| 128 Mbit (4Mx8x4 banks) | 256 MBytes | 512 MBytes | 768 MBytes |
| 128 Mbit (2Mx16x4 banks) | 128 MBytes | 256 MBytes | 384 MBytes |
| 256 Mbit (8Mx8x4 banks) | 512 MBytes | 1 GBytes | 1.5 GBytes |
| 256 Mbit (4Mx16x4 banks) | 256 MBytes | 512 MBytes | 768 MBytes |
| 512 Mbit (16Mx8x4 banks) | 1 GBytes | 2 GBytes | 3 GBytes |
| 512 Mbit (8Mx16x4 banks) | 512 MBytes | 1 GBytes | 1.5 GBytes |

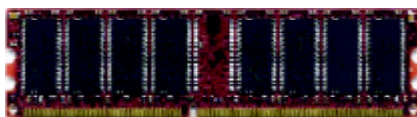

DDR

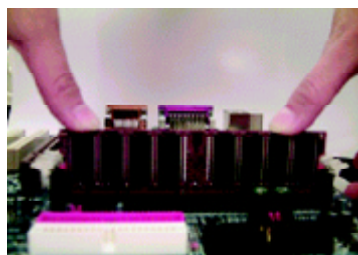

1. The DIMM slot has a notch, so the DIMM memory module can only fit in one direction.
 2. Insert the DIMM memory module vertically into the DIMM slot. Then push it down.
 3. Close the plastic clip at both edges of the DIMM slots to lock the DIMM module.
- Reverse the installation steps when you wish to remove the DIMM module.

- When STR/DIMM LED is ON, do not install/remove DIMM from socket.
- Please note that the DIMM module can only fit in one direction due to the one notch. Wrong orientation will cause improper installation. Please change the insert orientation.

DDR Introduction

Established on the existing SDRAM industry infrastructure, DDR (Double Data Rate) memory is a high performance and cost-effective solution that allows easy adoption for memory vendors, OEMs and system integrators.

DDR memory is a sensible evolutionary solution for the PC industry that builds on the existing SDRAM infrastructure, yet makes awesome advances in solving the system performance bottleneck by doubling the memory bandwidth. DDR SDRAM will offer a superior solution and migration path from existing SDRAM designs due to its availability, pricing and overall market support. PC2100 DDR memory (DDR266) doubles the data rate through reading and writing at both the rising and falling edge of the clock, achieving data bandwidth 2X greater than PC133 when running with the same DRAM clock frequency. With peak bandwidth of 2.664 GB per second, DDR memory enables system OEMs to build high performance and low latency DRAM subsystems that are suitable for servers, workstations, high-end PC's and value desktop SMA systems. With a core voltage of only 2.5 Volts compared to conventional SDRAM's 3.3 volts, DDR memory is a compelling solution for small form factor desktops and notebook applications.

Step 3: Install expansion cards

1. Read the related expansion card's instruction document before install the expansion card into the computer.
2. Remove your computer's chassis cover, necessary screws and slot bracket from the computer.
3. Press the expansion card firmly into expansion slot in motherboard.
4. Be sure the metal contacts on the card are indeed seated in the slot.
5. Replace the screw to secure the slot bracket of the expansion card.
6. Replace your computer's chassis cover.
7. Power on the computer, if necessary, setup BIOS utility of expansion card from BIOS.
8. Install related driver from the operating system.

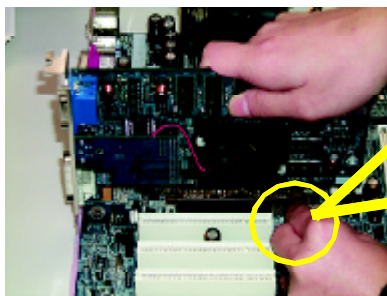

AGP Card

Please carefully pull out the small white-drawable bar at the end of the AGP slot when you try to install/ Uninstall the AGP card. Please align the AGP card to the onboard AGP slot and press firmly down on the slot. Make sure your AGP card is locked by the small white-drawable bar.

Step 4: Connect ribbon cables, cabinet wires, and power supply

Step4-1 : I/O Back Panel Introduction

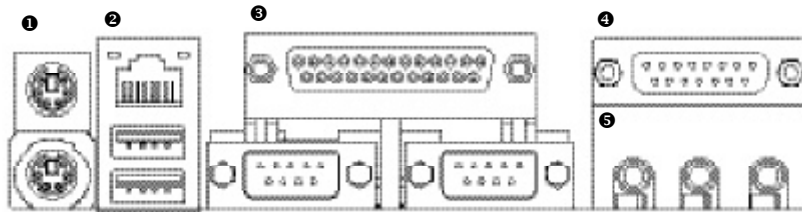

❶ PS/2 Keyboard and PS/2 Mouse Connector



PS/2 Mouse Connector
(6 pin Female)

PS/2 Keyboard Connector
(6 pin Female)

➤ This connector supports standard PS/2 keyboard and PS/2 mouse.

❷ USB/LAN Connector

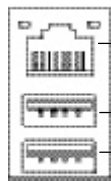

LAN Connector

USB 1

USB 0

➤ Before you connect your device(s) into USB connector(s), please make sure your device(s) such as USB keyboard, mouse, scanner, zip, speaker..etc. Have a standard USB interface. Also make sure your OS supports USB controller. If your OS does not support USB controller, please contact OS vendor for possible patch or driver upgrade. For more information please contact your OS or device(s) vendors.

③ Parallel Port and Serial Ports (COMA/COMB)

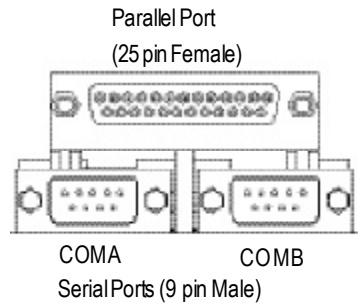

- This connector supports 2 standard COM ports and 1 Parallel port. Device like printer can be connected to Parallel port; mouse and modem etc can be connected to Serial ports.

④ Game /MIDI Ports

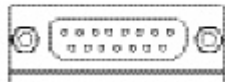

Joystick/ MIDI (15 pin Female)

- This connector supports joystick, MIDI keyboard and other related audio devices.

⑤ Audio Connectors

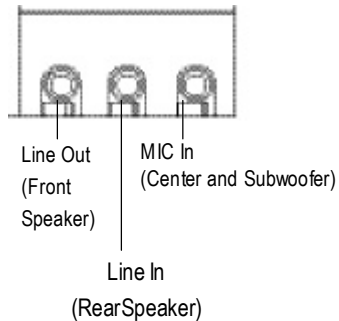

- After install onboard audio driver, you may connect speaker to Line Out jack, micro phone to MIC In jack. Device like CD-ROM, walkman etc can be connected to Line-In jack.

Please note:

You are able to use 2-/4-/6- channel audio feature by S/W selection.

If you want to enable 6-channel function, you have 2 choose for hardware connection.

Method1:

Connect "Front Speaker" to "Line Out"

Connect "Rear Speaker" to "Line In"

Connect "Center and Subwooferr" to "MIC Out".

Method2:

You can refer to page 21, and contact your nearest dealer for optional SUR_CEN cable.



If you want the detail information for 2-/4-/6-channel audio setup installation, please refer to "2-/4-/6-Channel Audio Function Introduction"

Step4-2: Connectors Introduction

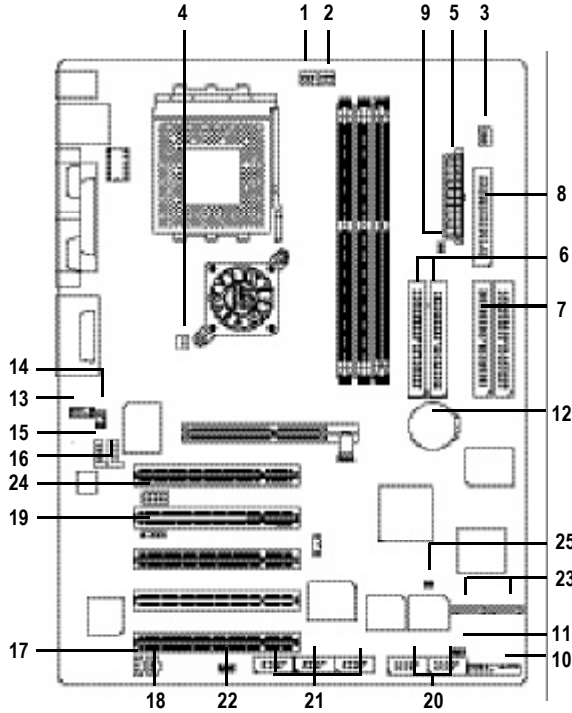

| | |
|-----------------|--------------------------------|
| 1) CPU_FAN | 13) F_AUDIO |
| 2) SYS_FAN | 14) SUR_CEN |
| 3) PWR_FAN | 15) CD_IN |
| 4) NB_FAN | 16) AUX_IN |
| 5) ATX_POWER | 17) SPDIF_O |
| 6) IDE1/IDE2 | 18) SPDIF-IN |
| 7) IDE3/IDE4 ** | 19) IR |
| 8) FDD | 20) F_USB1/F_USB2 |
| 9) RAM_LED | 21) F1_1394/F2_1394/F3_1394*** |
| 10) F_PANEL | 22) WOL |
| 11) PWR_LED | 23) S_ATA1/S_ATA2 * |
| 12) BATTERY | 24) SCR |
| | 25) CI |

** FOR GA-7VAXP Ultra Only.

** FOR GA-7VAXP Ultra / GA-7VAXP Only.

*** For GA-7VAXP Ultra / GA-7VAXP / GA-7VAX1394 Only.

1)CPU_FAN (CPU FAN Connector)

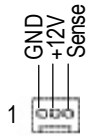

➤ Please note, a proper installation of the CPU cooler is essential to prevent the CPU from running under abnormal condition or damaged by overheating. The CPU fan connector supports Max. current up to 600 mA.

2)SYS_FAN (System FAN Connector)

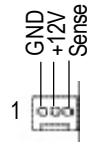

➤ This connector allows you to link with the cooling fan on the system case to lower the system temperature.

3)PWR_FAN (Power Fan Connector)

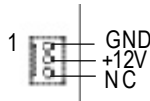

➤ This connector allows you to link with the cooling fan on the system case to lower the system temperature.

4)NB_FAN

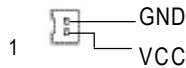

➤ If you installed wrong direction, the Chip Fan will not work. Sometimes will damage the Chip Fan. (Usually black cable is GND)

5)ATX_POWER (ATX Power)

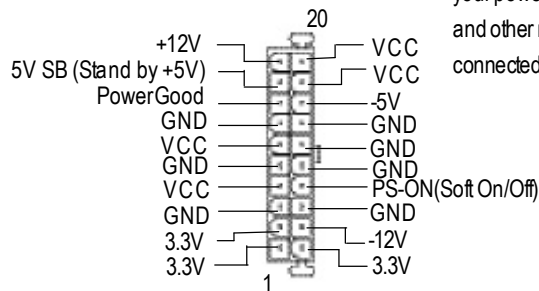

➤ AC power cord should only be connected to your power supply unit after ATX power cable and other related devices are firmly connected to the mainboard.

6)IDE1/ IDE2 (IDE1/IDE2 Connector)

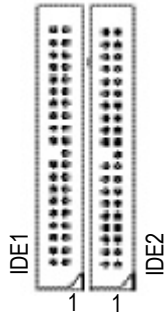

- Important Notice:
Please connect first harddisk to IDE1 and connect CDROM to IDE2.
The red stripe of the ribbon cable must be the same side with the Pin1.

**7)IDE3/IDE4 Connector **
(RAID/ATA133,Green Connector)**

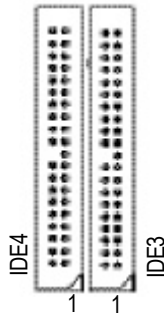

- **Important Notice:**
 1. The red stripe of the ribbon cable must be the same side with the Pin1.
 2. If you wish to use IDE3 and IDE4, please use it in unity with BIOS (either RAID or ATA133). Then, install the correct driver to have proper operation. For details, please refer to the PROMISE RAID manual.

8)FDD (Floppy Connector)

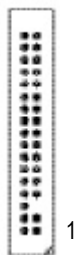

- Please connect the floppy drive ribbon cables to FDD. It supports 360K,720K,1.2M,1.44M and 2.88Mbytes floppy disk types.
The red stripe of the ribbon cable must be the same side with the Pin1.

**** " FOR GA-7VAXP Ultra / GA-7VAXP Only.**

9)RAM_LED



- Do not remove memory modules while DIMM LED is on. It might cause short or other unexpected damages due to the 2.5V stand by voltage. Remove memory modules only when AC Power cord is disconnected.

10)F_PANEL (2x10 pins connector)

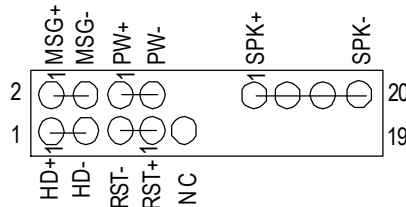

| | |
|--|--|
| HD (IDE Hard Disk Active LED) (Blue) | Pin 1: LED anode(+) Pin 2: LED cathode(-) |
| SPK(Speaker Connectr) (Amber) | Pin 1: VCC(+) Pin 2- Pin 3: NC Pin 4: Data(-) |
| RST (Reset Switch) (Green) | Open: Normal Operation Close: Reset Hardware System |
| PW (Soft Power Connector) (Red) | Open: Normal Operation Close: Power On/Off |
| MSG(Message LED/Power/ Sleep LED)(Yellow) | Pin 1: LED anode(+) Pin 2: LED cathode(-) |
| NC (Purple) | NC |

- Please connect the power LED, PC speaker, resetswitch and power switch etc of your chassis front panel to the F_PANEL connector according to the pin assignment above.

11)PWR_LED

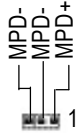

- PWR_LED is connect with the system power indicator to indicate whether the system is on/off. It will blink when the system enters suspend mode.
- If you use dual color LED, power LED will turn to another color.

12)BATTERY

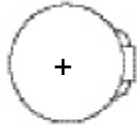

CAUTION

- ❖ Danger of explosion if battery is incorrectly replaced.
- ❖ Replace only with the same or equivalent type recommended by the manufacturer.
- ❖ Dispose of used batteries according to the manufacturer's instructions.

13)F_AUDIO (F_AUDIO Connector)

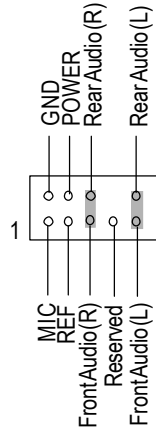

- If you want to use Front Audio connector, you must remove 5-6, 9-10 Jumper.
- In order to utilize the front audio header, your chassis must have front audio connector. Also please make sure the pin assignment on the cable is the same as the pin assignment on the MB header. To find out if the chassis you are buying support front audio connector, please contact your dealer.

14) SUR_CEN

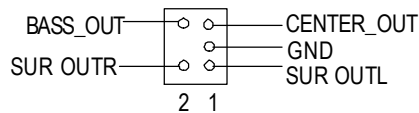

- Please contact your nearest dealer for optional SUR_CEN cable.

15)CD_IN (CD IN)

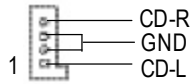

- Connect CD-ROM or DVD-ROM audio out to the connector.

16)AUX_IN (AUX In Connector)

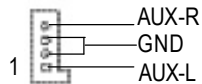

- Connect other device (such as PC/TV Tuner audio out) to the connector.

17)SPDIF_O (SPDIFOut)

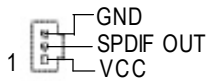

- The SPDIF output is capable of providing digital audio to external speakers or compressed AC3 data to an external Dolby Digital Decoder. Use this feature only when your stereo system has digital input function.

18)SPDIF_IN

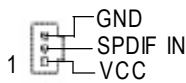

- Use this feature only when your device has digital output function.

19)IR



- Be careful with the polarity of the IR connector while you connect the IR. Please contact your nearest dealer for optional IR device.

**20) F_USB1 / F_USB2
(Front USB Connector, Yellow)**

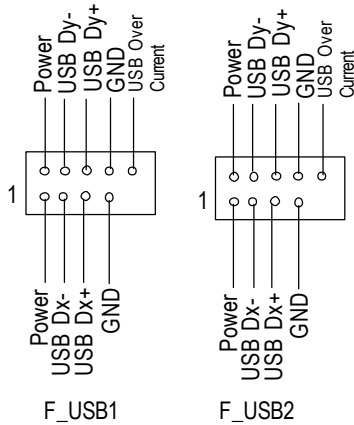

- Be careful with the polarity of the front USB connector. Check the pin assignment while you connect the front USB cable. Please contact your nearest dealer for optional front USB cable.

21) F1_1394/F2_1394/F3_1394 (IEEE1394 Connector, Gray Connector)***

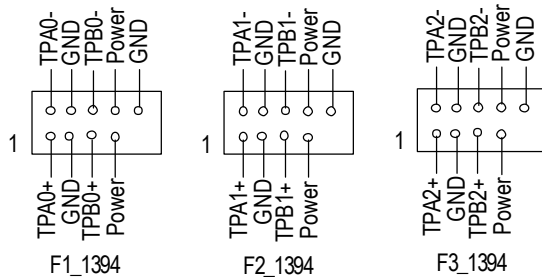

- **Please Note:** Serial interface standard set by Institute of Electrical and Electronics Engineers, which has features like high speed, high bandwidth and hotplug.

22) WOL (Wake on LAN)

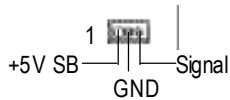

- This connector allows the remote servers to manage the system that installed this mainboard via your network adapter which also supports WOL.

*** FOR GA-7VAXP Ultra Only.
 *** FOR GA-7VAXP Ultra / GA-7VAXP Only.
 *** For GA-7VAXP Ultra / GA-7VAXP / GA-7VAX1394 Only.

23) S_ATA1/S_ATA2 (SerialATA Connector) *

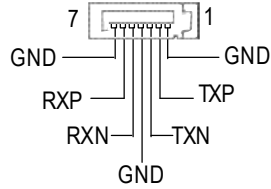

- You can connect the SerialATA device to this connector, it provides you high speed transfer rates (150MB/sec).

24) SCR (Smart Card Reader Header)

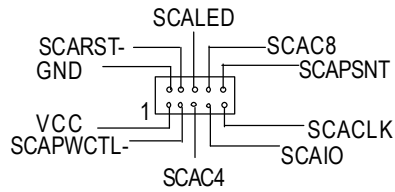

- This MB supports smart card reader. To enable smartcard reader function an optional smart card reader box is required. Please contact your authorized distributor.

25) CI (CASE OPEN)

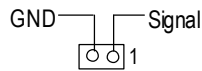

- This 2 pin connector allows your system to enable or disable the "case open" item in BIOS if the system case begin remove.

***** FOR GA-7VAXP Ultra Only.**

Chapter 3 BIOS Setup

BIOS Setup is an overview of the BIOS Setup Program. The program that allows users to modify the basic system configuration. This type of information is stored in battery-backed CMOS RAM so that it retains the Setup information when the power is turned off.

ENTERING SETUP

After power on the computer, pressing immediately during POST (Power On Self Test) it will allow you to enter standard BIOS CMOS SETUP.

If you require more advanced BIOS settings, please go to "Advanced BIOS" setting menu. To enter Advanced BIOS setting menu, press "Ctrl+F1" key on the BIOS screen.

CONTROL KEYS

| | |
|----------|---|
| <↑> | Move to previous item |
| <↓> | Move to next item |
| <←> | Move to the item in the left hand |
| <→> | Move to the item in the right hand |
| <Esc> | Main Menu - Quit and not save changes into CMOS Status Page Setup Menu and Option Page Setup Menu - Exit current page and return to Main Menu |
| <+/PgUp> | Increase the numeric value or make changes |
| <-/PgDn> | Decrease the numeric value or make changes |
| <F1> | General help, only for Status Page Setup Menu and Option Page Setup Menu |
| <F2> | Item help |
| <F3> | Reserved |
| <F4> | Reserved |
| <F5> | Restore the previous CMOS value from CMOS, only for Option Page Setup Menu |
| <F6> | Load the default CMOS value from BIOS default table, only for Option Page Setup Menu |
| <F7> | Load the Setup Defaults |
| <F8> | Dual BIOS/Q-Flash |
| <F9> | Reserved |
| <F10> | Save all the CMOS changes, only for Main Menu |

GETTING HELP

Main Menu

The on-line description of the highlighted setup function is displayed at the bottom of the screen.

Status Page Setup Menu / Option Page Setup Menu

Press F1 to pop up a small help window that describes the appropriate keys to use and the possible selections for the highlighted item. To exit the Help Window press <Esc>.

The Main Menu (For example: BIOS Ver. : F8)

Once you enter Award BIOS CMOS Setup Utility, the Main Menu (Figure 1) will appear on the screen. The Main Menu allows you to select from eight setup functions and two exit choices. Use arrow keys to select among the items and press <Enter> to accept or enter the sub-menu.

CMOS Setup Utility - Copyright (C) 1984-2002 Award Software

| | |
|---|---|
| <ul style="list-style-type: none"> ▶ Standard CMOS Features ▶ Advanced BIOS Features ▶ Integrated Peripherals ▶ Power Management Setup ▶ PnP/PCI Configurations ▶ PC Health Status ▶ Frequency/Voltage Control | <ul style="list-style-type: none"> Top Performance Load Fail-Safe Defaults Load Optimized Defaults Set Supervisor Password Set User Password Save & Exit Setup Exit Without Saving |
| ESC:Quit | ↑↓→←: Select Item |
| F8: Dual BIOS / Q-Flash | F10: Save & Exit Setup |
| Time, Date, Hard Disk Type... | |

Figure 1: Main Menu

- **Standard CMOS Features**
This setup page includes all the items in standard compatible BIOS.
- **Advanced BIOS Features**
This setup page includes all the items of Award special enhanced features.
- **Integrated Peripherals**
This setup page includes all onboard peripherals.

- **Power Management Setup**
This setup page includes all the items of Green function features.
- **PnP/PCI Configurations**
This setup page includes all the configurations of PCI & PnP ISA resources.
- **PC Health Status**
This setup page is the System auto detect Temperature, voltage, fan, speed.
- **Frequency/Voltage Control**
This setup page is control CPU's clock and frequency ratio.
- **Top Performance**
Top Performance Defaults indicates the value of the system parameters which the system would be in best performance configuration.
- **Load Fail-Safe Defaults**
Fail-Safe Defaults indicates the value of the system parameters which the system would be in safe configuration.
- **Load Optimized Defaults**
Optimized Defaults indicates the value of the system parameters which the system would be in better performance configuration.
- **Load Top Performance Defaults**
Top Performance Defaults indicates the value of the system parameters which the system would be in best performance configuration.
- **Set Supervisor password**
Change, set, or disable password. It allows you to limit access to the system and Setup, or just to Setup.
- **Set User password**
Change, set, or disable password. It allows you to limit access to the system.
- **Save & Exit Setup**
Save CMOS value settings to CMOS and exit setup.
- **Exit Without Saving**
Abandon all CMOS value changes and exit setup.

Standard CMOS Features

CMOS Setup Utility - Copyright (C) 1984-2002 Award Software

| Standard CMOS Features | | |
|--|---------------------|-----------------------------|
| | | Item Help |
| Date(mm:dd:yy) | Thu, Feb 21 2002 | |
| Time(hh:mm:ss) | 22:31:24 | ←→←→←→←→ |
| } IDE Primary Master | [Press Enter None] | Change the day, month, |
| ▶ IDE Primary Slave | [Press Enter None] | year |
| ▶ IDE Secondary Master | [Press Enter None] | <Week> |
| ▶ IDE Secondary Slave | [Press Enter None] | Sun. to Sat. |
| Drive A | [1.44M, 3.5"] | <Month> |
| Drive B | [None] | Jan. to Dec. |
| Floppy 3 Mode Support | [Disabled] | <Day> |
| | | 1 to 31 (or maximum allowed |
| Halt On | [All, But Keyboard] | in the month.) |
| Base Memory | 640K | <year> |
| Extended Memory | 130048K | 1999 to 2098 |
| Total Memory | 131072K | |
| ↑↓→←: Move Enter: Select +/-/PU/PD: Value F10: Save ESC: Exit F1: General Help | | |
| F5: Previous Values F6: Fail-Safe Defaults F7: Optimized Defaults | | |

Figure 2: Standard CMOS Features

☞ Date

The date format is <week>, <month>, <day>, <year>.

- ▶▶ Week The week, from Sun to Sat, determined by the BIOS and is display only
- ▶▶ Month The month, Jan. Through Dec.
- ▶▶ Day The day, from 1 to 31 (or the maximum allowed in the month)
- ▶▶ Year The year, from 1999 through 2098

☞ Time

The times format in <hour> <minute> <second>. The time is calculated base on the 24-hour military-time clock. For example, 1 p.m. is 13:00:00.

☞ IDE Primary Master, Slave / Secondary Master, Slave

The category identifies the types of hard disk from drive C to F that has been installed in the computer. There are two types: auto type, and manual type. Manual type is user-definable; Auto type which will automatically detect HDD type.

Note that the specifications of your drive must match with the drive table. The hard disk will not work properly if you enter improper information for this category.

If you select User Type, related information will be asked to enter to the following items. Enter the information directly from the keyboard and press <Enter>. Such information should be provided in the documentation from your hard disk vendor or the system manufacturer.

- ▶▶ Capacity: The hard disk size. The unit is Mega Bytes.
- ▶▶ Access Mode: The options are: Auto/ Large/ LBA/ Normal.
- ▶▶ Cylinder: The cylinder number of hard disk.
- ▶▶ Head: The read /Write head number of hard disk.
- ▶▶ Precomp: The cylinder number at which the disk driver changes the write current.
- ▶▶ Landing Zone: The cylinder number that the disk driver heads (read/write) are seated when the disk drive is parked.
- ▶▶ SECTORS: The sector number of each track define on the hard disk.

If a hard disk has not been installed select NONE and press <Enter>.

☞ Drive A / Drive B

The category identifies the types of floppy disk drive A or drive B that has been installed in the computer.

- ▶▶ None: No floppy drive installed
- ▶▶ 360K, 5.25": 5.25 inch PC-type standard drive; 360K byte capacity.
- ▶▶ 1.2M, 5.25": 5.25 inch AT-type high-density drive; 1.2M byte capacity (3.5 inch when 3 Mode is Enabled).
- ▶▶ 720K, 3.5": 3.5 inch double-sided drive; 720K byte capacity
- ▶▶ 1.44M, 3.5": 3.5 inch double-sided drive; 1.44M byte capacity.
- ▶▶ 2.88M, 3.5": 3.5 inch double-sided drive; 2.88M byte capacity.

☞ Floppy 3 Mode Support (for Japan Area)

- ▶▶ Disabled: Normal Floppy Drive. (Default value)
- ▶▶ Drive A: Enabled 3 mode function of Drive A.
- ▶▶ Drive B: Enabled 3 mode function of Drive B.
- ▶▶ Both: Drive A & Bare 3 mode Floppy Drives.

Halt on

The category determines whether the computer will stop if an error is detected during power up.

- ▶▶ NO Errors The system boot will not stop for any error that may be detected and you will be prompted.
- ▶▶ All Errors Whenever the BIOS detects a non-fatal error the system will be stopped.
- ▶▶ All, But Keyboard The system boot will not stop for a keyboard error; it will stop for all other errors. (Default value)
- ▶▶ All, But Diskette The system boot will not stop for a disk error; it will stop for all other errors.
- ▶▶ All, But Disk/Key The system boot will not stop for a keyboard or disk error; it will stop for all other errors.

Memory

The category is display-only which is determined by POST (Power On Self Test) of the BIOS.

Base Memory

The POST of the BIOS will determine the amount of base (or conventional) memory installed in the system.

The value of the base memory is typically 512 K for systems with 512 K memory installed on the motherboard, or 640 K for systems with 640 K or more memory installed on the motherboard.

Extended Memory

The BIOS determines how much extended memory is present during the POST.

This is the amount of memory located above 1 MB in the CPU's memory address map.

Advanced BIOS Features

CMOS Setup Utility - Copyright (C) 1984-2002 Award Software

Advanced BIOS Features

| | | |
|---|--------------|------------|
| SATA / RAID / SCSI Boot Order * | [SCSI] | Item Help |
| (RAID/SCAI Boot Order) ** | [RAID, SCSI] | Menu Level |
| First Boot Device | [Floppy] | |
| Second Boot Device | [HDD-0] | |
| Third Boot Device | [CDROM] | |
| Boot Up Floppy Seek | [Disabled] | |
| Password Check | [Setup] | |
| Flexible AGP 8X | [Auto] | |
| Init Display First | [AGP] | |
| ↑↓→←: Move Enter:Select +/-/PU/PD:Value F10:Save ESC:Exit F1:General Help F5:Previous Values F6:Fail-Safe Defaults F7:Optimized Defaults | | |

Figure 3: Advanced BIOS Features

☞ SATA / RAID / SCSI Boot Order *

- ☛ This feature allows you to select the boot order RAID , SCSI or SATA device.
 - ▶▶ RAID Select your boot device priority by RAID.
 - ▶▶ SCSI Select your boot device priority by SCSI.(Default value)
 - ▶▶ SATA Select your boot device priority by SATA.

☞ RAID / SCSI Boot Order **

- ☛ This feature allows you to select the boot order RAID , SCSI device.
 - ▶▶ RAID,SCSI Select your boot device priority by RAID.(Default value)
 - ▶▶ SCSI,RAID Select your boot device priority by SCSI.

☞ First / Second / Third Boot device

- ☛ This feature allows you to select the boot device priority .
 - ▶▶ Floppy Select your boot device priority by Floppy .
 - ▶▶ LS120 Select your boot device priority by LS120.
 - ▶▶ HDD-0~3 Select your boot device priority by HDD-0~3.
 - ▶▶ SCSI Select your boot device priority by SCSI.

** " FOR GA-7VAXP Ultra Only.

" ** " FOR GA-7VAXP Ultra / GA-7VAXP Only.

- » CDROM Select your boot device priority by CDROM.
- » LAN Select your boot device priority by LAN.
- » USB-CDROM Select your boot device priority by USB-CDROM.
- » USB-ZIP Select your boot device priority by USB-ZIP.
- » USB-FDD Select your boot device priority by USB-FDD.
- » USB-HDD Select your boot device priority by USB-HDD.
- » ZIP Select your boot device priority by ZIP.
- » Disabled Disabled this function.

☞ **Boot Up Floppy Seek**

☛ During POST, BIOS will determine the floppy disk drive installed is 40 or 80 tracks. 360 K type is 40 tracks 720 K, 1.2 M and 1.44 M are all 80 tracks.

- » Enabled BIOS searches for floppy disk drive to determine it is 40 or 80 tracks. Note that BIOS can not tell from 720 K, 1.2 M or 1.44 M drive type as they are all 80tracks.
- » Disabled BIOS will not search for the type of floppy disk drive by track number. Note that there will not be any warning message if the drive installed is 360 K.
(Default value)

☞ **Password Check**

- » System The system can not boot and can not access to Setup page will be denied if the correct password is not entered at the prompt.
- » Setup The system will boot, but access to Setup will be denied if the correct password is not entered at the prompt. (Default value)

☞ **Flexible AGP 8X**

- » Auto Automatically set AGP transfer rate according to AGP compatibility and stability.
(Default value)
- » 8X Always set AGP transfer rate to 8X if the 8X mode supported by the AGP card.
- » 4X Set AGP transfer rate to 4X mode no matter what the AGP transfer rate the card is.

☞ **Init Display First**

☛ This feature allows you to select the first initiation of the monitor display from which card, when you install an AGP VGA card and a PCI VGA card on board.

- » PCI Set Init Display First to PCI Slot.
- » AGP Set Init Display First to AGP. (Default value)

Integrated Peripherals

CMOS Setup Utility - Copyright (C) 1984-2002 Award Software

Integrated Peripherals

| | | |
|---|------------|------------|
| OnChip IDE Channel0 | [Enabled] | Item Help |
| OnChip IDE Channel1 | [Enabled] | Menu Level |
| IDE1 Conductor Cable | [Auto] | |
| IDE2 Conductor Cable | [Auto] | |
| AC97 Audio | [Enabled] | |
| USB 1.1 Controller | [Enabled] | |
| USB 2.0 Controller | [Enabled] | |
| USB Keyboard Support | [Disabled] | |
| USB Mouse Support | [Disabled] | |
| Onboard H/W LAN | [Enabled] | |
| Onboard H/W 1394 *** | [Enabled] | |
| Onboard H/W ATA/RAID ** | [Enabled] | |
| RAID Controller Function ** | [ATA] | |
| Onboard H/W Serial ATA * | [Enabled] | |
| Serial ATA Function * | [RAID] | |
| Onboard Serial Port 1 | [3F8/IRQ4] | |
| Onboard Serial Port 2 | [2F8/IRQ3] | |
| UART Mode Select | [Normal] | |
| ⊗UR2 Duplex Mode | Half | |
| Onboard Parallel Port | [378/IRQ7] | |
| Parallel Port Mode | [SPP] | |
| Game Port Address | [201] | |
| Mdi Port Address | [330] | |
| Midi Port IRQ | [5] | |
| ↑↓→←: Move Enter:Select +/-/PU/PD:Value F10:Save ESC:Exit F1:General Help F5:Previous Values F6:Fail-Safe Defaults F7:Optimized Defaults | | |

Figure 4: Integrated Peripherals

*** FOR GA-7VAXP Ultra Only.

** FOR GA-7VAXP Ultra / GA-7VAXP Only.

*** For GA-7VAXP Ultra / GA-7VAXP / GA-7VAX1394 Only.

☞ OnChip IDE Channel0

● When enabled, allows you to use the onboard primary PCI IDE. If a hard disk controller card is used, set at Disabled.

- ▶▶ Enabled Enable onboard 1st channel IDE port. (Default value)
- ▶▶ Disabled Disable onboard 1st channel IDE port.

☞ OnChip IDE Channel1

● When enabled, allows you to use the onboard secondary PCI IDE. If a hard disk controller card is used, set at Disabled.

- ▶▶ Enabled Enable onboard 2nd channel IDE port. (Default value)
- ▶▶ Disabled Disable onboard 2nd channel IDE port.

☞ IDE1 Conductor Cable

▶▶ Auto Will be automatically detected by BIOS (Default Value)

▶▶ ATA66/100/133 Set IDE1 Conductor Cable to ATA66/100/133 (Please make sure your IDE device

and cable is compatible with ATA66/100/133)

▶▶ ATA33 Set IDE1 Conductor Cable to ATA33 (Please make sure your IDE device and cable is compatible with ATA33)

☞ IDE2 Conductor Cable

▶▶ Auto Will be automatically detected by BIOS (Default Value)

▶▶ ATA66/100/133 Set IDE2 Conductor Cable to ATA66/100/133 (Please make sure your IDE device

and cable is compatible with ATA66/100/133)

▶▶ ATA33 Set IDE2 Conductor Cable to ATA33 (Please make sure your IDE device and cable is compatible with ATA33).

☞ AC97 Audio

- ▶▶ Enabled Enabled Onchip AC97 controller. (Default value)
- ▶▶ Disabled Disabled Onchip AC97 controller.

☞ USB 1.1 Controller

● Disable this option if you are not using the onboard USB feature.

- ▶▶ Enabled Enabled USB1.1 Controller. (Default value)
- ▶▶ Disabled Disabled USB1.1 Controller.

☞ USB 2.0 Controller

◆ Disable this option if you are not using the onboard USB 2.0 feature.

- ▶▶ Enabled Enabled USB 2.0 Controller. (Default value)
- ▶▶ Disabled Disabled USB 2.0 Controller.

☞ USB Keyboard Support

◆ When a USB keyboard is installed, please set at Enabled.

- ▶▶ Enabled Enabled USB Keyboard Support.
- ▶▶ Disabled Disabled USB Keyboard Support. (Default value)

☞ USB Mouse Support

- ▶▶ Enabled Enabled USB Mouse Support.
- ▶▶ Disabled Disabled USB Mouse Support. (Default value)

☞ Onboard H/W LAN

- ▶▶ Enable Enabled onboard LAN function.(Default value)
- ▶▶ Disable Disable onboard LAN function.

☞ Onboard H/W 1394 ***

- ▶▶ Enable Enabled onboard IEEE 1394 function.(Default value)
- ▶▶ Disable Disabled onboard this function.

☞ Onboard H/W ATA/RAID **

◆ If you don't set any HDD Device in IDE3 or 4 but enable the function, the normal message 'MBUltra133 BIOS is not installed because there are no drives attached' will come out.

Ignore this message or set the option disable to make the message disappear.

- ▶▶ Enable Enabled onboard ATA/RAID function. (Default value)
- ▶▶ Disable Disabled onboard sound function.

☞ RAID Controller Function **

- ▶▶ ATA Select onboard RAID chip function as ATA.(Default value)
- ▶▶ RAID Select onboard RAID chip function as RAID.

☞ Onboard H/W Serial ATA *

- ▶▶ Enabled Enabled Onboard H/W Serial ATA support.(Default value)
- ▶▶ Disabled Disabled Onboard H/W Serial ATA .

" * " FOR GA-7VAXP Ultra Only.

" ** " FOR GA-7VAXP Ultra / GA-7VAXP Only.

" *** " For GA-7VAXP Ultra / GA-7VAXP / GA-7VAX1394 Only.

☞ **Serial ATA Function ***

- ▶▶ RAID Select onboard Serial ATA chip function as RAID.(Default value)
- ▶▶ BASE Select onboard Serial ATA chip function as BASE.

☞ **Onboard Serial Port 1**

- ▶▶ Auto BIOS will automatically setup the port 1 address.
- ▶▶ 3F8/IRQ4 Enable onboard Serial port 1 and address is 3F8,Using IRQ4. (Default value)
- ▶▶ 2F8/IRQ3 Enable onboard Serial port 1 and address is 2F8,Using IRQ3.
- ▶▶ 3E8/IRQ4 Enable onboard Serial port 1 and address is 3E8,Using IRQ4.
- ▶▶ 2E8/IRQ3 Enable onboard Serial port 1 and address is 2E8,Using IRQ3.
- ▶▶ Disabled Disable onboard Serial port 1.

☞ **Onboard Serial Port 2**

- ▶▶ Auto BIOS will automatically setup the port 2 address.
- ▶▶ 3F8/IRQ4 Enable onboard Serial port 2 and address is 3F8,Using IRQ4.
- ▶▶ 2F8/IRQ3 Enable onboard Serial port 2 and address is 2F8,Using IRQ3. (Default Value)
- ▶▶ 3E8/IRQ4 Enable onboard Serial port 2 and address is 3E8,Using IRQ4.
- ▶▶ 2E8/IRQ3 Enable onboard Serial port 2 and address is 2E8,Using IRQ3.
- ▶▶ Disabled Disable onboard Serial port 2.

☞ **UART Mode Select**

◆ This feature allows you to determine which Infra Red(IR) function of Onboard I/O chip)

- ▶▶ ASKIR Using as IR and set to ASKIR Mode.
- ▶▶ IrDA Using as IR and set to IrDA Mode.
- ▶▶ Normal Using as standard serial port. (Default Value)
- ▶▶ SCR **Using as smart card Interface.**

☞ **UR2 Duplex Mode(When UART Mode Select isn't set [Normal])**

◆ This feature allows you to select the IR modes.

- ▶▶ Half IR Function Duplex Half. (Default Value)
- ▶▶ Full IR Function Duplex Full.

" * " FOR GA-7VAXP Ultra Only.

☞ **OnBoard Parallel port**

● This feature allows you to select from a given set of parameters if the parallel port uses the onboard I/O controller.

- ▶▶ 378/IRQ7 Enable onboard LPT port and address is 378, Using IRQ7.(Default Value)
- ▶▶ 278/IRQ5 Enable onboard LPT port and address is 278,Using IRQ5.
- ▶▶ 3BC/IRQ7 Enable onboard LPT port and address is 3BC,Using IRQ7.
- ▶▶ Disabled Disable onboard parallel port.

☞ **Parallel Port Mode**

● This feature allows you to connect with an advanced print via the port mode it supports.

- ▶▶ SPP Using Parallel port as Standard Parallel Port using IRQ7. (Default Value)
- ▶▶ EPP Using Parallel port as Enhanced Parallel Port IRQ5.
- ▶▶ ECP Using Parallel port as Extended Capabilities Port using IRQ7.
- ▶▶ ECP+EPP Using Parallel port as ECP & EPP mode.

☞ **Game Port Address**

- ▶▶ Disabled Disabled this function.
- ▶▶ 201 Set Game Port Address to 201. (Default Value)
- ▶▶ 209 Set Game Port Address to 209.

☞ **Midi Port Address**

- ▶▶ Disabled Disabled this function.
- ▶▶ 300 Set Midi Port Address to 300.
- ▶▶ 330 Set Midi Port Address to 330.(Default Value)

☞ **Midi Port IRQ**

- ▶▶ 5 Set 5 for Midi Port IRQ. (Default value)
- ▶▶ 10 **Set 10 for Midi Port IRQ.**

Power Management Setup

CMOS Setup Utility - Copyright (C) 1984-2002 Award Software

Power Management Setup

| | | |
|---|---------------|------------|
| ACPI Suspend Type | [S1(POS)] | Item Help |
| ※USB Device Wake-Up From S3 | Disabled | Menu Level |
| Power LED in S1 state | [Blinking] | |
| Soft-Off by PWRBTN | [Instant-off] | |
| AC Back Function | [Soft-Off] | |
| Keyboard Power On | [Disabled] | |
| Mouse Power On | [Disabled] | |
| PME Event Wake Up | [Enabled] | |
| Modem Ring On/Wake On LAN | [Enabled] | |
| Resume by Alarm | [Disabled] | |
| ※ Date (of Month) Alarm | Everyday | |
| ※ Time (hh:mm:ss) Alarm | 0 : 0 : 0 | |
| ↑↓→←: Move Enter: Select +/-/PU/PD: Value F10: Save ESC: Exit F1: General Help F5: Previous Values F6: Fail-Safe Defaults F7: Optimized Defaults | | |

Figure 5: Power Management Setup

☞ ACPI Suspend Type

- ▶▶ S1/POS Set suspend type to Power On Suspend under ACPI OS (Power On Suspend). (Default value)
- ▶▶ S3/STR Set suspend type to Suspend To RAM under ACPI OS (Suspend To RAM).

☞ USB Device Wakeup From S3 (When ACPI Suspend Type is set [S3/STR])

USB device wakeup From S3 can be set when ACPI standby state set to S3/STR.

- ▶▶ Enabled USB Device can wakeup system from S3.
- ▶▶ Disabled USB Device can't wakeup system from S3. (Default value)

☞ Power LED in S1 state

- ▶▶ Blinking In standby mode(S1), power LED will blink. (Default Value)
- ▶▶ Dual/Off In standby mode(S1):
 - a. If use single color LED, power LED will turn off.
 - b. If use dual color LED, power LED will turn to another color.

☞ Soft-off by PWRBTN

- ▶▶ Instant-off Press power button then Power off instantly. (Default value)
- ▶▶ Delay 4 Sec. Press power button 4 sec to Power off. Enter suspend if button is pressed less than 4 sec.

☞ ACBack Function

- ▶▶ Memory System power on depends on the status before AC lost.
- ▶▶ Soft-Off Always in Off state when AC back. (Default value)
- ▶▶ Full-On Always power on the system when AC back.

☞ Keyboard Power On

This feature allows you to set the method for powering-on the system.

The option "Password" allows you to set up to 8 alphanumeric characters to power-on the system.

The option "Any Key" allows you to touch the keyboard to power on the system.

The option "Keyboard 98" allows you to use the standard keyboard 98 to power on the system.

- ▶▶ Password Enter from 1 to 8 characters to set the Keyboard Power On Password.
- ▶▶ Disabled Disabled this function. (Default value)
- ▶▶ Keyboard 98 If your keyboard have "POWER Key" button, you can press the key to power on your system.

☞ Mouse Power On

- ▶▶ Disabled Can't Power on system by Mouse Event. (Default value)
- ▶▶ Enabled Can Power on system by Mouse Event.

☞ **PME Event Wake up**

- ☞ When set at Enabled, any PCI-PM event awakes the system from a PCI-PM controlled state.
- ☞ This feature requires an ATX power supply that provides at least 1A on the +5VSB lead.
 - ▶▶ Disabled Disabled PME Event Wake up function.
 - ▶▶ Enabled Enabled PME Event Wake up function. (Default Value)

☞ **ModemRing On/ WakeOnLAN (WhenAC Back Function is set to [Soft-Off])**

- ☞ You can enable wake on LAN feature by the "ModemRingOn/WakeOnLAN" or "PME Event Wake up" when the M/B has "WOL" onboard connector. Only enabled the feature by "PME Event Wake up".
- ☞ An incoming call via modem awakes the system from its soft-off mode.
- ☞ When set at Enabled, an input signal comes from the other client.
 - Server on the LAN awakes the system from a soft off state if connected over LAN.
 - ▶▶ Disabled Disabled Modem Ring On / Wake On LAN function.
 - ▶▶ Enabled Enabled Modem Ring On / Wake On LAN function. (Default Value)

☞ **Resume by Alarm**

You can set "Resume by Alarm" item to enabled and key in Date/time to power on system.

- ▶▶ Disabled Disable this function. (Default Value)
- ▶▶ Enabled Enable alarm function to POWER ON system.

If RTC Alarm Lead To Power On is Enabled.

Date (of Month) Alarm : Every day, 1~31

Time (hh: mm: ss) Alarm : (0~23) : (0~59) : (0~59)

PnP/PCI Configurations

CMOS Setup Utility - Copyright (C) 1984-2002 Award Software

PnP/PCI Configurations

| | | |
|--|--------|-----------|
| PCI1/PCI5 IRQ Assignment | [Auto] | Item Help |
| PCI2 IRQ Assignment | [Auto] | MenuLevel |
| PCI3 IRQ Assignment | [Auto] | |
| PCI4 IRQ Assignment | [Auto] | |
| ↑↓→←: Move Enter:Select+/-/PU/PD:Value F10:Save ESC:Exit F1:General Help F5:Previous Values F6:Fail-Safe Defaults F7:Optimized Defaults | | |

Figure 6: PnP/PCI Configurations

☞ PCI1/PCI5 IRQ Assignment

- ▶▶ Auto Auto assign IRQ to PCI 1/ PCI 5. (Default value)
- ▶▶ 3,4,5,7,9,10,11,12,14,15 Set3,4,5,7,9,10,11,12,14,15 to PCI1/ PCI5.

☞ PCI2 IRQ Assignment

- ▶▶ Auto Auto assign IRQ to PCI 2. (Default value)
- ▶▶ 3,4,5,7,9,10,11,12,14,15 Set3,4,5,7,9,10,11,12,14,15 to PCI2.

☞ PCI3 IRQ Assignment

- ▶▶ Auto Auto assign IRQ to PCI 3. (Default value)
- ▶▶ 3,4,5,7,9,10,11,12,14,15 Set3,4,5,7,9,10,11,12,14,15 to PCI3.

☞ PCI4 IRQ Assignment

- ▶▶ Auto Auto assign IRQ to PCI 4. (Default value)
- ▶▶ 3,4,5,7,9,10,11,12,14,15 Set3,4,5,7,9,10,11,12,14,15 to PCI4.

PC Health Status

CMOS Setup Utility - Copyright (C) 1984-2002 Award Software

PC Health Status

| | | |
|---|------------|-----------|
| Reset Case Open Status | [Disabled] | Item Help |
| Case Opened | No | MenuLevel |
| VCORE | 1.772V | |
| DDRVtt | 1.248V | |
| +3.3V | 3.280V | |
| +5V | 4.919 V | |
| +12V | 11.968V | |
| 5VSB | 5.053V | |
| Current System Temperature | 37°C | |
| Current CPU FAN Speed | 6250RPM | |
| Current SYSTEM FAN speed | 0RPM | |
| CPU FAN Fail Warning | [Disabled] | |
| SYSTEM FAN Fail Warning | [Disabled] | |
| CPU Shutdown Temperature | [Disabled] | |
| Current CPU Temperature | 52°C/125°F | |
| ↑↓→←: Move Enter: Select +/-/PU/PD: Value F10: Save ESC: Exit F1: General Help F5: Previous Values F6: Fail-Safe Defaults F7: Optimized Defaults | | |

Figure7: PC Health Status

☞ Reset Case Open Status

☞ Case Opened

If the case is closed, "Case Opened" will show "No".

If the case have been opened, "Case Opened" will show "Yes".

If you want to reset "Case Opened" value, set "Reset Case Open Status" to "Enabled" and save CMOS, your computer will restart.

☞ Current Voltage (V) VCORE/DDRVtt/ +3.3V/ +5V / +12V / 5VSB

Detect system's voltage status automatically.

☞ Current CPU FAN / SYSTEM FAN Speed (RPM)

Detect Fan speed status automatically.

☞ Fan Fail Warning (CPU / SYSTEM)

- ▶▶ Disabled Don't monitor current fan speed. (Default value)
- ▶▶ Enabled Alarm when stops.

☞ CPU Shutdown Temperature

- ▶▶ Enabled System shutdown when current CPU temperature over than 110°C
- ▶▶ Disabled Don't monitor current temperature. (Default value)

☞ Current CPU Temperature (°C)

Detect CPU Temp. automatically.

Frequency/Voltage Control

CMOS Setup Utility - Copyright (C) 1984-2002 Award Software

Frequency/Voltage Control

| | | |
|---|-----------|------------|
| Spread spectrum Modulated | [Auto] | Menu Level |
| CPU Host Clock Control | [Disable] | Item Help |
| ※CPU Host Frequency (MHz) | 100 | |
| ※PCI/AGP Frequency (MHz) | 33/66 | |
| DRAM Clock (MHz) | [Auto] | |
| AGP mode support | [Auto] | |
| CPU Voltage Control | [Auto] | |
| AGP OverVoltage Control | [Auto] | |
| DIMM OverVoltage Control | [Auto] | |
| ↑↓→←: Move Enter: Select +/-/PU/PD: Value F10: Save ESC: Exit F1: General Help F5: Previous Values F6: Fail-Safe Defaults F7: Optimized Defaults | | |

Figure 8: Frequency/Voltage Control

※ Those items will be available when "CPU Host Clock Control" is set to Enabled.

☞ Spread spectrum Modulated

- ▶▶ Auto Set clock spread spectrum by auto. (Default value)
- ▶▶ Disabled Disable clock spread spectrum.
- ▶▶ Enabled Enable clock spread spectrum.

☞ CPU Host Clock Control

Note: If system hangs up before enter CMOS setup utility, wait for 20 sec for times out reboot. When time out occur, system will reset and run at CPU default Host clock at next boot.

- ▶▶ Disable Disable CPU Host Clock Control. (Default value)
- ▶▶ Enable Enable CPU Host Clock Control.

☞ CPU Host Frequency (MHz) (By switch SW1)

- ▶▶ 100 Set CPU Host Clock to 100MHz~132MHz.
- ▶▶ 133 Set CPU Host Clock to 133MHz~165MHz.
- ▶▶ 166 Set CPU Host Clock to 166MHz~200MHz.

☞ PCI/AGP Frequency (MHz)

- ▶▶ The values depend on CPU Host Frequency (Mhz) .

☞ DRAM Clock (MHz)

- ⚠ Wrong frequency may make system can't boot. Clear CMOS to overcome wrong frequency issue.

- ▶▶ Please set DRAM Clock according to your requirement.

If you use DDR200 DRAM module, please set "DRAM Clock(MHz)" to "100-DDR200". If you use DDR333 DRAM module, please set "DRAM Clock(MHz)" to "166-DDR333".

Incorrect using it may cause your system broken. For power End-User use only!

- ▶▶ Auto Auto setting Memory frequency . (Default value)

☞ AGP mode support

- ▶▶ Auto Auto setting AGP transfer rate.(Default value)
- ▶▶ 8X Set AGP 8X mode support.
- ▶▶ 4X Set AGP 4X mode support.
- ▶▶ 2X Set AGP 2X mode support.
- ▶▶ 1X Set AGP 1X mode support.

- ⚠ An AGP 4X graphic card is only allowed to run at AGP4X mode, even it is set to AGP 8X mode.

☞ CPU OverVoltage Control

Increase CPU voltage may get stable for Over_Clock. But it may damage to CPU when enable this feature.

- ▶▶ Auto Supply voltage as CPU required. (Default value)
- ▶▶ +5% / +7.5% / +10% Increase voltage range as user selected.

☞ AGP OverVoltage Control

Increase AGP voltage may get stable for Over_Clock. But it may damage to AGP Card when enable this feature.

- ▶▶ Auto Supply voltage as AGP Card required. (Default value)
- ▶▶ +0.1V~+.03V Set AGP voltage from 1.6V~1.8V.

☞ DIMMOverVoltage Control

Increase DRAM voltage may get stable for Over_Clock. But it may damage to DRAM module when enable this feature.

- ▶▶ Auto Supply voltage as DRAM module required. (Default value)
- ▶▶ +0.1V~+.03V Set DIMM voltage from 2.6V~2.8V.

Top Performance

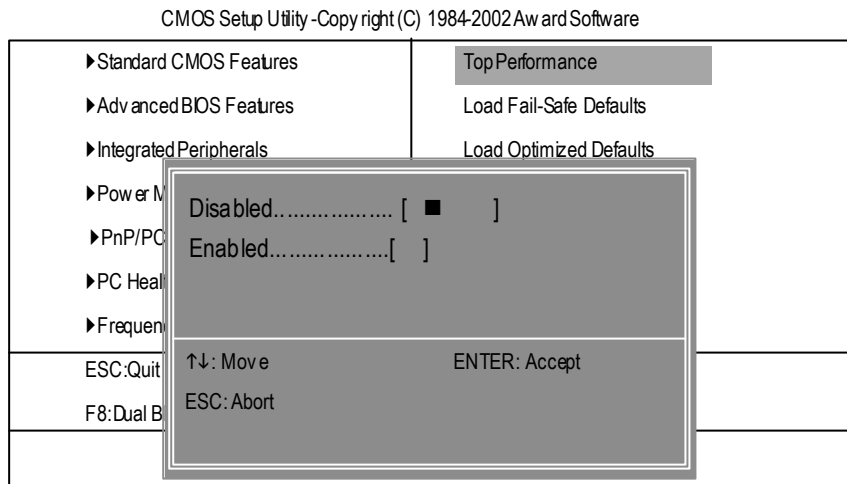

Figure 9: Top Performance

Top Performance

If you wish to maximize the performance of your system, set "Top Performance" as "Enabled".

- ▶▶ Disabled Disable this function. (Default Value)
- ▶▶ Enabled Enable Top Performance function.



You must check whether your RAM&CPU support over clock when you set "Top Performance" to "Enabled"

Load Fail-Safe Defaults

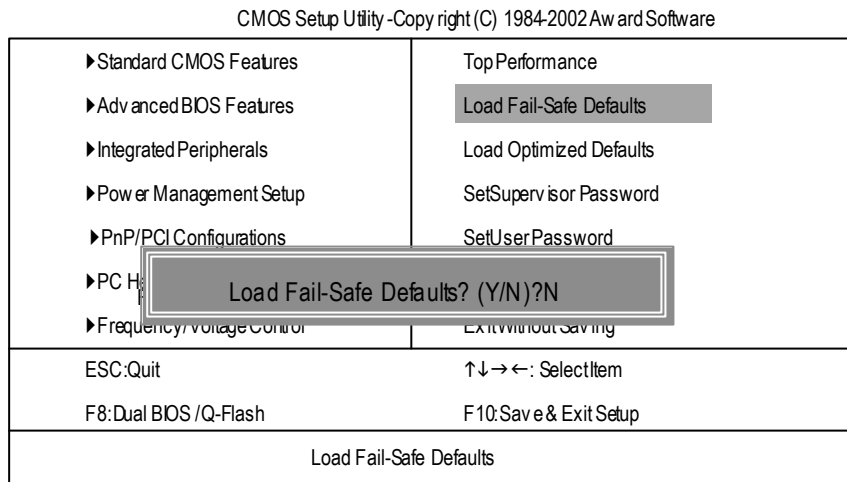

Figure 11: Load Fail-Safe Defaults

☞ Load Fail-Safe Defaults

Fail-Safe defaults contain the most appropriate values of the system parameters that allow minimum system performance.

Load Optimized Defaults

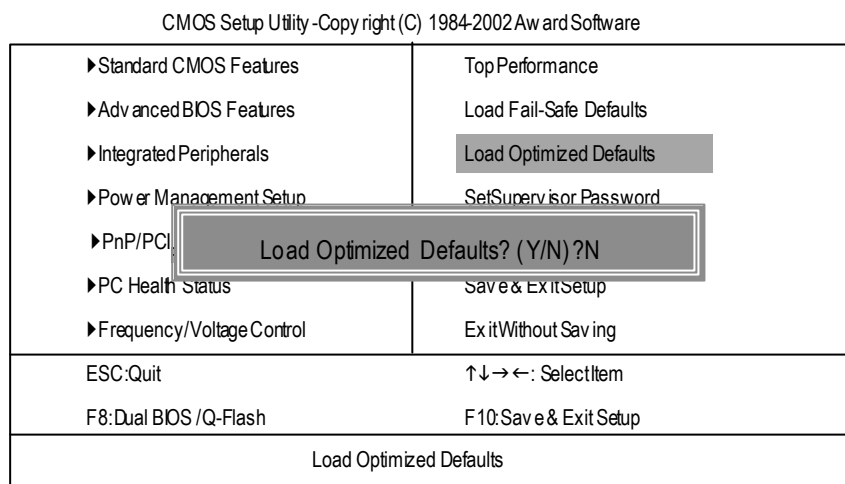

Figure 12: Load Optimized Defaults

Load Optimized Defaults

Selecting this field loads the factory defaults for BIOS and Chipset Features which the system automatically detects.

Set Supervisor/User Password

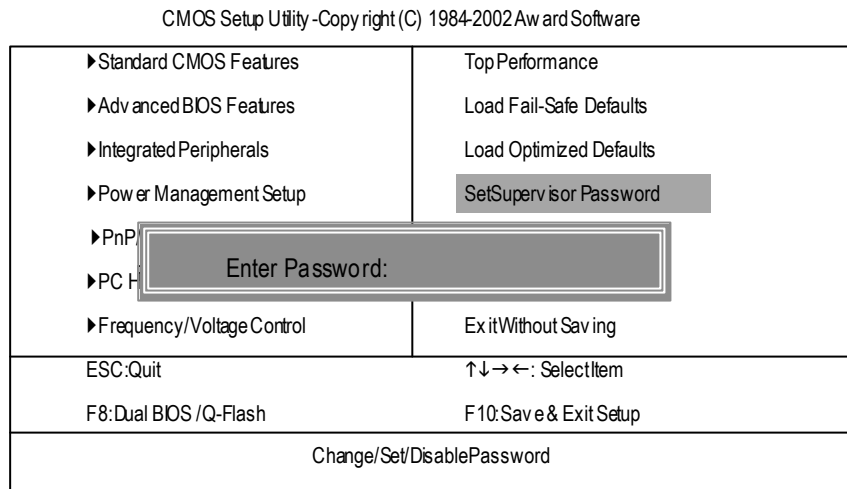

Figure 13: Password Setting

When you select this function, the following message will appear at the center of the screen to assist you in creating a password.

Type the password, up to eight characters, and press <Enter>. You will be asked to confirm the password. Type the password again and press <Enter>. You may also press <Esc> to abort the selection and not enter a password.

To disable password, just press <Enter> when you are prompted to enter password. A message "PASSWORD DISABLED" will appear to confirm the password being disabled. Once the password is disabled, the system will boot and you can enter Setup freely.

The BIOS Setup program allows you to specify two separate passwords: a SUPERVISOR PASSWORD and a USER PASSWORD. When disabled, anyone may access all BIOS Setup program function. When enabled, the Supervisor password is required for entering the BIOS Setup program and having full configuration fields, the User password is required to access only basic items.

If you select "System" at "Security Option" in Advance BIOS Features Menu, you will be prompted for the password every time the system is rebooted or any time you try to enter Setup Menu.

If you select "Setup" at "Security Option" in Advance BIOS Features Menu, you will be prompted only when you try to enter Setup.

Save & Exit Setup

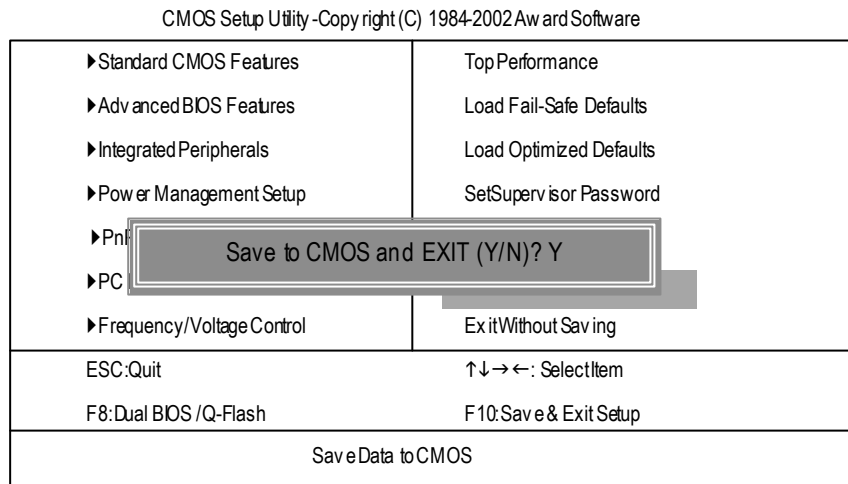

Figure 14: Save & Exit Setup

Type "Y" will quit the Setup Utility and save the user setup value to RTC CMOS.

Type "N" will return to Setup Utility.

Exit Without Saving

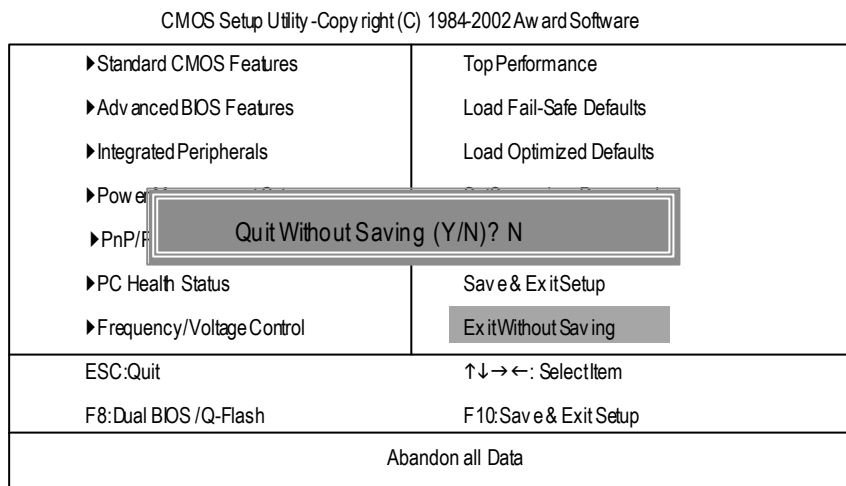

Figure 15: Exit Without Saving

Type "Y" will quit the Setup Utility without saving to RTC CMOS.

Type "N" will return to Setup Utility.

Chapter 4 Technical Reference

Block Diagram

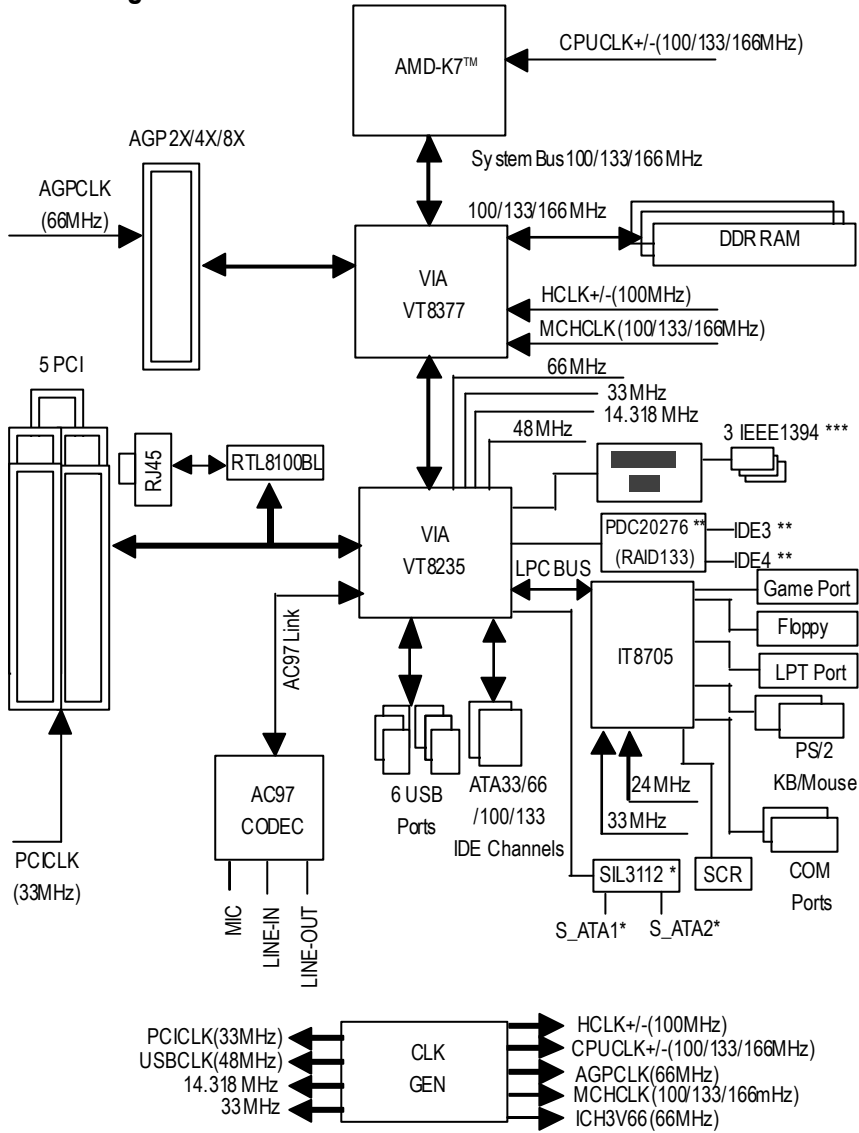

*** FOR GA-7VAXP Ultra Only.

*** FOR GA-7VAXP Ultra / GA-7VAXP Only.

*** For GA-7VAXP Ultra / GA-7VAXP / GA-7VAX1394 Only.

BIOS Flash Procedure



Method 1:

We use GA-7VTX motherboard and Flash841 BIOS flash utility as example.

Please flash the BIOS according to the following procedures if you are now under the DOS mode.

Flash BIOS Procedure:

STEP 1:

- (1) Please make sure your system has installed the extraction utility such as winzip or pkunzip.
Firstly you have to install the extraction utility such as winzip or pkunzip for unzip the files.
Both of these utilities are available on many shareware download pages like <http://www.cnet.com>

STEP 2: Make a DOS boot diskette. (See example: Windows 98 O.S.)

Beware: Windows ME/2000 are not allowed to make a DOS boot diskette.

- (1) With an available floppy disk in the floppy drive. Please leave the diskette "UN-write protected" type. Double click the "My Computer" icon from Desktop, then click "3.5 diskette (A)" and right click to select "Format (M)"

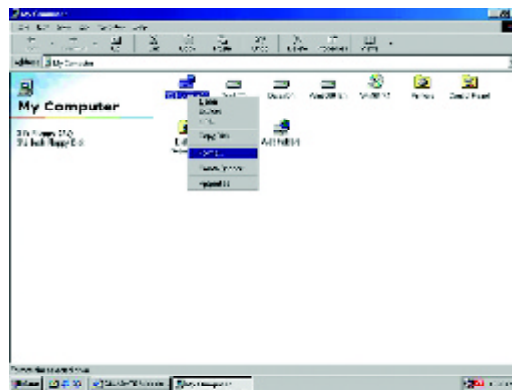

(2) Select the "Quick (erase)" for Format Type, and pick both "Display summary when finished" and "Copy system files", after that press "Start". That will format the floppy and transfer the needed system files to it.

Beware: This procedure will erase all the prior data on that floppy, so please proceed accordingly.

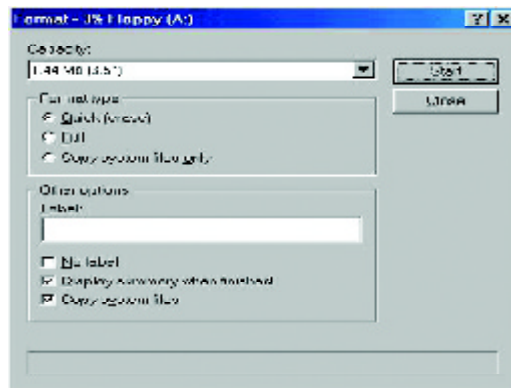

(3) After the floppy has been formatted completely, please press "Close".

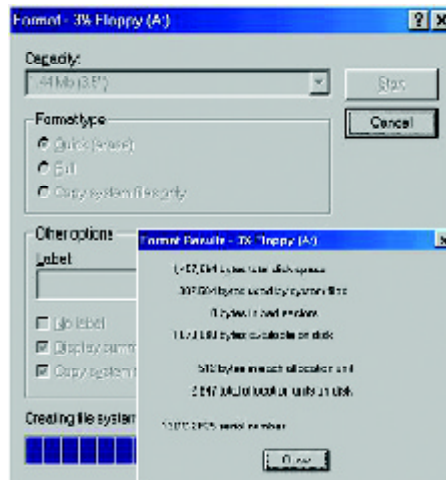

STEP 3: Download BIOS and BIOS utility program.

(1) Please go to Gigabyte website <http://www.gigabyte.com.tw/index.html>, and click "Support".



(2) From Support zone, click the "Motherboards BIOS & Drivers".

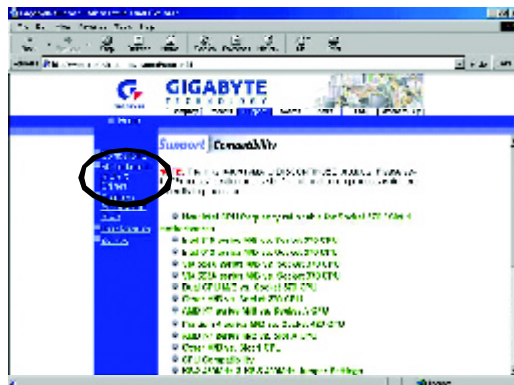

(3) We use GA-7V TX motherboard as example. Please select GA-7V TX by Model or Chipset optional menu to obtain BIOS flash files.

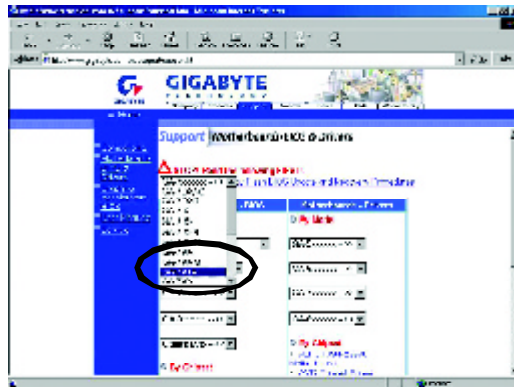

(4) Select an appropriate BIOS version (For example: F4), and click to download the file. It will pop up a file download screen, then select the "Open this file from its current location" and press "OK".

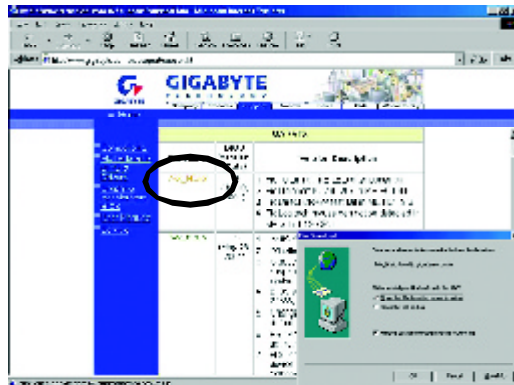

(5) At this time the screen shows the following picture, please click "Extract" button to unzip the files.

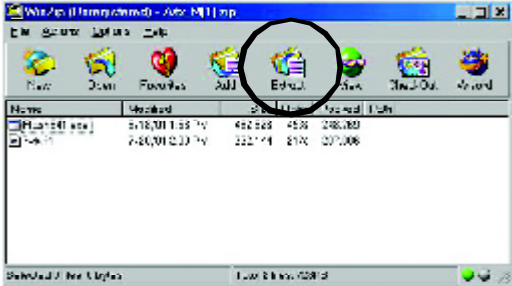

(6) Please extract the download files into the clean bootable floppy disk A mentioned in STEP 2, and press "Extract".

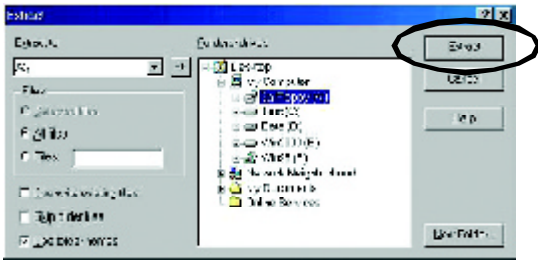

STEP 4: Make sure the system will boot from the floppy disk.

- (1) Insert the floppy disk (contains bootable program and unzip file) into the floppy drive A. Then, restart the system. The system will boot from the floppy disk. Please press key to enter BIOS setup main menu when system is boot up.



- (2) Once you enter the BIOS setup utility, the main menu will appear on the screen. Use the arrows to highlight the item "BIOS FEATURES SETUP".

| | |
|--|---|
| AMIBIOS SIMPLE SETUP UTILITY - VERSION 1.24b (C) 1999 American Megatrends, Inc. All Rights Reserved | |
| STANDARD CMOS SETUP BIOS FEATURES SETUP CHIPSET FEATURES SETUP POWER MANAGEMENT SETUP PNP / PC CONFIGURATION LOAD BIOS DEFAULTS LOAD SETUP DEFAULTS | INTEGRATED PERIPHERALS HARDWARE MONITOR & MISC SETUP SUPERVISOR PASSWORD USER PASSWORD IDE HDD AUTO DETECTION SAVE & EXIT SETUP EXIT WITHOUT SAVING |
| ESC: Quit ↑↓←→ : Select Item (Shift)F2 : Change Color F5: Old Values F6: Load BIOS Defaults F7: Load Setup Defaults F10: Save & Exit | |
| Time, Date , Hard Disk Type... | |

(3) Press "Enter" to enter "BIOS FEATURES SETUP" menu. Use the arrows to highlight the item "1st Boot Device", and then use the "Page Up" or "Page Down" keys to select "Floppy".

| AMIBIOS SETUP- BIOS FEATURES SETUP | |
|--|-----------------------------------|
| (C) 2001 American Megatrends, Inc. All Rights Reserved | |
| 1st Boot Device : Floppy | |
| 2nd Boot Device : IDE-0 | |
| 3rd Boot Device : CDROM | |
| S.M.A.R.T. for Hard Disks : Disabled | |
| BootUp Num-Lock : On | ESC: Quit ↑↓←→: Select Item |
| Floppy Drive Seek : Disabled | F1 : Help PU/PD/+/-: Modify |
| Password Check : Setup | F5 : Old Values (Shift) F2: Color |
| | F6 : Load BIOS Defaults |
| | F7 : Load Setup Defaults |

(4) Press "ESC" to go back to previous screen. Use the arrows to highlight the item "SAVE & EXIT SETUP" then press "Enter". System will ask "SAVE to CMOS and EXIT (Y/N)?" Press "Y" and "Enter" keys to confirm. Now the system will reboot automatically, the new BIOS setting will be taken effect next boot-up.

| AMIBIOS SIMPLE SETUP UTILITY - VERSION 1.24b | |
|---|-------------------------------|
| (C) 2001 American Megatrends, Inc. All Rights Reserved | |
| STANDARD CMOS SETUP | INTEGRATED PERIPHERALS |
| BIOS FEATURES SETUP | HARDWARE MONITOR & MISC SETUP |
| CHIPSET FEATURES SETUP | SUPERVISOR PASSWORD |
| POWER MANAGEMENT SETUP | USER PASSWORD |
| PNP/PCICONFIG | SAVE & EXIT SETUP |
| LOAD BIOS DEFAULTS | EXIT WITHOUT SAVING |
| LOAD SETUP DEFAULTS | |
| ESC: Quit ↑↓←→ : Select Item (Shift)F2 : Change Color F5: Old Values | |
| F6: Load BIOS Defaults F7: Load Setup Defaults F10: Save & Exit | |
| Save Data to CMOS & Exit SETUP | |

STEP 5: BIOS flashing.

- (1) After the system boot from floppy disk, type "A:\> dir/w" and press "Enter" to check the entire files in floppy A. Then type the "BIOS flash utility" and "BIOS file" after A:\>. In this case you have to type "A:\> Flash841 7VTX.F4" and then press "Enter".

```
Starting Windows 98...

Microsoft(R) Windows 98
  © Copyright Microsoft Corp 1981-1999

A:\> dir/w
  Volume in drive A has no label
  Volume Serial Number is 16EB-353D
  Directory of A:\
COMMAND.COM  7VTX.F4  FLASH841.EXE
             3 file(s)  838,954 bytes
             0 dir(s)   324,608 bytes free

A:\> Flash841 7VTX.F4
```

- (2) Now screen appears the following Flash Utility main menu. Press "Enter", the highlighted item will locate on the model name of the right-upper screen. Right after that, press "Enter" to start BIOS Flash Utility.

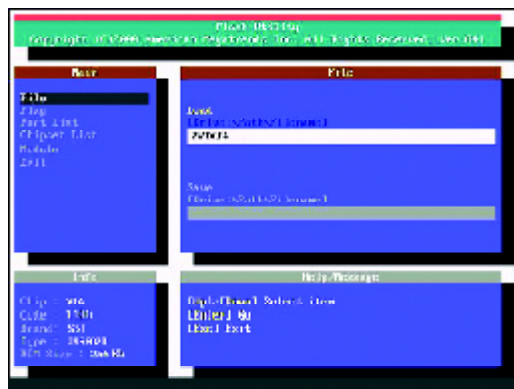

(3) It will pop up a screen and asks "Are you sure to flash the BIOS?" Press [Enter] to continue the procedure, or press [ESC] to quit.

Beware: Please do not turn off the system while you are upgrading BIOS. It will render your BIOS corrupted and system totally inoperative.

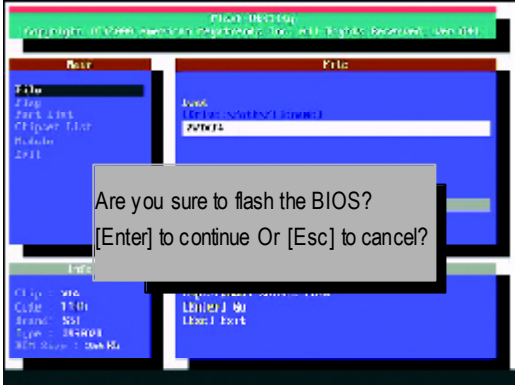

(4) The BIOS flash completed. Please press [ESC] to exit Flash Utility.

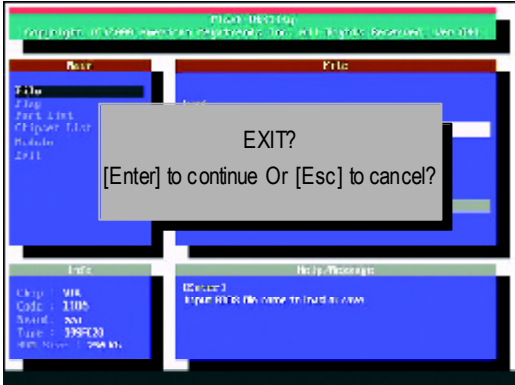

STEP 6: Load BIOS defaults.

Normally the system redetects all devices after BIOS has been upgraded. Therefore, we highly recommend reloading the BIOS defaults after BIOS has been upgraded. This important step resets everything after the flash.

- (1) Take out the floppy diskette from floppy drive, and then restart the system. The boot up screen will indicate your motherboard model and current BIOS version.

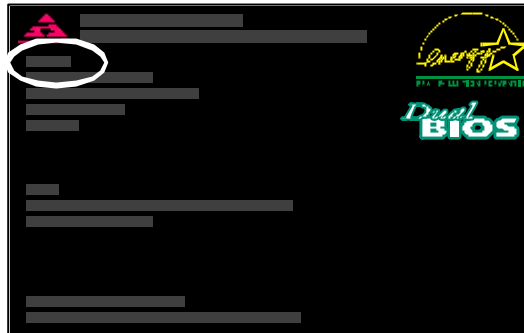

- (2) Don't forget to press key to enter BIOS setup again when system is boot up. Use the arrows to highlight the item "LOAD SETUP DE FAULTS" then press "Enter". System will ask "Load Setup Defaults (Y/N)?" Press "Y" and "Enter" keys to confirm.

| | |
|---|-------------------------------|
| AMIBIOS SIMPLE SETUP UTILITY - VERSION 1.24b (C)2001 American Megatrends, Inc. All Rights Reserved | |
| STANDARD CMOS SETUP | INTEGRATED PERIPHERALS |
| BIOS FEATURES SETUP | HARDWARE MONITOR & MISC SETUP |
| CHIPSET FEATURES SETUP | SUPERVISOR PASSWORD |
| POWER MANAGEMENT SETUP | MOUSE BATTERY |
| PNP/PCICONFIG | Load Setup Defaults? (Y/N)?N |
| LOAD BIOS DEFAULTS | SAVE & EXIT SETUP |
| LOAD SETUP DEFAULTS | EXIT WITHOUT SAVING |
| ESC: Quit ↑↓←→ : Select Item (Shift)F2: Change Color F5: Old Values F6: Load BIOS Defaults F7: Load Setup Defaults F10: Save & Exit | |
| Load Setup Defaults | |

(3) Use the arrows to highlight the item "SAVE & EXIT SETUP" and press "Enter". System will ask "SAVE to CMOS and EXIT (Y/N)?" Press "Y" and "Enter" keys to confirm. Now the system will reboot automatically, the new BIOS setting will be taken effect next boot-up.

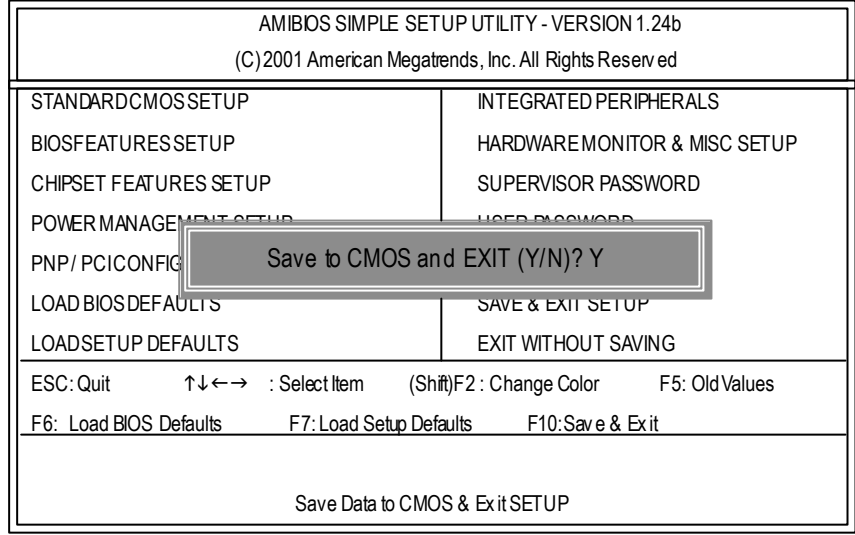

(4) Congratulate you have accomplished the BIOS flash procedure.

Method 2:

Dual BIOS / Q-Flash Introduction

A. What is Dual BIOS Technology?

Dual BIOS means that there are two system BIOS (ROM) on the motherboard, one is the Main BIOS and the other is Backup BIOS. Under the normal circumstances, the system works on the Main BIOS. If the Main BIOS is corrupted or damaged, the Backup BIOS can take over while the system is powered on. This means that your PC will still be able to run stably as if nothing has happened in your BIOS.

B. How to use Dual BIOS and Q-Flash Utility?

a. After power on the computer, pressing immediately during POST (Power On Self Test) it will allow you to enter Award BIOS CMOS SETUP, then press <F8> to enter Flash utility.

CMOS Setup Utility - Copyright (C) 1984-2002 Award Software

| | |
|-------------------------------|--|
| ▶Standard CMOS Features | Top Performance |
| ▶Advanced BIOS Features | Load Fail-Safe Defaults |
| ▶Integrated Peripherals | Load Optimized Defaults |
| ▶Power Management Setup | Set Supervisor Password |
| ▶PnP/PCI | Enter Dual BIOS / Q-Flash Utility (Y/N)? Y |
| ▶PC Health | |
| ▶Frequency/Voltage Control | Exit Without Saving |
| ESC:Quit | ↑↓→←: Select Item |
| F8:Dual BIOS /Q-Flash | F10:Save & Exit Setup |
| Time, Date, Hard Disk Type... | |

b. Dual BIOS / Q-Flash Utility

| Dual BIOS Utility V1.30 | | |
|--------------------------------|--------------|---------------------------|
| Boot From..... | Main Bios | |
| Main ROM Type/Size..... | SST 49LF003A | 512K |
| Backup ROM Type/Size..... | SST 49LF003A | 512K |
| Wide Range Protection | Disable | |
| Boot From | Main Bios | |
| Auto Recovery | Enable | |
| Halt On Error | Disable | |
| Keep DMI Data | Enable | |
| Copy Main ROM Data to Backup | | |
| Load Default Settings | | |
| Save Settings to CMOS | | |
| Q-Flash Utility | | |
| Update Main BIOS from Floppy | | |
| Update Backup BIOS from Floppy | | |
| Save Main BIOS to Floppy | | |
| Save Backup BIOS to Floppy | | |
| PgDn/PgUp: Modify | ↑↓: Move | ESC: Reset F10: Power Off |

3.) Dual BIOS Item explanation:

- **Wide Range Protection: Disable(Default), Enable**

Status 1:

If any failure (ex. Update ESCD failure, checksum error or reset...) occurs in the Main BIOS, just before the Operating System is loaded and after the power is on, and that the Wide Range Protection is set to "Enable", the PC will boot from Backup BIOS automatically.

Status 2:

If the ROM BIOS on peripherals cards(ex. SCSI Cards, LAN Cards,..) emits signals to request restart of the system after the user make any alteration on it, the boot up BIOS will not be changed to the Backup BIOS.

- **Boot From : Main BIOS(Default), Backup BIOS**

Status 1:

The user can set to boot from main BIOS or Backup BIOS.

Status 2:

If one of the main BIOS or the Backup BIOS fails, this item "Boot From : Main BIOS(Default)" will become gray and will not be changed by user.

- **Auto Recovery : Enable(Default), Disable**

When one of the Main BIOS or Backup BIOS occurs checksum failure, the working BIOS will automatically recover the BIOS of checksum failure.

(In the Power Management Setup of the BIOS Setting, if ACPI Suspend Type is set to Suspend to RAM, the Auto Recovery will be set to Enable automatically.)

(If you want to enter the BIOS setting, please press "Del" key when the boot screen appears.)

- **Halt On Error : Disable(Default), Enable**

If the BIOS occurs a checksum error or the Main BIOS occurs a WIDE RANGE PROTECTION error and Halt On Error set to Enable, the PC will show messages on the boot screen, and the system will pause and wait for the user's instruction.

If Auto Recovery :Disable, it will show <or the other key to continue.>

If Auto Recovery :Enable, it will show <or the other key to Auto Recover.>

- **Keep DMI Data : Enable(Default), Disable**

Enable: The DMI data won't be replaced by flashing new BIOS.(recommend)

Disable: The DMI data will be replaced by flashing new BIOS.

- **Copy Main ROM Data to Backup**

(If you boot from Backup ROM, this item will change to "Copy Backup ROM Data to Main)

Auto recovery message:

BIOS Recovery: Main to Backup

The means that the Main BIOS works normally and could automatically recover the Backup BIOS.

BIOS Recovery: Backup to Main

The means that the Backup BIOS works normally and could automatically recover the Main BIOS. (This auto recovery utility is set by system automatically and can't be changed by user.)

- **Load Default Settings**

Load dual BIOS default value.

- **Save Settings to CMOS**

Save revised setting.

Save Main BIOS to Floppy / Save Backup BIOS to Floppy

In the A:drive, insert the floppy disk, then Press Enter to Run.

TYPE FILE NAME

File name: XXXX.XX

Total Size: 1.39M Free Size: 1.39M

F5: Refresh DEL: Delete

To name the file.

Congratulate you have accomplished the saving.

CONTROL KEYS

| | |
|-------------|-----------------------|
| <PgDn/PgUp> | Make changes |
| <↑> | Move to previous item |
| <↓> | Move to next item |
| <Enter> | Run |
| <Esc> | Reset |
| <F10> | Power Off |



DualBIOS™ Technology FAQ

GIGABYTE Technology is pleased to introduce DualBIOS technology, a hot spare for your system BIOS. This new est "Value-added" feature, in a long series of innovations from GIGABYTE, is available on GA-60XET Series motherboard. Future GIGABYTE motherboards will also incorporate this innovation.

What'sDualBIOS™?

On GIGABYTE motherboards w6ith DualBIOS there are physically two BIOS chips. For simplicity we'll call one your "Main BIOS" and the other we'll call your "Backup" BIOS (your "hot spare"). If your Main BIOS fails, the Backup BIOS almost automatically takes over on your next system boot. Almost automatically and with virtually zero down time! Whether the problem is a failure in flashing y our BIOS or a virus or a catastrophic failure of the Main BIOS chip, the result is the same - the Backup BIOS backs you up, almost automatically.

I. Q: What is DualBIOS™ technology?**Answer:**

DualBIOS technology is a patented technology from Giga-Byte Technology. The concept of this technology is based on the redundancy and fault tolerance theory. DualBIOS™ technology simply means there are two system BIOSes (ROM) integrated onto the motherboard. One is a main BIOS, and the other is a backup BIOS. The mainboard will operate normally with the main BIOS, however, if the main BIOS is corrupt or damaged for various reasons, the backup BIOS will be automatically used when the system powered-On. Your PC will operate as before the main BIOS was damaged, and is completely transparent to the user.

II. Q: Why does anyone need a motherboard with DualBIOS™ technology?**Answer:**

In today's systems there are more and more BIOS failures. The most common reasons are virus attacks, BIOS upgrade failures, and/or deterioration of the BIOS (ROM) chip itself.

1. New computer viruses are being found that attack and destroy the system BIOS. They may corrupt your BIOS code, causing your PC to be unstable or even not boot normally.
2. BIOS data will be corrupted if a power loss/surge occurs, or if a user resets the system, or if the power button is pressed during the process of performing a system BIOS upgrade.
3. If a user mistakenly updates their mainboard with the incorrect BIOS file, then the system may not be able to boot correctly. This may cause the PC system hang in operation or during boot.
4. A flash ROM's life cycle is limited according to electronic characteristics. The modern PC utilizes the Plug and Play BIOS, and is updated regularly. If a user changes peripherals often, there is a slight chance of damage to the flash ROM. With Giga-Byte Technology's patented DualBIOS™ technology you can reduce the possibility of hangs during system boot up, and/or loss BIOS data due to above reasons. This new technology will eliminate valuable system down time and costly repair bills cause by BIOS failures.

III. Q: How does DualBIOS™ technology work?**Answer:**

1. DualBIOS™ technology provides a wide range of protection during the boot up procedure. It protects your BIOS during system POST, ESCD update, and even all the way to PNP detection/assignment.
2. DualBIOS™ provides automatic recovery for the BIOS. When the first BIOS used during boot up does not complete or if a BIOS checksum error occurs, boot-up is still possible. In the DualBIOS™ utility, the "Auto Recovery" option will guarantee that if either the main BIOS or backup BIOS is corrupted, the DualBIOS™ technology will use the good BIOS and correct the wrong BIOS automatically.
3. DualBIOS™ provides manual recovery for the BIOS. DualBIOS™ technology contains a built-in flash utility, which can flash your system BIOS from backup to main and/or visa versa. There is no need for an OS-dependent flash utility program.
4. DualBIOS™ contains a one-way flash utility. The built-in one-way flash utility will ensure that the corrupt BIOS is not mistaken as the good BIOS during recovery and that the correct BIOS (main vs. backup) will be flashed. This will prevent the good BIOS from being flashed.

IV. Q: Who Needs DualBIOS™ technology?**Answer:**

1. Every user should have DualBIOS™ technology due to the advancement of computer viruses.

Everyday, there are new BIOS-type viruses discovered that will destroy your system BIOS. Most commercial products on the market do not have solutions to guard against this type of virus intrusion. The DualBIOS™ technology will provide a state-of-the-art solution to protect your PC:

Case I.) Vicious computer viruses may wipe out your entire system BIOS. With a conventional single system BIOS PC, the PC will not be functional until it is sent for repairs.

Case II.) If the "Auto Recovery" option is enabled in the DualBIOS™ utility, and if a virus corrupts your system BIOS, the backup BIOS will automatically reboot the system and correct the main BIOS.

Case III.) A user may override booting from the main system BIOS. The DualBIOS™

utility may be entered to manually change the boot sequence to boot from the backup BIOS.

2. During or after a BIOS upgrade, if DualBIOS™ detects that the main BIOS is corrupt, the backup BIOS will take over the boot-up process automatically. Moreover, it will verify the main and backup BIOS checksums when booting-up. DualBIOS™ technology examines the checksum of the main and backup BIOS while the system is powered on to guarantee your BIOS operates properly.
3. Power Users will have the advantage of having two BIOS versions on their mainboard. The benefit is being able to select either version BIOS to suit the performance system needs.
4. Flexibility for high-end desktop PCs and workstation/servers. In the DualBIOS™ utility, the option can be set, "Halt On When BIOS Defects," to be enabled to halt your system with a warning message that the main BIOS has been corrupted. Most workstation/servers require constant operation to guarantee services have not been interrupted. In this situation, the "Halt On When BIOS Defects" message may be disabled to avoid system pauses during normal booting. Another advantage you gain from Giga-Byte's DualBIOS™ technology is the ability to upgrade from dual 2 Mbit BIOS to dual 4 Mbit BIOS in the future if extra BIOS storage is needed.

Method 3:

If you don't have DOS boot disk, we recommend that you used Gigabyte @BIOS™ program to flash BIOS.



(1)



(2)



(3)



(4)

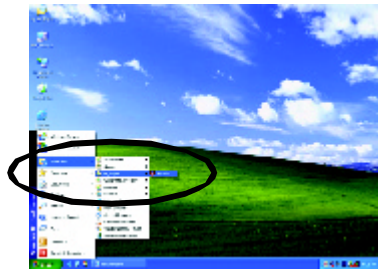

(5)

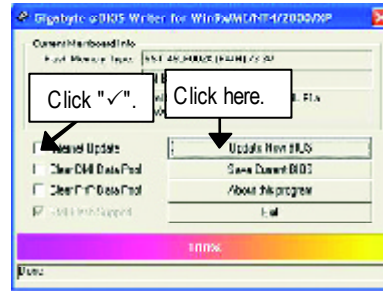

(6)

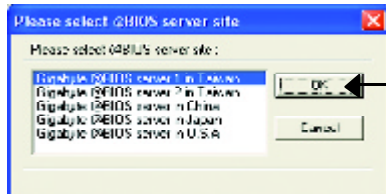

(7)

5. Please select @BIOS sever site, then Click "OK".

Methods and steps:

I. Update BIOS through Internet

- a. Click "Internet Update" icon
- b. Click "Update New BIOS" icon
- c. Select @BIOS™ sever
- d. Select the exact model name on your motherboard
- e. System will automatically download and update the BIOS.

II. Update BIOS NOT through Internet:

- a. Do not click "Internet Update" icon
- b. Click "Update New BIOS"
- c. Please select "All Files" in dialog box while opening the old file.
- d. Please search for BIOS unzip file, downloading from internet or any other methods (such as: **7VAXPU.F1**).
- e. Complete update process following the instruction.

III. Save BIOS

In the very beginning, there is "Save Current BIOS" icon shown in dialog box. It means to save the current BIOS version.

IV. Check out supported motherboard and Flash ROM:

In the very beginning, there is "About this program" icon shown in dialog box. It can help you check out which kind of motherboard and which brand of Flash ROM are supported.

Note:

- a. In method I, if it shows two or more motherboard's model names to be selected, please make sure your motherboard's model name again. Selecting wrong model name will cause the system unbooted.
- b. In method II, be sure that motherboard's model name in BIOS unzip file are the same as your motherboard's. Otherwise, your system won't boot.
- c. In method I, if the BIOS file you need cannot be found in @BIOS™ server, please go onto Gigabyte's web site for downloading and updating it according to method II.
- d. Please note that any interruption during updating will cause system unbooted

@ BIOS Introduction

Gigabyte announces @BIOS Windows BIOS live update utility



Have you ever updated BIOS by yourself? Or like many other people, you just know what BIOS is, but always hesitate to update it? Because you think updating newest BIOS is unnecessary and actually you don't know how to update it.

Maybe not like others, you are very experienced in BIOS updating and spend quite a lot of time to do it. But of course you don't like to do it too much. First, download different BIOS from website and then switch the operating system to DOS mode. Secondly, use different flash utility to update BIOS. The above process is not a interesting job. Besides, always be carefully to store the BIOS source code correctly in your disks as if you update the wrong BIOS, it will be a nightmare.

Certainly, you wonder why motherboard vendors could not just do something right to save your time and effort and save you from the lousy BIOS updating work? Here it comes! Now Gigabyte announces @BIOS—the first Windows BIOS live update utility. This is a smart BIOS update software. It could help you to download the BIOS from internet and update it. Not like the other BIOS update software, it's a Windows utility. With the help of '@BIOS', BIOS updating is no more than a click.

Besides, no matter which mainboard you are using, if it's a Gigabyte's product*, @BIOS help you to maintain the BIOS. This utility could detect your correct mainboard model and help you to choose the BIOS accordingly. It then downloads the BIOS from the nearest Gigabyte ftp site automatically. There are several different choices; you could use "Internet Update" to download and update your BIOS directly. Or you may want to keep a backup for your current BIOS, just choose "Save Current BIOS" to save it first. You make a wise choice to use Gigabyte, and @BIOS update your BIOS smartly. You are now worry free from updating wrong BIOS, and capable to maintain and manage your BIOS easily. Again, Gigabyte's innovative product erects a milestone in mainboard industries.

For such a wonderful software, how much it costs? Impossible! It's free! Now, if you buy a Gigabyte's motherboard, you could find this amazing software in the attached driver CD. But please remember, connected to internet at first, then you could have a internet BIOS update from your Gigabyte @BIOS.

Easy Tune™ 4 Introduction

Gigabyte announces *EasyTune™ 4* Windows based Overclocking utility

EasyTune 4 carries on the heritage so as to pave the way for future generations.

Overclock" might be one of the most common issues in computer field. But have many users ever tried it? The answer is probably "no". Because "Overclock" is thought to be very difficult and includes a lot of technical know-how, sometimes "Overclock" is even considered as special skills found only in some enthusiasts. But as to the experts in "Overclock", what's the truth? They may spend quite a lot of time and money to study, try and use many different hardware or BIOS tools to do "Overclock". And even with these technologies, they still learn that it's quite a risk because the safety



and stability of an "Overclock" system is unknown. Now every thing is different because of a Windows based overclocking utility "EasyTune 4" --announced by Gigabyte. This windows based utility has totally changed the gaming rule of "Overclock". This is the first windows based overclocking utility is suitable for both normal and power users. Users can choose either "Easy Mode" or "Advanced Mode" for overclocking at their convenience. For users who choose "Easy Mode", they just need to click "Auto Optimize" to have autoed and immediate CPU overlocking. This software will then overdrive CPU speed automatically with the result being shown in the control panel. If users prefer "Overclock" by them, there is also another choice. Click "Advanced Mode" to enjoy "sport drive" class Overclocking user interface. "Advanced Mode", allows users to change the system bus / AGP / Memory working frequency in small increments to get ultimate system performance. It operates in coordination with Gigabyte motherboards. Besides, it is different from other traditional overlocking methods, EasyTune 4 doesn't require users to change neither BIOS nor hardware switch/jumper setting; on the other hand, they can do "Overclock" at easy step. Therefore, this is a safer way for "Overclock" as nothing is changed on software or hardware. If user runs EasyTune 4 over system's limitation, the biggest lost is only to restart the computer again and the side effect is then well controlled. Moreover, if one well-performed system speed has been tested in EasyTune 4, user can "Save" this setting and "Load" it in next time. Obviously, Gigabyte EasyTune 4 has already turned the "Overclock" technology toward to a newer generation. This wonderful software is now free bundled in Gigabyte motherboard attached in driver CD. Users may make a test drive of "EasyTune 4" to find out more amazing features by themselves.

*Some Gigabyte products are not fully supported by EasyTune 4. Please find the products supported list in the web site.

*Any "Overclocking action" is at user's risk, Gigabyte Technology will not be responsible for any damage or instability to your processor, motherboard, or any other components.

2-/4-/6-Channel Audio Function Introduction

The installation of windows 98SE/2K/ME/XP is very simple. Please follow next step to install the function!

Stereo Speakers Connection and Settings:

We recommend that you use the speaker with amplifier to acquire the best sound effect if the stereo output is applied.

STEP 1:

Connect the stereo speakers or earphone to "Line Out".

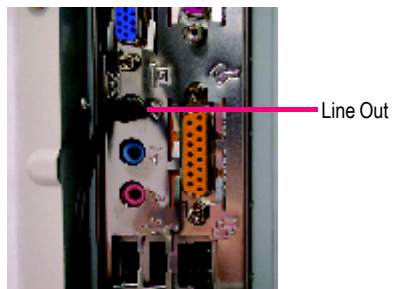

STEP 2:

After installation of the audio driver, you'll find an  icon on the taskbar's status area. Click the audio icon "Sound Effect" from the windows tray at the bottom of the screen.



STEP 3:

Select "Speaker Configuration", and choose the "2 channels for stereo speakers output".



4 Channel Analog Audio Output Mode

STEP 1 :

Connect the front channels to "Line Out", the rear channels to "Line In".

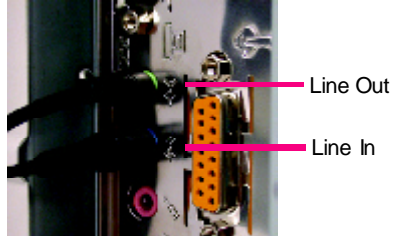

STEP 2 :

After installation of the audio driver, you'll find an  icon on the taskbar's status area. Click the audio icon "Sound Effect" from the windows tray at the bottom of the screen.



STEP 3 :

Select "Speaker Configuration", and choose the "4 channels for 4 speakers output". Disable "Only SURROUND-KIT", and press "OK".

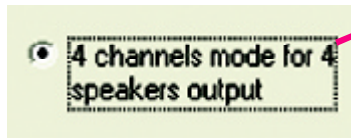

When the "Environment settings" is "None", the sound would be performed as stereo mode (2 channels output). Please select the other settings for 4 channels output.

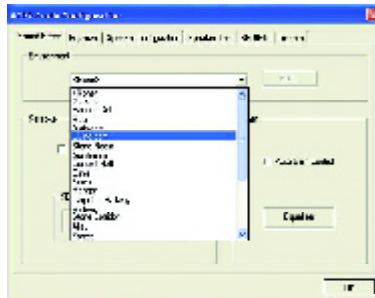

4 Channel Analog Audio Output Mode

STEP 1 :

Connect the front channels to "Line Out", the rear channels to "Line In".

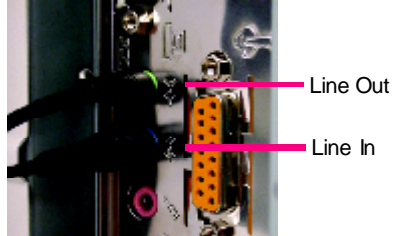

STEP 2:

After installation of the audio driver, you'll find an  icon on the taskbar's status area. Click the audio icon "Sound Effect" from the windows tray at the bottom of the screen.

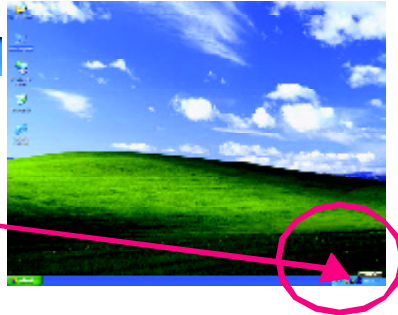

STEP 3:

Select "Speaker Configuration", and choose the "4 channels for 4 speakers output". Disable "Only SURROUND-KIT", and press "OK".

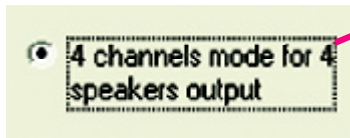

When the "Environment settings" is "None", the sound would be performed as stereo mode (2 channels output). Please select the other settings for 4 channels output.

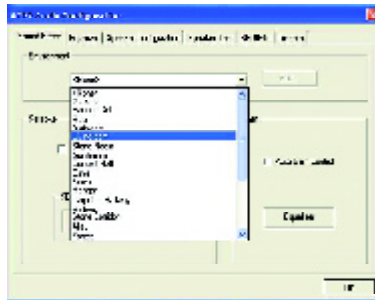

Advanced 6 Channel Analog Audio Output Mode (using Audio Combo Kit,Optional Device):

(Audio Combo Kit provides SPDIF output port : optical & coaxis and SURROUND-KIT : Rear R/L & Center/subwoofer)

SURROUND-KIT access analog output to rear channels and Center/Subwoofer channels. It is the best solution if you need 6 channel output, Line In and MIC at the same time. "SURROUND-KIT" is included in the GIGABYTE unique "Audio Combo Kit" as picture.

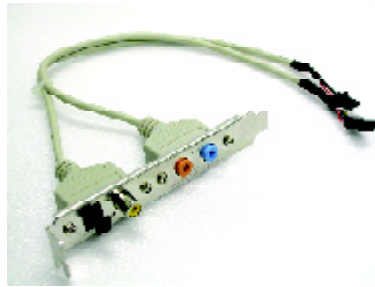

STEP 1 :

Insert the "Audio Combo Kit" in the back of the case , and fix it with the screw .



STEP 2 :

Connect the "SURROUND-KIT" to SUR_CEN on the M/B.

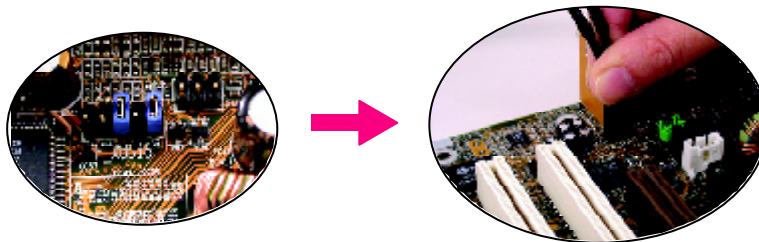

STEP3:

Connect the front channels to back audio panel's "Line Out", the rear channels to SURROUND-KIT's REAR R/L, and the Center/Subwoofer channels to SURROUND-KIT's SUBCENTER.



STEP4:

Click the audio icon "Sound Effect" from the windows tray at the bottom of the screen.



STEP5:

Select "Speaker Configuration", and choose the "6 channels for 5.1 speakers output".

Enable "Only SURROUND-KIT" and press "OK".

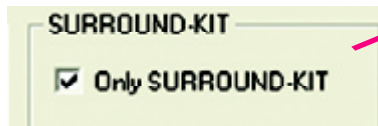

Basic & Advanced 6 Channel Analog Audio Output ModeNotes:

When the "Environment settings" is "None", the sound would be performed as stereo mode(2 channels output). Please select the other settings for 6 channels output.

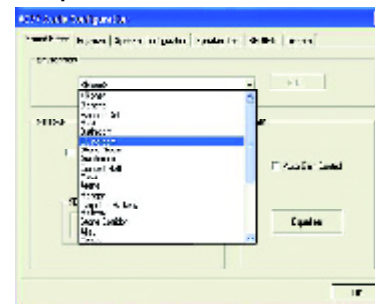

SPDIF Output Device (Optional Device)

A “SPDIF output” device is available on the motherboard. Cable with rear bracket is provided and could link to the “SPDIF output” connector (As picture.) For the further linkage to decoder, rear bracket provides coaxial cable and Fiber connecting port.

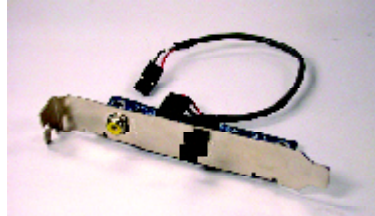

1. Connect the SPDIF output device to the rear bracket of PC, and fix it with screw.



2. Connect SPDIF wire to the motherboard.

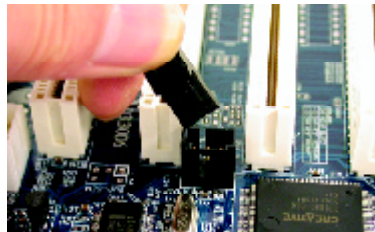

3. Connect co-axial or optical output to the SPDIF decoder.



English

Chapter 5 Appendix

Picture below are shown in Windows XP (CD driver version 1.2)

Insert the driver CD-title that came with your motherboard into your CD-ROM driver, the driver CD-title will auto start and show the installation guide. If not please double click the CD-ROM device icon in "My computer", and execute the setup.exe.

A. Installing VIAKT400 Chipset Driver

Please install this driver as the first priority. this item installs the chipset driver utility that enables Plug-n-Plug INF support for Intel chipset component.

B. Installing Sound Driver

Click this item to install sound driver.

C. Installing LAN Driver

Click this item to install LAN driver.



Appendix A: VIA 4 in 1 Service Pack Driver Installation

A. VIA 4 in 1 Service Pack Driver Utility:



(1)

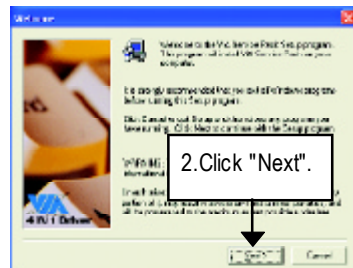

(2)

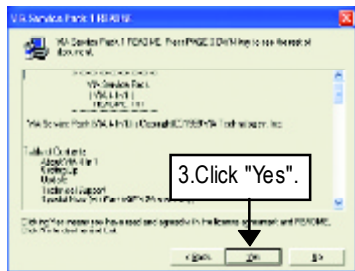

(3)



(4)



(5)



(6)



(7)

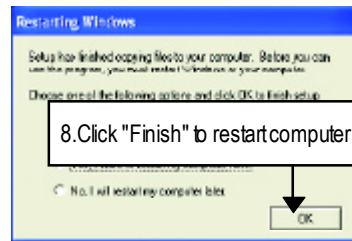

(8)

B. USB Path Driver:

Enable S3 for USB Device Setup is preparing the InstallShield(R) Wizard which will guide you through the setup process.

C. VIA USB2.0 Driver



(1)

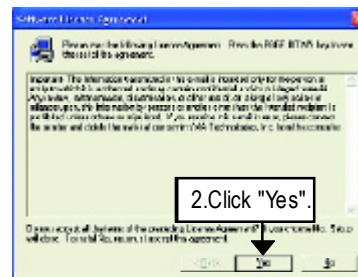

(2)



(3)



(4)

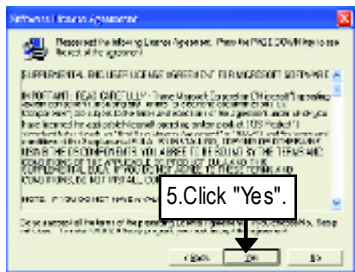

(5)

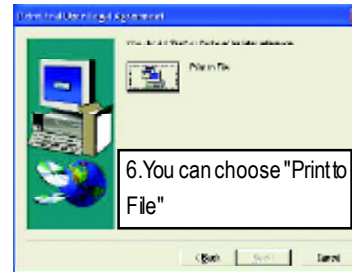

(6)



(7)

Print to File : Press this button, you can view file on the screen . We recommend you do it



If there is any problem occurred during USB2.0 device installing, using or upgrading. Please visit Microsoft or GIGABYTE website for downloading the latest drivers.

D.Other Device Driver

D-1:Silicon Image Sil3112 SATARaid Driver Install *



(1)



(2)



(3)

D-2:Silicon Image Sil3112 SATARaid Driver Utility Install *



Please do not install "Silicon Image SIL3112 SATARaid Driver Utility" under WIN98 or WIN ME if there is no Serial ATA Device.

For top performance and compatibility, it is recommend to use the SATA daughter Card which has Silicon Image Chipset.



(1)



(2)

*** FOR GA-7VAXP Ultra Only.

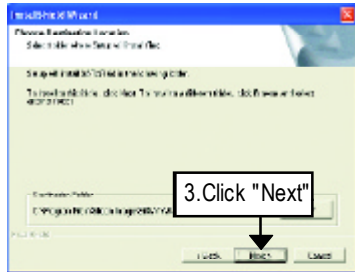

(3)

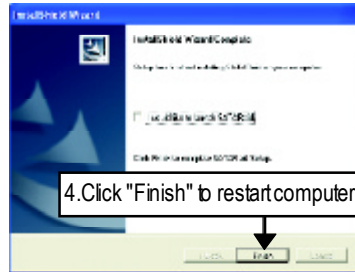

(4)

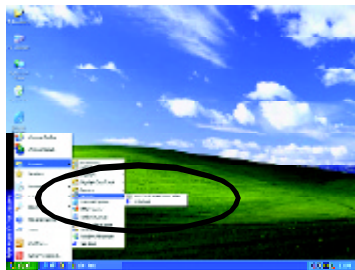

(5)

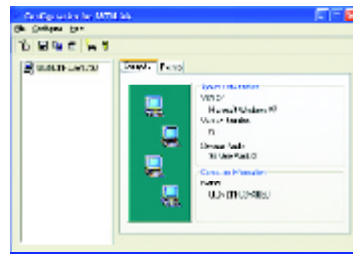

(6)

D-3: Promise RAID Driver Installation (BIOS Default Value :ATA, If you want to use RAID function, please change “Integrated Peripherals-RAID Controller Function “ to “RAID”) **

➤ For your reference, you can use the following steps to complete the Promise RAID Driver Installation.



(1)



(2)

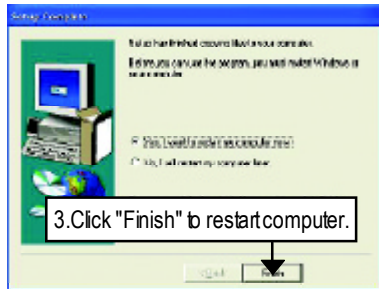

(3)

D-4: FastTrak Utilities Installation **



(1)



(2)

**** FOR GA-7VAXP / GA-7VAXP Ultra Only.**

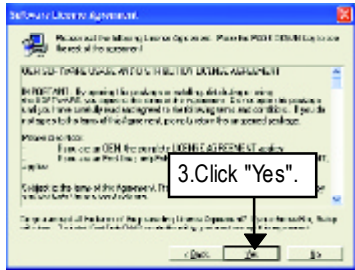

(3)

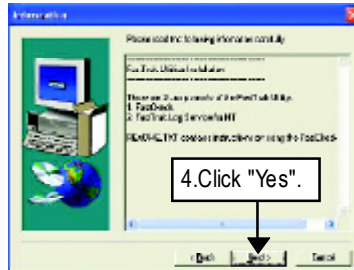

(4)



(5)



(6)



(7)



(8)



(9)



(10)

D-5: ATA133 Driver setup **



(1)

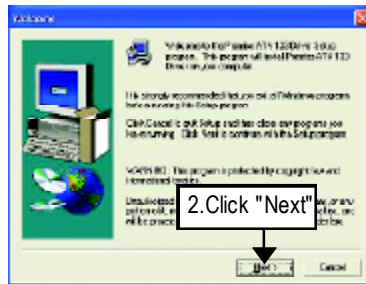

(2)



(3)

** " FOR GA-7VAXP / GA-7VAXP Ultra Only.

Appendix B: RealTek AC'97 Audio Driver

Insert the driver CD-tite that came with your motherboard into your CD-ROM driver, the driver CD-tite will auto start and show the installation guide. Ifnot, please double click the CD-ROM device icon in "Mycomputer", and execute the setup.exe.



(1)



(2)

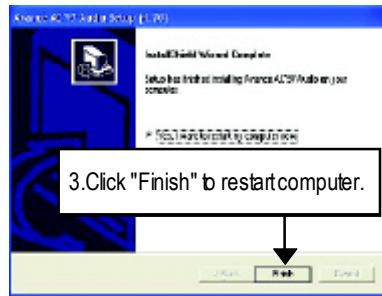

(3)

Appendix C : RealTek 8139/8100 Network Driver



(1)

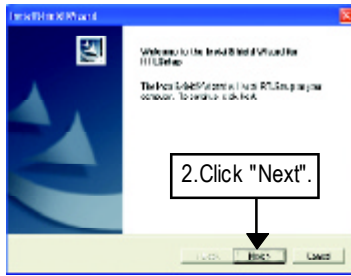

(2)

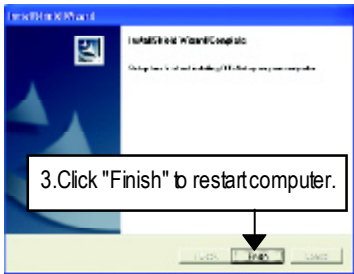

(3)

Appendix D: EasyTune4 Utilities Installation

Insert the driver CD-tile that came with your motherboard into your CD-ROM driver, the driver CD-tile will auto start and show the installation guide. If not please double click the CD-ROM device icon in "My computer", and execute the setup.exe.

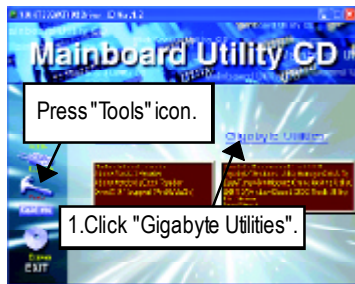

(1)



(2)



(3)

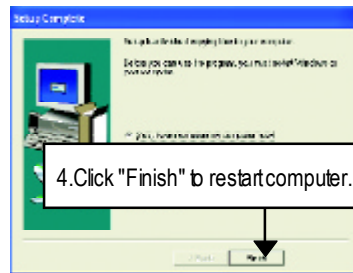

(4)

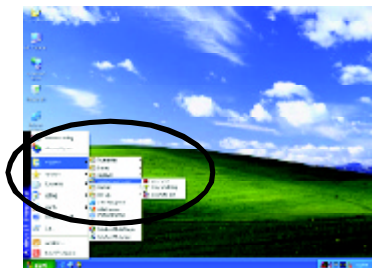

(5)

Appendix E: Acronyms

| Acronyms | Meaning |
|----------|---|
| ACPI | Advanced Configuration and Power Interface |
| APM | Advanced Power Management |
| AGP | Accelerated Graphics Port |
| AMR | Audio Modem Riser |
| ACR | Advanced Communications Riser |
| BIOS | Basic Input / Output System |
| CPU | Central Processing Unit |
| CMOS | Complementary Metal Oxide Semiconductor |
| CRIMM | Continuity RIMM |
| CNR | Communication and Networking Riser |
| DMA | Direct Memory Access |
| DMI | Desktop Management Interface |
| DIMM | Dual In-line Memory Module |
| DRM | Dual Retention Mechanism |
| DRAM | Dynamic Random Access Memory |
| DDR | Double Data Rate |
| ECP | Extended Capabilities Port |
| ESCD | Extended System Configuration Data |
| ECC | Error Checking and Correcting |
| EMC | Electromagnetic Compatibility |
| EPP | Enhanced Parallel Port |
| ESD | Electrostatic Discharge |
| FDD | Floppy Disk Device |
| FSB | Front Side Bus |
| HDD | Hard Disk Device |
| IDE | Integrated Dual Channel Enhanced |
| IRQ | Interrupt Request |
| I/O | Input / Output |
| IOAPIC | Input Output Advanced Programmable Input Controller |
| ISA | Industry Standard Architecture |
| LAN | Local Area Network |

to be continued.....

| Acronyms | Meaning |
|----------|--------------------------------------|
| LBA | Logical Block Addressing |
| LED | Light Emitting Diode |
| MHz | Megahertz |
| MIDI | Musical Instrument Digital Interface |
| MTH | Memory Translator Hub |
| MPT | Memory Protocol Translator |
| NIC | Network Interface Card |
| OS | Operating System |
| OEM | Original Equipment Manufacturer |
| PAC | PCI A.G.P. Controller |
| POST | Power-On Self Test |
| PCI | Peripheral Component Interconnect |
| RIMM | Rambus in-line Memory Module |
| SCI | Special Circumstance Instructions |
| SECC | Single Edge Contact Cartridge |
| SRAM | Static Random Access Memory |
| SMP | Symmetric Multi-Processing |
| SMI | System Management Interrupt |
| USB | Universal Serial Bus |
| VID | Voltage ID |

Technical Support/RMA Sheet

| | | |
|-------------------|---------------|------------|
| Customer/Country: | Company: | Phone No.: |
| Contact Person: | E-mail Add. : | |

| | |
|-----------------------|---------------|
| Modelname/Lot Number: | PCB revision: |
| BIOS version: | O.S./A.S.: |

| Hardware Configuration | Mfs. | Modelname | Size: | Driver/Utility: |
|------------------------|------|-----------|-------|-----------------|
| CPU | | | | |
| Memory Brand | | | | |
| Video Card | | | | |
| Audio Card | | | | |
| HDD | | | | |
| CD-ROM / DVD-ROM | | | | |
| Modem | | | | |
| Network | | | | |
| AMR / CNR | | | | |
| Keyboard | | | | |
| Mouse | | | | |
| Power supply | | | | |
| Other Device | | | | |
| | | | | |
| | | | | |
| | | | | |

Problem Description:

DDR400 (PC3200) recommended memory modules list

| Vender | Brand | Type | Size | Component | Status |
|---------|---------|------|-------|---------------------|--------|
| Kingmax | Kingmax | DDR | 128MB | KDL684T4AA-50 | OK |
| MICRON | MICRON | DDR | 128MB | M8VDDT1664AG-403B2 | OK |
| Hynix | Hynix | DDR | 128MB | HY5DU28822BT-04 | OK |
| SAMSUNG | SAMSUNG | DDR | 128MB | K4H280838D-TCC4 | OK |
| Kingmax | Kingmax | DDR | 256MB | KDL684T4AA-50 | OK |
| MICRON | MICRON | DDR | 256MB | M16VDDT3264AG-403B2 | OK |
| Hynix | Hynix | DDR | 256MB | HY5DU28822BT-04 | OK |
| ADATA | Winbond | DDR | 256MB | W942508BH-52260D | OK |
| SAMSUNG | SAMSUNG | DDR | 256MB | K4H560838D-TCC4 223 | OK |
| APACER | Winbond | DDR | 256MB | W942508BH-52260D | OK |
| Winbond | Winbond | DDR | 256MB | W942508BH-52110A | OK |
| Winbond | Winbond | DDR | 256MB | W942508BH-52150D | OK |
| ADATA | Winbond | DDR | 256MB | W942508BH-52260D | OK |
| APACER | Winbond | DDR | 256MB | W942508BH-52260D | OK |

● Should you need to find new support list, pls refer to
<http://www.gigabyte.com.tw> for the detail.
